

In collaborazione con

Palmako

LEMEKS GROUP



ESTERNI DA VIVERE

Catalogo
prodotti
2026



Indice

| | |
|--|-----|
| La collaborazione tra Losa e Palmako | 4 |
| Casette impregnate color marrone | 5 |
| Casette non impregnate | 11 |
| Casette per bambini | 27 |
| Carport | 33 |
| Relax in giardino | 35 |
| Linea Easyline | 38 |
| Recinzioni | 51 |
| Accessori | 55 |
| Casette con serramenti in alluminio | 59 |
| Casette con serramenti in alluminio scorrevole | 63 |
| Tiny House | 68 |
| Casette tradizionali falda singola | 72 |
| Casette tradizionali falda doppia | 76 |
| Giardini d'inverno | 82 |
| Pavilion e Chioschi | 86 |
| Kota Grill | 90 |
| Pergole e Gazebo | 92 |
| Strutture componibili | 96 |
| Saune | 104 |
| Portattrezzi | 108 |
| Garage e Carport | 113 |
| Giochi per bambini | 120 |
| Mobili da giardino | 125 |
| WPC | 127 |
| Dropshipping, condizioni di consegna al cliente finale | 132 |
| Verniciatura, colorazioni | 133 |
| Impregnazione, colorazioni | 133 |
| Descrizione dei simboli | 134 |

La collaborazione tra Losa e Palmako



Palmako

LEMEKS GROUP

La collaborazione tra **Losa - Esterni da Vivere** e **Palmako** unisce l'esperienza pluridecennale di Palmako nella produzione di strutture in legno alla competenza organizzativa di Losa, che da oltre dieci anni opera con successo con il servizio **dropshipping** nel settore outdoor.

Grazie a questo modello consolidato, Losa offre ai propri rivenditori l'intera gamma Palmako senza necessità di stock, garantendo consegne rapide, gestione semplificata e un servizio affidabile.

Insieme, Losa e Palmako propongono soluzioni complete, moderne e di alta qualità per l'arredo e le strutture da giardino.



CASETTE IMPREGNATE COLOR MARRONE

Le nostre casette impregnate a pressione color marrone sono il giusto connubio tra la naturalità del legno e la durata nel tempo. Dopo la realizzazione, i diversi componenti vengono inseriti nell'autoclave, con sali impregnanti. Il legno, completamente immerso e sottoposto ad una forte pressione, esce dall'autoclave protetto in ogni sua parte. Dopo la "stabilizzazione" in uno speciale essiccatore ed il confezionamento, la casetta è pronta per essere installata e durare nel tempo.

01



Valentine A 296 x 200 | mm 28

Articolo numero
109452

Materiale
Legno di abete impregnato a pressione **color marrone**

In pronta consegna 



STRUTTURA

Tipologia costruttiva
Blockhouse

Spessore pareti
28 mm

Perline del tetto
16 mm

DIMENSIONI

Dimensioni a terra
296 x 200 cm

Dimensioni interne
270 x 174 cm

Altezza parete
194 cm

Altezza totale
236 cm

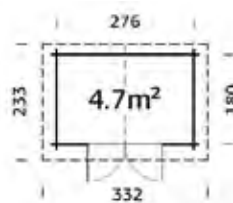

PORTE

1 porta doppia cm 149 x 182 h,
vetro singolo 4 mm

DOTAZIONI

Pavimento
Optional

Impermeabilizzazione
Optional

SERVIZI

Scarico con sponda idraulica
 Non disponibile

Dropshipping
 Disponibile, vedi condizioni a pag. 132

IMBALLO

Dimensione
cm 320 x 118 x 51 h

Peso lordo
548 kg

OPTIONAL CONSIGLIATI

Pavimento: art. nr. 109456
Guaina ardesiata: nr. 2 rotoli
Tegole canadesi: nr. 4 confezioni
Kit grondaia "B"
Finitura cerata: nr. 2 confezioni

Arisa 250 x 250 | mm 28

 Articolo numero
108692

Materiale

 Legno di abete impregnato a pressione **color marrone**

 In pronta consegna 

STRUTTURA
Tipologia costruttiva
 Blockhouse

Spessore pareti
 28 mm

Perline del tetto
 16 mm

DIMENSIONI
Dimensioni a terra
 250 x 250 cm

Dimensioni interne
 224 x 224 cm

Altezza parete
 194 cm

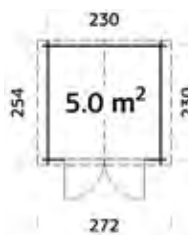
Altezza totale
 230 cm

PORTE

 1 porta doppia cm 149 x 182 h,
 vetro singolo 4 mm

DOTAZIONI
Pavimento
 Optional

Impermeabilizzazione
 Cartongfeltro bitumato

SERVIZI
Scarico con sponda idraulica
 Non disponibile

Dropshipping
 Disponibile, vedi condizioni a pag. 132

IMBALLO
Dimensione
 cm 260 x 118 x 52 h

Peso lordo
 460 kg

OPTIONAL CONSIGLIATI

 Pavimento: art. nr. 102870
 Guaina ardesiata: nr. 2 rotoli
 Tegole canadesi: nr. 3 confezioni
 Kit grondaia "B"
 Finitura cerata: nr. 2 confezioni

Rita 296 x 296 | mm 28

 Articolo numero
109219

Materiale

 Legno di abete impregnato a pressione **color marrone**

 In pronta consegna 

STRUTTURA
Tipologia costruttiva
 Blockhouse

Spessore pareti
 28 mm

Perline del tetto
 16 mm

DIMENSIONI
Dimensioni a terra
 296 x 296 cm

Dimensioni interne
 270 x 270 cm

Altezza parete
 194 cm

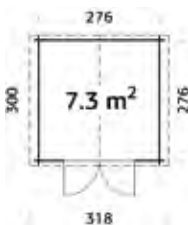
Altezza totale
 235 cm

PORTE

 1 porta doppia cm 149 x 182 h,
 vetro singolo 4 mm

DOTAZIONI
Pavimento
 Optional

Impermeabilizzazione
 Cartongfeltro bitumato

SERVIZI
Scarico con sponda idraulica
 Non disponibile

Dropshipping
 Disponibile, vedi condizioni a pag. 132

IMBALLO
Dimensione
 cm 320 x 118 x 54 h

Peso lordo
 540 kg

OPTIONAL CONSIGLIATI

 Pavimento: art. nr. 102912
 Guaina ardesiata: nr. 2 rotoli
 Tegole canadesi: nr. 4 confezioni
 Kit grondaia "C"
 Finitura cerata: nr. 3 confezioni

Valentine B 358 x 296 | mm 28

Articolo numero
109458



Materiale

Legno di abete impregnato a pressione **color marrone**

In pronta consegna 



STRUTTURA

Tipologia costruttiva
Blockhouse

Spessore pareti
28 mm

Perline del tetto
16 mm

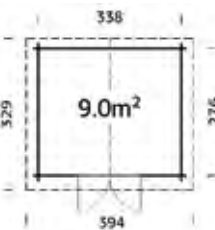

DIMENSIONI

Dimensioni a terra
358 x 296 cm

Dimensioni interne
332 x 270 cm

Altezza parete
194 cm

Altezza totale
235 cm

PORTE

1 porta doppia cm 149 x 182 h,
vetro singolo mm 4

DOTAZIONI

Pavimento
Optional

Impermeabilizzazione
Optional

SERVIZI

Scarico con sponda idraulica

☒ Non disponibile

Dropshipping

☑ Disponibile, vedi condizioni a pag. 132

IMBALLO

Dimensione
cm 445 x 118 x 42 h

Peso lordo
597 kg

OPTIONAL CONSIGLIATI

Pavimento: art. nr. 109518
Guaina ardesiata: nr. 3 rotoli
Tegole canadesi: nr. 6 confezioni
Kit grondaia "D"
Finitura cerata: nr. 3 confezioni

Lola A 322 x 292 | mm 28

Articolo numero
119257



Materiale

Legno di abete impregnato a pressione **color marrone**

In pronta consegna 



STRUTTURA

Tipologia costruttiva
Blockhouse

Spessore pareti
28 mm

Perline del tetto
16 mm

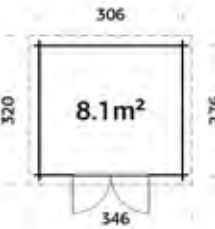

DIMENSIONI

Dimensioni a terra
322 x 292 cm

Dimensioni interne
300 x 270 cm

Altezza parete
188 cm

Altezza totale
215 cm

PORTE

1 porta doppia cm 161 x 183 h,
vetro singolo 4 mm

DOTAZIONI

Pavimento
Optional

Impermeabilizzazione
Cartonfeltro bitumato

SERVIZI

Scarico con sponda idraulica

☒ Non disponibile

Dropshipping

☑ Disponibile, vedi condizioni a pag. 132

IMBALLO

Dimensione
cm 445 x 118 x 46 h

Peso lordo
530 kg

OPTIONAL CONSIGLIATI

Pavimento: art. nr. 120511
Guaina ardesiata: nr. 2 rotoli
Kit grondaia "D"
Finitura cerata: nr. 3 confezioni

Lola B 406 x 292 | mm 28

Articolo numero
119258



Materiale

Legno di abete impregnato a pressione **color marrone**

In pronta consegna 



STRUTTURA

Tipologia costruttiva
Blockhouse

Spessore pareti
28 mm

Perline del tetto
16 mm

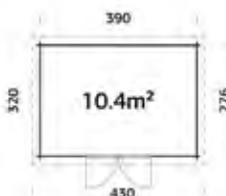

DIMENSIONI

Dimensioni a terra
406 x 292 cm

Dimensioni interne
384 x 270 cm

Altezza parete
188 cm

Altezza totale
215 cm

PORTE

1 porta doppia cm 161 x 183 h,
vetro singolo 4 mm

DOTAZIONI

Pavimento
Optional

Impermeabilizzazione
Cartonfeltro bitumato

SERVIZI

Scarico con sponda idraulica

☒ Non disponibile

Dropshipping

☑ Disponibile, vedi condizioni a pag. 132

IMBALLO

Dimensione
cm 445 x 118 x 54 h

Peso lordo
590 kg

OPTIONAL CONSIGLIATI

Pavimento: art. nr. 102932
Guaina ardesiata: nr. 2 rotoli
Kit grondaia "D"
Finitura cerata: nr. 3 confezioni

Paola 206 x 176 | mm 19

Articolo numero
109157



Materiale

Legno di abete impregnato a pressione **color marrone**

In pronta consegna 



STRUTTURA

Tipologia costruttiva
Blockhouse

Spessore pareti
19 mm

Perline del tetto
16 mm

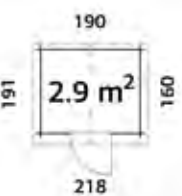

DIMENSIONI

Dimensioni a terra
206 x 176 cm

Dimensioni interne
186 x 156 cm

Altezza parete
176 cm

Altezza totale
218 cm

PORTE

Porte

1 porta singola cm 80 x 167 h,
plexiglass

DOTAZIONI

Pavimento
Optional

Impermeabilizzazione
Cartonfeltro bitumato

SERVIZI

Scarico con sponda idraulica

☑ Disponibile

Dropshipping

☑ Disponibile, vedi condizioni a pag. 132

IMBALLO

Dimensione
cm 240 x 118 x 37 h

Peso lordo
270 kg

OPTIONAL CONSIGLIATI

Pavimento: art. nr. 108699
Guaina ardesiata: nr. 1 rotolo
Tegole canadesi: nr. 2 confezioni
Kit grondaia "A"
Finitura cerata: nr. 1 confezione

Pablo 3 296 x 200 | mm 19

Articolo numero
119259

Materiale
Legno di abete impregnato a pressione **color marrone**

In pronta consegna 



STRUTTURA

Tipologia costruttiva
Blockhouse

Spessore pareti
19 mm

Perline del tetto
16 mm

DIMENSIONI

Dimensioni a terra
296 x 200 cm

Dimensioni interne
276 x 180 cm

Altezza parete
177 cm

Altezza totale
217 cm

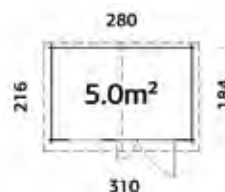

PORTE e FINESTRE

Porte
1 porta doppia cm 120 x 162 h

Finestre
1 finestra singola cm 64 x 54 h,
plexiglass

DOTAZIONI

Pavimento
Optional

Impermeabilizzazione
Cartonfeltro bitumato

SERVIZI

Scarico con sponda idraulica
 Non disponibile

Dropshipping
 Disponibile, vedi condizioni a pag. 132

IMBALLO

Dimensione
cm 320 x 118 x 36 h

Peso lordo
572 kg

OPTIONAL CONSIGLIATI

Pavimento: art. nr. 109456
Guaina ardesiata: nr. 2 rotoli
Tegole canadesi: nr. 3 confezioni
Kit grondaia "A"
Finitura cerata: nr. 2 confezioni

Zoe A 176 x 176 | mm 19

Articolo numero
119255

Materiale
Legno di abete impregnato a pressione **color marrone**

In pronta consegna 



STRUTTURA

Tipologia costruttiva
Blockhouse

Spessore pareti
19 mm

Perline del tetto
16 mm

DIMENSIONI

Dimensioni a terra
176 x 176 cm

Dimensioni interne
154 x 154 cm

Altezza parete
194 cm

Altezza totale
208 cm

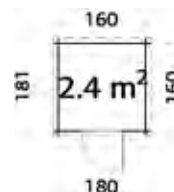

PORTE

1 porta singola cm 74 x 171 h,
plexiglass

DOTAZIONI

Pavimento
Optional

Impermeabilizzazione
Cartonfeltro bitumato

SERVIZI

Scarico con sponda idraulica
 Disponibile

Dropshipping
 Disponibile, vedi condizioni a pag. 132

IMBALLO

Dimensione
cm 190 x 118 x 27 h

Peso lordo
270 kg

OPTIONAL CONSIGLIATI

Pavimento: art. nr. 120499
Guaina ardesiata: nr. 1 rotolo
Kit grondaia "A"
Finitura cerata: nr. 1 confezione

Zoe B 216 x 216 | mm 19

Articolo numero
120255



Materiale

Legno di abete impregnato a pressione **color marrone**

In pronta consegna



STRUTTURA

Tipologia costruttiva
Blockhouse

Spessore pareti
19 mm

Perline del tetto
16 mm

DIMENSIONI

Dimensioni a terra
216 x 216 cm

Dimensioni interne
196 x 196 cm

Altezza parete
194 cm

Altezza totale
208 cm

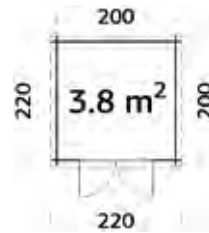

PORTE

1 porta doppia cm 125 x 162 h, plexiglass

DOTAZIONI

Pavimento
Optional

Impermeabilizzazione
Cartonfeltro bitumato

SERVIZI

Scarico con sponda idraulica
 Disponibile

Dropshipping
 Disponibile, vedi condizioni a pag. 132

IMBALLO

Dimensione
cm 240 x 118 x 42 h

Peso lordo
300 kg

OPTIONAL CONSIGLIATI

Pavimento: art. nr. 120503
Guaina ardesiata: nr. 1 rotolo
Kit grondaia "B"
Finitura cerata: nr. 2 confezioni

Zoe C 260 x 260 | mm 19

Articolo numero
119256



Materiale

Legno di abete impregnato a pressione **color marrone**

In pronta consegna



STRUTTURA

Tipologia costruttiva
Blockhouse

Spessore pareti
19 mm

Perline del tetto
16 mm

DIMENSIONI

Dimensioni a terra
260 x 260 cm

Dimensioni interne
240 x 240 cm

Altezza parete
194 cm

Altezza totale
208 cm

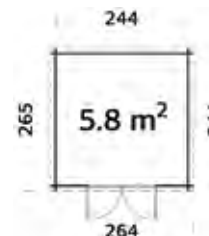

PORTE

1 porta doppia cm 125 x 162 h, plexiglass

DOTAZIONI

Pavimento
Optional

Impermeabilizzazione
Cartonfeltro bitumato

SERVIZI

Scarico con sponda idraulica
 Non disponibile

Dropshipping
 Disponibile, vedi condizioni a pag. 132

IMBALLO

Dimensione
cm 320 x 118 x 38 h

Peso lordo
370 kg

OPTIONAL CONSIGLIATI

Pavimento: art. nr. 121459
Guaina ardesiata: nr. 1 rotolo
Kit grondaia "C"
Impregnante: nr. 2 confezioni

CASSETTE NON IMPREGNATE



Vivian 218 x 218 | mm 28

Articolo numero
101314

Materiale
Abete non trattato

In pronta consegna 



STRUTTURA

Tipologia costruttiva
Blockhouse

Spessore pareti
28 mm

Perline del tetto
19 mm

DIMENSIONI

Dimensioni a terra
218 x 218 cm

Dimensioni interne
194 x 194 cm

Altezza parete
194 cm

Altezza totale
229 cm

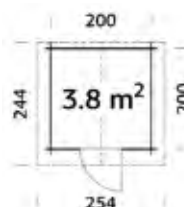

PORTE

1 porta singola cm 83 x 182 h,
vetro singolo 4 mm

DOTAZIONI

Pavimento
19 mm

Impermeabilizzazione
Optional

SERVIZI

Scarico con sponda idraulica
 Non Disponibile

Dropshipping
 Disponibile, vedi condizioni a pag. 132

IMBALLO

Dimensione
cm 260 x 120 x 50 h

Peso lordo
410 kg

OPTIONAL CONSIGLIATI

Guaina ardesiata: nr. 1 rotoli
Tegole canadesi: nr. 3 confezioni
Kit grondaia "B"
Impregnante: nr. 2 confezioni

Noemi 250 x 250 | mm 28

Articolo numero
101437

Materiale
Abete non trattato

In pronta consegna 



STRUTTURA

Tipologia costruttiva
Blockhouse

Spessore pareti
28 mm

Perline del tetto
16 mm

DIMENSIONI

Dimensioni a terra
250 x 250 cm

Dimensioni interne
224 x 224 cm

Altezza parete
194 cm

Altezza totale
230 cm

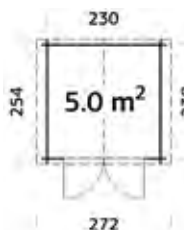

PORTE

1 porta doppia cm 149 x 182 h,
vetro singolo 4 mm

DOTAZIONI

Pavimento
Optional

Impermeabilizzazione
Cartonfeltro bitumato

SERVIZI

Scarico con sponda idraulica
 Non Disponibile

Dropshipping
 Disponibile, vedi condizioni a pag. 132

IMBALLO

Dimensione
cm 260 x 118 x 52 h

Peso lordo
400 kg

OPTIONAL CONSIGLIATI

Pavimento: art. nr. 102870
Guaina ardesiata: nr. 2 rotoli
Tegole canadesi: nr. 3 confezioni
Kit grondaia "B"
Impregnante: nr. 2 confezioni

Astrid 296 x 296 | mm 28

Articolo numero
101511

Materiale
Abete non trattato

In pronta consegna 



STRUTTURA

Tipologia costruttiva
Blockhouse

Spessore pareti
28 mm

Perline del tetto
16 mm

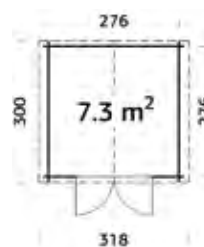

DIMENSIONI

Dimensioni a terra
296 x 296 cm

Dimensioni interne
270 x 270 cm

Altezza parete
194 cm

Altezza totale
235 cm

PORTE

1 porta doppia cm 149 x 182 h,
vetro singolo 4 mm

DOTAZIONI

Pavimento
Optional

Impermeabilizzazione
Cartonfeltro bitumato

SERVIZI

Scarico con sponda idraulica

☒ Non disponibile

Dropshipping

☑ Disponibile, vedi condizioni a pag. 132

IMBALLO

Dimensione
cm 320 x 118 x 54 h

Peso lordo
485 kg

OPTIONAL CONSIGLIATI

Pavimento: art. nr. 102912
Guaina ardesiata: nr. 2 rotoli
Tegole canadesi: nr. 4 confezioni
Kit grondaia "C"
Impregnante: nr. 3 confezioni

Lya A 276 x 282 | mm 28

Articolo numero
119235

Materiale
Abete non trattato

In pronta consegna 



STRUTTURA

Tipologia costruttiva
Perline ad incastro

Spessore pareti
28 mm

Perline del tetto
16 mm

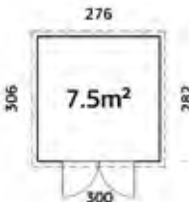

DIMENSIONI

Dimensioni a terra
276 x 282 cm

Dimensioni interne
270 x 276 cm

Altezza parete
211 cm

Altezza totale
221 cm

PORTE

1 porta doppia cm 160 x 178 h,
vetro singolo 4 mm

DOTAZIONI

Pavimento
Optional

Impermeabilizzazione
Cartonfeltro bitumato

SERVIZI

Scarico con sponda idraulica

☒ Non Disponibile

Dropshipping

☑ Disponibile, vedi condizioni a pag. 132

IMBALLO

Dimensione
cm 320 x 118 x 60 h

Peso lordo
500 kg

OPTIONAL CONSIGLIATI

Pavimento: art. nr. 120515
Guaina ardesiata: nr. 2 rotoli
Kit grondaia "D"
Impregnante: nr. 3 confezioni

Lya B 385 x 282 | mm 28

Articolo numero
119239

Materiale
Abete non trattato

In pronta consegna 



STRUTTURA

Tipologia costruttiva
Perline ad incastro

Spessore pareti
28 mm

Perline del tetto
16 mm

DIMENSIONI

Dimensioni a terra
385 x 282 cm

Dimensioni interne
379 x 276 cm

Altezza parete
211 cm

Altezza totale
221 cm

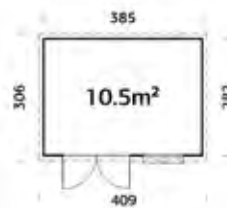

PORTE e FINESTRE

Porte
1 porta doppia cm 160 x 178 h,
vetro singolo 4 mm

Finestre
1 finestra singola cm 80 x 54 h,
vetro singolo 4 mm

DOTAZIONI

Pavimento
Optional

Impermeabilizzazione
Cartonfeltro bitumato

SERVIZI

Scarico con sponda idraulica
 Non disponibile

Dropshipping
 Disponibile, vedi condizioni a pag. 132

IMBALLO

Dimensione
cm 445 x 118 x 55 h

Peso lordo
660 kg

OPTIONAL CONSIGLIATI

Pavimento: art. nr. 120519
Guaina ardesiata: nr. 2 rotoli
Kit grondaia "D"
Impregnante: nr. 3 confezioni

Nora A 322 x 292 | mm 28

Articolo numero
119227

Materiale
Abete non trattato

In pronta consegna 



STRUTTURA

Tipologia costruttiva
Blockhouse

Spessore pareti
28 mm

Perline del tetto
16 mm

DIMENSIONI

Dimensioni a terra
322 x 292 cm

Dimensioni interne
300 x 270 cm

Altezza parete
188 cm

Altezza totale
215 cm

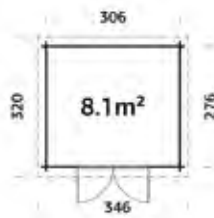

PORTE

1 porta doppia cm 161 x 183 h,
vetro singolo 4 mm

DOTAZIONI

Pavimento
Optional

Impermeabilizzazione
Cartonfeltro bitumato

SERVIZI

Scarico con sponda idraulica
 Non Disponibile

Dropshipping
 Disponibile, vedi condizioni a pag. 132

IMBALLO

Dimensione
cm 445 x 118 x 46 h

Peso lordo
530 kg

OPTIONAL CONSIGLIATI

Pavimento: art. nr. 120511
Guaina ardesiata: nr. 2 rotoli
Kit grondaia "D"
Impregnante: nr. 3 confezioni

Nora B 406 x 292 | mm 28

Articolo numero
119231

Materiale
Abete non trattato

In pronta consegna 



STRUTTURA

Tipologia costruttiva
Blockhouse

Spessore pareti
28 mm

Perline del tetto
16 mm

DIMENSIONI

Dimensioni a terra
406 x 292 cm

Dimensioni interne
384 x 270 cm

Altezza parete
188 cm

Altezza totale
215 cm

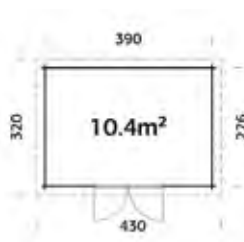

PORTE

1 porta doppia cm 161 x 183 h,
vetro singolo 4 mm

DOTAZIONI

Pavimento
Optional

Impermeabilizzazione
Cartonfeltro bitumato

SERVIZI

Scarico con sponda idraulica

☒ Non disponibile

Dropshipping

☑ Disponibile, vedi condizioni a pag. 132

IMBALLO

Dimensione
cm 445 x 118 x 54 h

Peso lordo
590 kg

OPTIONAL CONSIGLIATI

Pavimento: art. nr. 102932
Guaina ardesiata: nr. 2 rotoli
Kit grondaia "D"
Impregnante: nr. 3 confezioni

Lydia A 285 x 291 | mm 28

Articolo numero
111034

Materiale
Abete non trattato

In pronta consegna 



STRUTTURA

Tipologia costruttiva
Perline ad incastro

Spessore pareti
28 mm

Perline del tetto
16 mm

DIMENSIONI

Dimensioni a terra
285 x 291 cm

Dimensioni interne
279 x 285 cm

Altezza parete
222 cm

Altezza totale
237 cm

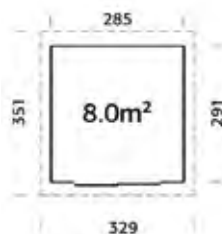

PORTE

1 porta scorrevole in alluminio
cm 185 x 191 h, vetro singolo
temperato 4 mm

DOTAZIONI

Pavimento
Optional

Impermeabilizzazione
Cartonfeltro bitumato

SERVIZI

Scarico con sponda idraulica

☒ Non disponibile

Dropshipping

☑ Disponibile, vedi condizioni a pag. 132

IMBALLO

Dimensione
cm 445 x 118 x 53 h

Peso lordo
580 kg

OPTIONAL CONSIGLIATI

Pavimento: art. nr. 111730
Guaina ardesiata: nr. 2 rotoli
Guaina EPDM: nr. 1 rotolo
Kit grondaia "E"
Impregnante: nr. 3 confezioni

Lydia B 385 x 291 | mm 28

Articolo numero
111010

Materiale
Abete non trattato

In pronta consegna 



STRUTTURA

Tipologia costruttiva
Perline ad incastro

Spessore pareti
28 mm

Perline del tetto
16 mm

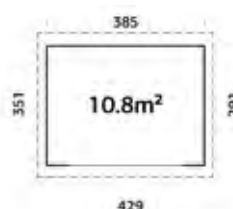

DIMENSIONI

Dimensioni a terra
385 x 291 cm

Dimensioni interne
379 x 285 cm

Altezza parete
222 cm

Altezza totale
237 cm

PORTE

1 porta scorrevole in alluminio
cm 274 x 191 h, vetro singolo
temperato 4 mm

DOTAZIONI

Pavimento
Optional

Impermeabilizzazione
Cartonfeltro bitumato

SERVIZI

Scarico con sponda idraulica
 Non disponibile

Dropshipping
 Disponibile, vedi condizioni a pag. 132

IMBALLO

Dimensione
cm 445 x 118 x 56 h

Peso lordo
802 kg

OPTIONAL CONSIGLIATI

Pavimento: art. nr. 111726
Guaina ardesiata: nr. 2 rotoli
Guaina EPDM: nr. 2 rotoli
Kit grondaia "E"
Impregnante: nr. 3 confezioni

Lydia C 450 x 330 | mm 28

Articolo numero
111042

Materiale
Abete non trattato

In pronta consegna 



STRUTTURA

Tipologia costruttiva
Perline ad incastro

Spessore pareti
28 mm

Perline del tetto
16 mm

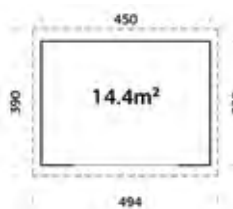

DIMENSIONI

Dimensioni a terra
450 x 330 cm

Dimensioni interne
444 x 324 cm

Altezza parete
222 cm

Altezza totale
237 cm

PORTE

1 porta scorrevole in alluminio
cm 274 x 191 h, vetro singolo
temperato 4 mm

DOTAZIONI

Pavimento
Optional

Impermeabilizzazione
Cartonfeltro bitumato

SERVIZI

Scarico con sponda idraulica
 Non disponibile

Dropshipping
 Disponibile, vedi condizioni a pag. 132

IMBALLO

Dimensione
cm 600 x 118 x 53 h

Peso lordo
810 kg

OPTIONAL CONSIGLIATI

Pavimento: art. nr. 111713
Guaina ardesiata: nr. 5 rotoli
Guaina EPDM: nr. 2 rotoli
Kit grondaia "E"
Impregnante: nr. 4 confezioni

Klara 380 x 320 | mm 28

Articolo numero
101990

Materiale
Abete non trattato

In pronta consegna 



STRUTTURA

Tipologia costruttiva
Blockhouse

Spessore pareti
28 mm

Perline del tetto
16 mm

DIMENSIONI

Dimensioni a terra
380 x 320 cm

Dimensioni interne
354 x 294 cm

Altezza parete
194 cm

Altezza totale
247 cm

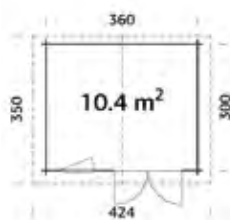

PORTE e FINESTRE

Porte
1 porta doppia cm 149 x 182 h,
vetro singolo 4 mm

Finestre
1 finestra singola cm 76 x 99 h,
vetro singolo 4 mm

DOTAZIONI

Pavimento
Optional

Impermeabilizzazione
Optional

SERVIZI

Scarico con sponda idraulica
 Non disponibile

Dropshipping
 Disponibile, vedi condizioni a pag. 132

IMBALLO

Dimensione
cm 445 x 118 x 52 h

Peso lordo
555 kg

OPTIONAL CONSIGLIATI

Pavimento: art. nr. 103011
Guaina ardesiata: nr. 3 rotoli
Tegole canadesi: nr. 6 confezioni
Kit grondaia "E"
Impregnante: nr. 3 confezioni

Lotta A 296 x 296 | mm 28

Articolo numero
101482

Materiale
Abete non trattato

In pronta consegna 



STRUTTURA

Tipologia costruttiva
Blockhouse

Spessore pareti
28 mm

Perline del tetto
16 mm

DIMENSIONI

Dimensioni a terra
296 x 296 cm

Dimensioni interne
270 x 270 cm

Altezza parete
194 cm

Altezza totale
247 cm

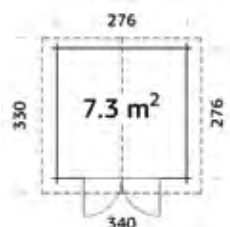

PORTE

1 porta doppia cm 161 x 182 h,
vetro singolo 4 mm

DOTAZIONI

Pavimento
Optional

Impermeabilizzazione
Optional

SERVIZI

Scarico con sponda idraulica
 Non disponibile

Dropshipping
 Disponibile, vedi condizioni a pag. 132

IMBALLO

Dimensione
cm 440 x 120 x 50 h

Peso lordo
530 kg

OPTIONAL CONSIGLIATI

Pavimento: art. nr. 102971
Guaina ardesiata: nr. 3 rotoli
Tegole canadesi: nr. 5 confezioni
Kit grondaia "D"
Impregnante: nr. 3 confezioni

Lotta B 400 x 400 | mm 34

Articolo numero
101694

Materiale
Abete non trattato

In pronta consegna 



STRUTTURA

Tipologia costruttiva
Blockhouse

Spessore pareti
34 mm

Perline del tetto
16 mm

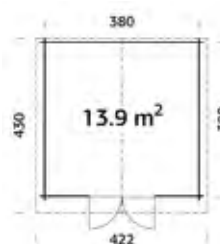

DIMENSIONI

Dimensioni a terra
400 x 400 cm

Dimensioni interne
373 x 373 cm

Altezza parete
182 cm

Altezza totale
245 cm

PORTE

1 porta doppia cm 161 x 182 h,
vetro singolo 4 mm

DOTAZIONI

Pavimento
Optional

Impermeabilizzazione
Optional

SERVIZI

Scarico con sponda idraulica
 Non disponibile

Dropshipping
 Disponibile, vedi condizioni a pag. 132

IMBALLO

Dimensione
cm 445 x 118 x 53 h

Peso lordo
814 kg

OPTIONAL CONSIGLIATI

Pavimento: art. nr. 103030
Guaina ardesiata: nr. 3 rotoli
Tegole canadesi: nr. 8 confezioni
Kit grondaia "F"
Impregnante: nr. 4 confezioni

Britta A 446 x 446 | mm 40

Articolo numero
102252

Materiale
Abete non trattato

In pronta consegna 



STRUTTURA

Tipologia costruttiva
Blockhouse

Spessore pareti
40 mm

Perline del tetto
mm 19

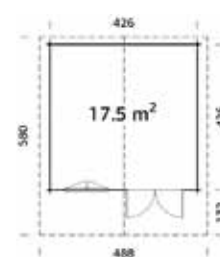

DIMENSIONI

Dimensioni a terra
446 x 446 cm

Dimensioni interne
418 x 418 cm

Altezza parete
205 cm

Altezza totale
270 cm

PORTE e FINESTRE

Porte
1 porta doppia cm 161 x 193 h,
vetro singolo 4 mm

Finestre
1 finestra doppia cm 129 x 99 h,
vetro singolo 4 mm

DOTAZIONI

Pavimento
Optional

Impermeabilizzazione
Optional

SERVIZI

Scarico con sponda idraulica
 Non disponibile

Dropshipping
 Disponibile, vedi condizioni a pag. 132

IMBALLO

Dimensione
cm 600 x 118 x 65 h

Peso lordo
1245 kg

OPTIONAL CONSIGLIATI

Pavimento: art. nr. 103050
Guaina ardesiata: nr. 7 rotoli
Tegole canadesi: nr. 11 confezioni
Kit grondaia "G"
Impregnante: nr. 4 confezioni

Britta B 500 x 445 | mm 40

Articolo numero
102262

Materiale
Abete non trattato

In pronta consegna 



STRUTTURA

Tipologia costruttiva
Blockhouse

Spessore pareti
40 mm

Perline del tetto
mm 19

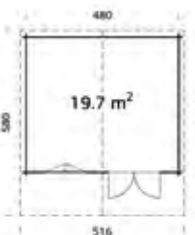

DIMENSIONI

Dimensioni a terra
500 x 445 cm

Dimensioni interne
472 x 417 cm

Altezza parete
205 cm

Altezza totale
270 cm

PORTE e FINESTRE

Porte

1 porta doppia cm 161 x 193 h,
vetro singolo 4 mm

Finestre

1 finestra doppia cm 129 x 99 h,
vetro singolo 4 mm

DOTAZIONI

Pavimento
Optional

Impermeabilizzazione
Optional

SERVIZI

Scarico con sponda idraulica

 Non disponibile

Dropshipping

 Disponibile, vedi condizioni a pag. 132

IMBALLO

Dimensione
cm 600 x 118 x 65 h

Peso lordo
1315 kg

OPTIONAL CONSIGLIATI

Pavimento: art. nr. 103066
Guaina ardesiata: nr. 7 rotoli
Tegole canadesi: nr. 12 confezioni
Kit grondaia "G"
Impregnante: nr. 5 confezioni

Garage Tony 350 x 520 | mm 34

Articolo numero
102330

Materiale
Abete non trattato

In pronta consegna 



STRUTTURA

Tipologia costruttiva
Blockhouse

Spessore pareti
34 mm

Perline del tetto
16 mm



DIMENSIONI

Dimensioni a terra
350 x 520 cm

Dimensioni interne
323 x 493 cm

Altezza parete
217 cm

Altezza totale
268 cm

PORTE e FINESTRE

Porte

1 portone in legno cm 229 x 188 h
1 porta singola cm 83 x 178 h,
vetro singolo 4 mm

Finestre

1 finestra doppia cm 129 x 99 h,
vetro singolo 4 mm

DOTAZIONI

Impermeabilizzazione
Cartonfeltro bitumato

SERVIZI

Scarico con sponda idraulica

 Non disponibile

Dropshipping

 Disponibile, vedi condizioni a pag. 132

IMBALLO

Dimensione
cm 600 x 118 x 60 h

Peso lordo
955 kg

OPTIONAL CONSIGLIATI

Guaina ardesiata: nr. 5 rotoli
Tegole canadesi: nr. 10 confezioni
Kit grondaia "G"
Impregnante: nr. 5 confezioni

Mila 200 x 200 | mm 19

Articolo numero
121566

Materiale
Abete non trattato

In pronta consegna 



STRUTTURA

Tipologia costruttiva
Blockhouse

Spessore pareti
19 mm

Perline del tetto
16 mm

DIMENSIONI

Dimensioni a terra
200 x 200 cm

Dimensioni interne
176 x 176 cm

Altezza parete
176 cm

Altezza totale
218 cm

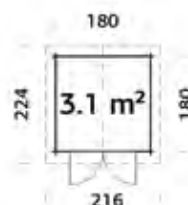

PORTE

1 porta doppia cm 125 x 161 h, plexiglass

DOTAZIONI

Pavimento
Optional

Impermeabilizzazione
Cartonfeltro bitumato

SERVIZI

Scarico con sponda idraulica
 Disponibile

Dropshipping
 Disponibile, vedi condizioni a pag. 132

IMBALLO

Dimensione
cm 200 x 120 x 40 h

Peso lordo
260 kg

OPTIONAL CONSIGLIATI

Pavimento: art. nr. 120503
Guaina ardesiata: nr. 1 rotolo
Tegole canadesi: nr. 3 confezioni
Kit grondaia "B"
Impregnante: nr. 1 confezione

Molly A 176 x 176 | mm 19

Articolo numero
119211

Materiale
Abete non trattato

In pronta consegna 



STRUTTURA

Tipologia costruttiva
Blockhouse

Spessore pareti
19 mm

Perline del tetto
16 mm

DIMENSIONI

Dimensioni a terra
176 x 176 cm

Dimensioni interne
154 x 154 cm

Altezza parete
194 cm

Altezza totale
208 cm

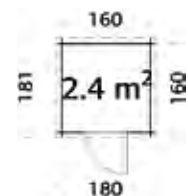

PORTE

1 porta singola cm 74 x 171 h, plexiglass

DOTAZIONI

Pavimento
Optional

Impermeabilizzazione
Cartonfeltro bitumato

SERVIZI

Scarico con sponda idraulica
 Disponibile

Dropshipping
 Disponibile, vedi condizioni a pag. 132

IMBALLO

Dimensione
cm 190 x 118 x 40 h

Peso lordo
230 kg

OPTIONAL CONSIGLIATI

Pavimento: art. nr. 120499
Guaina ardesiata: nr. 1 rotolo
Kit grondaia "A"
Impregnante: nr. 1 confezione

Molly B 216 x 216 | mm 19

Articolo numero
119215

Materiale
Abete non trattato

In pronta consegna 



STRUTTURA

Tipologia costruttiva
Blockhouse

Spessore pareti
19 mm

Perline del tetto
16 mm

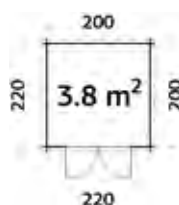

DIMENSIONI

Dimensioni a terra
216 x 216 cm

Dimensioni interne
196 x 196 cm

Altezza parete
194 cm

Altezza totale
208 cm

PORTE

1 porta doppia cm 125 x 162 h,
plexiglass

DOTAZIONI

Pavimento
Optional

Impermeabilizzazione
Cartonfeltro bitumato

SERVIZI

Scarico con sponda idraulica
 Disponibile

Dropshipping
 Disponibile, vedi condizioni a pag. 132

IMBALLO

Dimensione
cm 240 x 118 x 42 h

Peso lordo
300 kg

OPTIONAL CONSIGLIATI

Pavimento: art. nr. 120503
Guaina ardesiata: nr. 1 rotolo
Kit grondaia "B"
Impregnante: nr. 2 confezioni

Molly C 260 x 260 | mm 19

Articolo numero
119219

Materiale
Abete non trattato

In pronta consegna 



STRUTTURA

Tipologia costruttiva
Blockhouse

Spessore pareti
19 mm

Perline del tetto
16 mm

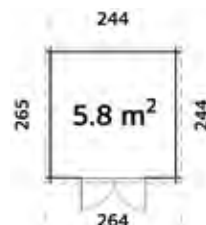

DIMENSIONI

Dimensioni a terra
260 x 260 cm

Dimensioni interne
240 x 240 cm

Altezza parete
194 cm

Altezza totale
208 cm

PORTE

1 porta doppia cm 125 x 162 h,
plexiglass

DOTAZIONI

Pavimento
Optional

Impermeabilizzazione
Cartonfeltro bitumato

SERVIZI

Scarico con sponda idraulica
 Non disponibile

Dropshipping
 Disponibile, vedi condizioni a pag. 132

IMBALLO

Dimensione
cm 320 x 118 x 38 h

Peso lordo
370 kg

OPTIONAL CONSIGLIATI

Pavimento: art. nr. 121459
Guaina ardesiata: nr. 1 rotolo
Kit grondaia "C"
Impregnante: nr. 2 confezioni

Olivia 1 280 x 184 | mm 19

Articolo numero
119223

Materiale
Abete non trattato

In pronta consegna 



STRUTTURA

Tipologia costruttiva
Perline ad incastro

Spessore pareti
19 mm

Perline del tetto
16 mm

DIMENSIONI

Dimensioni a terra
280 x 184 cm

Dimensioni interne
276 x 180 cm

Altezza parete
205 cm

Altezza totale
213 cm

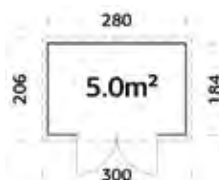

PORTE

1 porta doppia cm 159 x 178 h,
vetro singolo 4 mm

DOTAZIONI

Pavimento
Optional

Impermeabilizzazione
Cartonfeltro bitumato

SERVIZI

Scarico con sponda idraulica
 Non Disponibile

Dropshipping
 Disponibile, vedi condizioni a pag. 132

IMBALLO

Dimensione
cm 320 x 118 x 43 h

Peso lordo
360 kg

OPTIONAL CONSIGLIATI

Pavimento: art. nr. 120507
Guaina ardesiata: nr. 1 rotolo
Kit grondaia "A"
Impregnante: nr. 2 confezioni

Latina 320 x 205 | mm 19

Articolo numero
101933

Materiale
Abete non trattato

In pronta consegna 



STRUTTURA

Tipologia costruttiva
Blockhouse

Spessore pareti
19 mm

Perline del tetto
16 mm

DIMENSIONI

Dimensioni a terra
320 x 205 cm

Dimensioni interne
300 x 185 cm

Altezza parete
177 cm

Altezza totale
217 cm

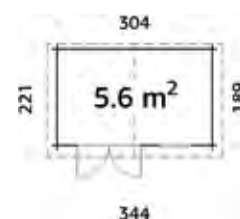

PORTE e FINESTRE

Porte
1 porta doppia cm 125 x 162 h,
plexiglass

Finestre
1 finestra singola cm 64 x 54 h,
plexiglass

DOTAZIONI

Pavimento
Optional

Impermeabilizzazione
Cartonfeltro bitumato

SERVIZI

Scarico con sponda idraulica
 Non disponibile

Dropshipping
 Disponibile, vedi condizioni a pag. 132

IMBALLO

Dimensione
cm 320 x 118 x 40 h

Peso lordo
375 kg

OPTIONAL CONSIGLIATI

Pavimento: art. nr. 102920
Guaina ardesiata: nr. 2 rotoli
Tegole canadesi: nr. 4 confezioni
Kit grondaia "B"
Impregnante: nr. 2 confezioni

Dan A 243 x 190 | mm 16

Articolo numero
101176

Materiale
Abete non trattato

In pronta consegna 



STRUTTURA

Tipologia costruttiva
A pannelli

Spessore pareti
16 mm

Perline del tetto
16 mm

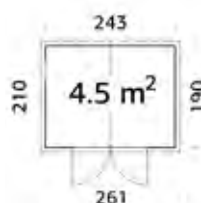

DIMENSIONI

Dimensioni a terra
243 x 190 cm

Dimensioni interne
240 x 187 cm

Altezza parete
190 cm

Altezza totale
220 cm

PORTE e FINESTRE

Porte
1 porta doppia cm 138 x 182 h

Finestre
1 finestra singola cm 44 x 44 h,
plexiglass

DOTAZIONI

Pavimento
16 mm

Impermeabilizzazione
Optional

SERVIZI

Scarico con sponda idraulica
 Disponibile

Dropshipping
 Disponibile, vedi condizioni a pag. 132

IMBALLO

Dimensione
cm 190 x 118 x 55 h

Peso lordo
336 kg

OPTIONAL CONSIGLIATI

Guaina ardesiata: nr. 1 rotolo
Tegole canadesi: nr. 3 confezioni
Kit grondaia "A"
Impregnante: nr. 2 confezioni

Dan B 273 x 280 | mm 16

Articolo numero
101198

Materiale
Abete non trattato

In pronta consegna 



STRUTTURA

Tipologia costruttiva
A pannelli

Spessore pareti
16 mm

Perline del tetto
16 mm

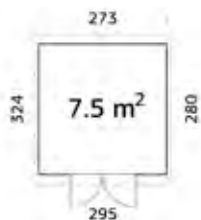

DIMENSIONI

Dimensioni a terra
273 x 280 cm

Dimensioni interne
270 x 277 cm

Altezza parete
190 cm

Altezza totale
220 cm

PORTE e FINESTRE

Porte
1 porta doppia cm 138 x 182 h

Finestre
2 finestre singole cm 44 x 44 h,
plexiglass

DOTAZIONI

Pavimento
16 mm

Impermeabilizzazione
Optional

SERVIZI

Scarico con sponda idraulica
 Disponibile

Dropshipping
 Disponibile, vedi condizioni a pag. 132

IMBALLO

Dimensione
cm 190 x 118 x 69 h

Peso lordo
446 kg

OPTIONAL CONSIGLIATI

Guaina ardesiata: nr. 2 rotolo
Tegole canadesi: nr. 4 confezioni
Kit grondaia "D"
Impregnante: nr. 3 confezioni

Dan C 273 x 370 | mm 16

Articolo numero
101206

Materiale
Abete non trattato

In pronta consegna 

STRUTTURA

Tipologia costruttiva
A pannelli

Spessore pareti
16 mm

Perline del tetto
16 mm



DIMENSIONI

Dimensioni a terra
273 x 370 cm

Dimensioni interne
270 x 367 cm

Altezza parete
190 cm

Altezza totale
220 cm

PORTE e FINESTRE

Porte

1 porta doppia cm 138 x 182 h
1 porta singola cm 75 x 169 h

Finestre

2 finestre singole cm 44 x 44 h,
plexiglass

DOTAZIONI

Pavimento
16 mm

Impermeabilizzazione
Optional

SERVIZI

Scarico con sponda idraulica

✔ Disponibile

Dropshipping

✔ Disponibile, vedi condizioni a pag. 132

IMBALLO

Dimensione
cm 190 x 120 x 90 h

Peso lordo
540 kg

OPTIONAL CONSIGLIATI

Guaina ardesiata: nr. 2 rotoli
Tegole canadesi: nr. 5 confezioni
Kit grondaia "F"
Impregnante: nr. 3 confezioni

Dan D 273 x 550 | mm 16

Articolo numero
101210

Materiale
Abete non trattato

In pronta consegna 

STRUTTURA

Tipologia costruttiva
A pannelli

Spessore pareti
16 mm

Perline del tetto
16 mm

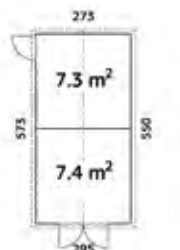

DIMENSIONI

Dimensioni a terra
273 x 550 cm

Dimensioni interne
270 x 547 cm

Altezza parete
190 cm

Altezza totale
230 cm

PORTE e FINESTRE

Porte

1 porta doppia cm 138 x 182 h
1 porta singola cm 75 x 169 h

Finestre

2 finestre singole cm 44 x 44 h,
plexiglass

DOTAZIONI

Pavimento
16 mm

Impermeabilizzazione
Optional

SERVIZI

Scarico con sponda idraulica

✔ Disponibile

Dropshipping

✔ Disponibile, vedi condizioni a pag. 132

IMBALLO

Dimensione
cm 190 x 120 x 110 h

Peso lordo
716 kg

OPTIONAL CONSIGLIATI

Guaina ardesiata: nr. 3 rotoli
Tegole canadesi: nr. 7 confezioni
Kit grondaia "G"
Impregnante: nr. 4 confezioni

Stella A 273 x 190 | mm 16

Articolo numero
101137

Materiale
Abete non trattato

In pronta consegna 



STRUTTURA

Tipologia costruttiva
A pannelli

Spessore pareti
16 mm

Perline del tetto
16 mm

DIMENSIONI

Dimensioni a terra
273 x 190 cm

Dimensioni interne
270 x 187 cm

Altezza parete
189 cm

Altezza totale
229 cm

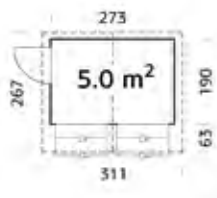

PORTE e FINESTRE

Porte
1 porta singola cm 80 x 173 h

Finestre
2 ante a ribalta cm 119 x 86 h

DOTAZIONI

Pavimento
Optional

Impermeabilizzazione
Optional

SERVIZI

Scarico con sponda idraulica
 Non disponibile

Dropshipping
 Disponibile, vedi condizioni a pag. 132

IMBALLO

Dimensione
cm 320 x 100 x 61 h

Peso lordo
360 kg

OPTIONAL CONSIGLIATI

Pavimento: art. nr. 102883
Guaina ardesiata: nr. 2 rotoli
Tegole canadesi: nr. 4 confezioni
Kit grondaia "C"
Impregnante: nr. 2 confezioni

Stella B 323 x 259 | mm 16

Articolo numero
101141

Materiale
Abete non trattato

In pronta consegna 



STRUTTURA

Tipologia costruttiva
A pannelli

Spessore pareti
16 mm

Perline del tetto
16 mm

DIMENSIONI

Dimensioni a terra
323 x 259 cm

Dimensioni interne
320 x 256 cm

Altezza parete
189 cm

Altezza totale
239 cm



PORTE e FINESTRE

Porte
1 porta singola cm 80 x 173 h

Finestre
2 ante a ribalta cm 119 x 86 h

DOTAZIONI

Pavimento
Optional

Impermeabilizzazione
Optional

SERVIZI

Scarico con sponda idraulica
 Non disponibile

Dropshipping
 Disponibile, vedi condizioni a pag. 132

IMBALLO

Dimensione
cm 400 x 100 x 78 h

Peso lordo
440 kg

OPTIONAL CONSIGLIATI

Pavimento: art. nr. 102924
Guaina ardesiata: nr. 2 rotoli
Tegole canadesi: nr. 5 confezioni
Kit grondaia "D"
Impregnante: nr. 3 confezioni

Marian pieghevole 298 x 228 | mm 16

Articolo numero
112153

Materiale
Abete non trattato

In pronta consegna 



STRUTTURA

Tipologia costruttiva
A pannelli

Spessore pareti
16 mm

Perline del tetto
16 mm

DIMENSIONI

Dimensioni a terra
298 x 228 cm

Dimensioni interne
295 x 225 cm

Altezza parete
207 cm

Altezza totale
245 cm

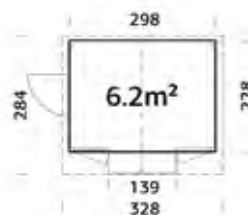

PORTE e FINESTRE

Porte
1 porta singola cm 80 x 173 h

Finestre
1 anta a ribalta cm 139 x 82 h
2 ante cm 65 x 82 h

DOTAZIONI

Pavimento
19 mm

Impermeabilizzazione
Telo in pvc



SERVIZI

Scarico con sponda idraulica
 Non disponibile

Dropshipping
 Disponibile, vedi condizioni a pag. 132

IMBALLO

Dimensione
cm 320 x 120 x 70 h

Peso lordo
650 kg

OPTIONAL CONSIGLIATI

Impregnante: nr. 2 confezioni

Petteri 138 x 158 | mm 28

Articolo numero
111773

Materiale
Abete non trattato

In pronta consegna 



STRUTTURA

Tipologia costruttiva
Blockhouse

Spessore pareti
28 mm

Perline del tetto
19 mm

DIMENSIONI

Dimensioni a terra
138 x 158 cm

Dimensioni interne
114 x 134 cm

Altezza parete
222 cm

Altezza totale
263 cm

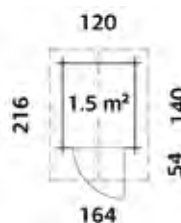

PORTE

1 porta singola cm 84 x 178 h,
vetro singolo 4 mm

DOTAZIONI

Pavimento
16 mm

Impermeabilizzazione
Cartonfeltro bitumato

SERVIZI

Scarico con sponda idraulica
 Disponibile

Dropshipping
 Disponibile, vedi condizioni a pag. 132

IMBALLO

Dimensione
cm 220 x 120 x 49 h

Peso lordo
300 kg

OPTIONAL CONSIGLIATI

Guaina ardesiata: nr. 1 rotolo
Tegole canadesi: nr. 2 confezioni
Impregnante: nr. 2 confezioni

CASSETTE PER BAMBINI

03



Felix 180 x 112 | mm 16

Articolo numero
101125

Materiale
Abete non trattato

In pronta consegna 



STRUTTURA

Tipologia costruttiva
A pannelli

Spessore pareti
16 mm

Perline del tetto
16 mm

DIMENSIONI

Dimensioni a terra
180 x 112 cm

Dimensioni interne
177 x 109 cm

Altezza parete
117 cm

Altezza totale
168 cm

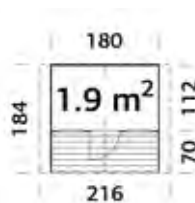

PORTE e FINESTRE

Porte
1 porta singola cm 51 x 112 h

Finestre
2 finestre singole cm 56 x 56 h,
plexiglass

DOTAZIONI

Pavimento
16 mm

Impermeabilizzazione
Optional

SERVIZI

Scarico con sponda idraulica
 Disponibile

Dropshipping
 Disponibile, vedi condizioni a pag. 132

IMBALLO

Dimensione
cm 190 x 118 x 42 h

Peso lordo
176 kg

OPTIONAL CONSIGLIATI

Guaina ardesiata: nr. 1 rotolo
Tegole canadesi: nr. 2 confezioni
Impregnante: nr. 1 confezione

Toby 180 x 192 | mm 16

Articolo numero
101129

Materiale
Abete non trattato

In pronta consegna 



STRUTTURA

Tipologia costruttiva
A pannelli

Spessore pareti
16 mm

Perline del tetto
16 mm

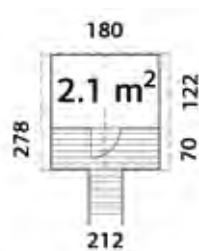

DOTAZIONI

Pavimento
16 mm

DIMENSIONI

Dimensioni a terra
180 x 192 cm

Dimensioni interne
177 x 119 cm

Altezza parete
117 cm

Altezza totale
169 - 287 cm

Altezza palafitta da terra
118,5 cm

PORTE e FINESTRE

Porte
1 porta singola cm 51 x 115 h

Finestre
2 finestre singole cm 35 x 35 h,
plexiglass

Impermeabilizzazione
Optional

SERVIZI

Scarico con sponda idraulica
 Disponibile

Dropshipping
 Disponibile, vedi condizioni a pag. 132

IMBALLO

Dimensione
cm 190 x 120 x 50 h

Peso lordo
260 kg

OPTIONAL CONSIGLIATI

Guaina ardesiata: nr. 1 rotolo
Tegole canadesi: nr. 2 confezioni
Impregnante: nr. 1 confezione

Tom 220 x 180 | mm 16

Articolo numero
101091

Materiale
Abete non trattato

In pronta consegna 



STRUTTURA

Tipologia costruttiva
A pannelli

Spessore pareti
16 mm

Perline del tetto
16 mm

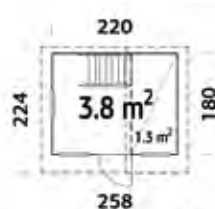

DOTAZIONI

Pavimento
16 mm

Soppalco interno

DIMENSIONI

Dimensioni a terra
220 x 180 cm

Dimensioni interne
217 x 177 cm

Altezza parete
116 cm

Altezza totale
224 cm

PORTE e FINESTRE

Porte
1 porta singola cm 51 x 115 h

Finestre
4 finestre singole cm 35 x 35 h,
plexiglass

Impermeabilizzazione
Optional

SERVIZI

Scarico con sponda idraulica
 Disponibile

Dropshipping
 Disponibile, vedi condizioni a pag. 132

IMBALLO

Dimensione
cm 220 x 120 x 50 h

Peso lordo
290 kg

OPTIONAL CONSIGLIATI

Guaina ardesiata: nr. 1 rotolo
Tegole canadesi: nr. 3 confezioni
Impregnante: nr. 2 confezioni

Otto 233 x 157 | mm 16

Articolo numero
101249

Materiale
Abete non trattato

In pronta consegna 



STRUTTURA

Tipologia costruttiva
A pannelli

Spessore pareti
16 mm

Perline del tetto
16 mm



DIMENSIONI

Dimensioni a terra
233 x 157 cm

Dimensioni interne
230 x 154 cm

Altezza parete
146 cm

Altezza totale
220 cm

PORTE e FINESTRE

Porte
1 porta singola cm 51 x 112 h

Finestre
2 finestre singole cm 56 x 56 h,
plexiglass

DOTAZIONI

Pavimento
16 mm

Impermeabilizzazione
Optional

SERVIZI

Scarico con sponda idraulica
 Disponibile

Dropshipping
 Disponibile, vedi condizioni a pag. 132

IMBALLO

Dimensione
cm 230 x 118 x 52 h

Peso lordo
357 kg

OPTIONAL CONSIGLIATI

Guaina ardesiata: nr. 1 rotolo
Tegole canadesi: nr. 3 confezioni
Impregnante: nr. 1 confezione

Anny 113 x 97 | mm 10

Articolo
KO/CASANNY

Materiale
Legno colorato rosso

In pronta consegna 



STRUTTURA

Tipologia costruttiva
A pannelli

Spessore pareti
10 mm

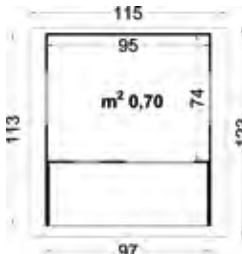

DIMENSIONI

Dimensioni a terra
113 x 97 cm

Dimensioni interne
95 x 74 cm

Altezza parete
82 cm

Altezza totale
150 cm

DOTAZIONI

Pavimento
10 mm

SERVIZI

Scarico con sponda idraulica
 Disponibile

Dropshipping
 Disponibile, vedi condizioni a pag. 132

IMBALLO

Dimensione
cm 142 x 110 x 25 h

Peso lordo
40 kg

Joy 163 x 146 | mm 19

Articolo
TI/CASJOY

Materiale
Abete non trattato

In pronta consegna 



STRUTTURA

Tipologia costruttiva
Blockhouse

Spessore pareti
19 mm

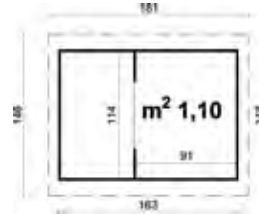

DOTAZIONI

Pavimento
16 mm

DIMENSIONI

Dimensioni a terra
163 x 146 cm

Dimensioni interne
114 x 91 cm

Altezza parete
232 cm

Altezza totale
265 cm

Altezza palafitta da terra
119 cm

PORTE e FINESTRE

Porte
1 porta singola cm 61 x 103 h

Finestre
1 finestra singola cm 47 x 50 h,
plexiglass

SERVIZI

Scarico con sponda idraulica
 Disponibile

Dropshipping
 Disponibile, vedi condizioni a pag. 132

IMBALLO

Dimensione
cm 178 x 80 x 38 h

Peso lordo
161 kg

OPTIONAL CONSIGLIATI

Guaina ardesiata: nr. 1 rotolo
Impregnante: nr. 1 confezione

Sabbiera Smart

Articolo
EK/SABBIERASMART

Materiale
Pino impregnato a pressione

In pronta consegna 



STRUTTURA

Spessore tavole
18 mm

DIMENSIONI

Profondità
112 cm

Lunghezza
112 cm

SERVIZI

Scarico con sponda idraulica
 Disponibile

Dropshipping
 Disponibile, vedi condizioni a pag. 132

IMBALLO

Dimensione
cm 60 x 40 x 20 h

Peso lordo
70 kg

Kicca 1

Articolo
WE/KICCA

Materiale
Pino impregnato a pressione

In pronta consegna 



STRUTTURA

Il set comprende

- 1 torretta di avvistamento completa di scaletta e arrampicata
- 1 scivolo

Note

Fornito in kit di montaggio

Gioco conforme EN 071
uso privato 4-10 anni

DIMENSIONI

Dimensioni torretta
cm 110 x 130 x 270 h

Ingombro totale con scivolo
cm 110 x 280 x 270 h

Altezza piattaforma da terra
120 cm

SERVIZI

Scarico con sponda idraulica

 Disponibile

Dropshipping

 Disponibile, vedi condizioni a pag. 132

IMBALLO

Dimensione
cm 230 x 50 x 60 h

Peso lordo
75 kg

Kicca 2

Articolo
WE/KICCA2

Materiale
Pino impregnato a pressione

In pronta consegna 



STRUTTURA

Il set comprende

- 1 torretta di avvistamento completa di scaletta e arrampicata
- 1 scivolo
- 1 altalena doppia con seggiolini liberi

Note

Fornito in kit di montaggio

Gioco conforme EN 071
uso privato 4-10 anni

DIMENSIONI

Dimensioni torretta
cm 110 x 130 x 270 h

Ingombro totale con scivolo e altalena
cm 300 x 280 x 270 h

Altezza piattaforma da terra
120 cm

SERVIZI

Scarico con sponda idraulica

 Disponibile

Dropshipping

 Disponibile, vedi condizioni a pag. 132

IMBALLO

Dimensione
cm 230 x 50 x 80 h

Peso lordo
105 kg

Babby

Articolo
EX/ALTSING



Materiale

Pino impregnato a pressione

In pronta consegna



STRUTTURA

Il set comprende

- 1 altalena singola con seduta in plastica
- Montanti dimensioni 7 x 7 cm
- Traversa altalena dimensioni 9 x 9 cm

Note

Fornito in kit di montaggio

*Gioco conforme EN 071
uso privato*

DIMENSIONI

Dimensioni totali
230 x 160 x 195 cm

SERVIZI

Scarico con sponda idraulica

Disponibile

Dropshipping

Disponibile, vedi condizioni a pag. 132

IMBALLO

Dimensione
cm 230 x 83 x 30 h

Peso lordo
40 kg

Mিনny

Articolo
103645



Materiale

Pino impregnato a pressione

In pronta consegna



STRUTTURA

Il set comprende

- 1 altalena doppia con sedute in plastica
- Montanti diametro 8 cm
- Traversa altalena diametro 10 cm

Note

Fornito in kit di montaggio

*Gioco conforme EN 071
uso privato*

DIMENSIONI

Dimensioni totali
194 x 310 x 230 cm

SERVIZI

Scarico con sponda idraulica

Non disponibile

Dropshipping

Disponibile, vedi condizioni a pag. 132

IMBALLO

Dimensione
cm 300 x 30 x 30 h

Peso lordo
66 kg

Seggiolino avvolgente

Articolo
TB/SEGAUV



Descrizione

Seggiolino in plastica rossa
Corda in polipropilene

Dimensioni

52 x 36 x 29 cm

Note

Senza collari

CARPORT



Karl Carport singolo

Articolo numero
101021

Materiale
Abete grezzo non trattato

In pronta consegna 



STRUTTURA E DIMENSIONI

Montanti
In abete lamellare, 12 x 12 cm

Banchine laterali
12 x 4,5 cm

Arcarecci
6 x 16 cm

Perline del tetto
19 mm

DOTAZIONI

Impermeabilizzazione
Optional

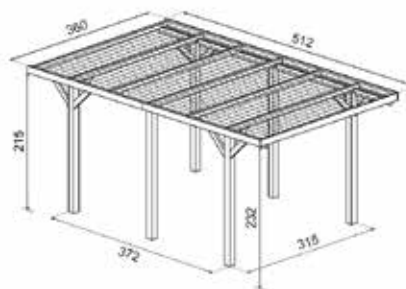

SERVIZI

Scarico con sponda idraulica

 Non disponibile

Dropshipping

 Disponibile, vedi condizioni a pag. 132

IMBALLO

Dimensione
cm 600 x 118 x 32 h

Peso lordo
645 kg

OPTIONAL CONSIGLIATI

Staffe per il fissaggio a terra: nr. 6
Guaina ardesiata: nr. 6 rotoli
Guaina EPDM: nr. 2 rotoli
Impregnante: nr. 4 confezioni

Karl Carport doppio

Articolo numero
101033

Materiale
Abete grezzo non trattato

In pronta consegna 



STRUTTURA E DIMENSIONI

Montanti
In abete lamellare, 12 x 12 cm

Banchine laterali
19,5 x 7,50 cm

Arcarecci
6 x 16 cm

Perline del tetto
19 mm

DOTAZIONI

Impermeabilizzazione
Optional

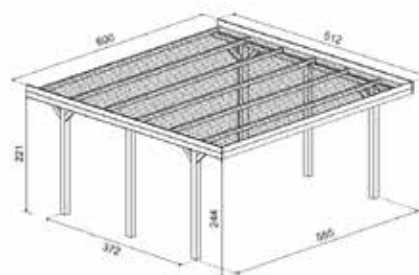

SERVIZI

Scarico con sponda idraulica

 Non disponibile

Dropshipping

 Disponibile, vedi condizioni a pag. 132

IMBALLO

Dimensione
cm 600 x 118 x 45 h

Peso lordo
1005 kg

OPTIONAL CONSIGLIATI

Staffe per il fissaggio a terra: nr. 6
Guaina ardesiata: nr. 7 rotoli
Guaina EPDM: nr. 3 rotoli
Impregnante: nr. 4 confezioni

RELAX IN GIARDINO

05



Delia

Articolo
EK/PANDE

Materiale
Pino impregnato a pressione

In pronta consegna 



DIMENSIONI

Spessore telaio
42 mm

Dimensioni totali
175 x 63 x 97 cm

SERVIZI

Scarico con sponda idraulica

 Disponibile

Dropshipping

 Disponibile, vedi condizioni a pag. 132

IMBALLO

Dimensione
cm 177 x 63 x 13 h

Peso lordo
40 kg

Picnic Oasi

Articolo
EK/PICNICOASI

In pronta consegna 

 **Materiale**
Pino impregnato a pressione color marrone



DIMENSIONI

Spessore tavole
42 mm

Dimensione tavolo
177 x 70 cm

Dimensione panche
177 x 23 cm

Dimensioni totali
177 x 154 x 74 cm

Picnic Oasi Inclusive

Articolo
EK/INCLUSIVE

La versione "inclusive", che mantiene inalterate le caratteristiche della versione standard, consente un facile e sicuro accesso alle carrozzine per disabili.

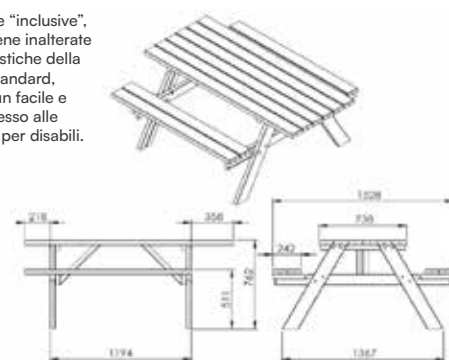

SERVIZI

Scarico con sponda idraulica

 Disponibile

Dropshipping

 Disponibile, vedi condizioni a pag. 132

IMBALLO

Dimensione
cm 180 x 80 x 11 h

Peso lordo
76 kg

Ercole

Articoli
Tavolo EK/TAVERCOLE
Panca EK/PANERCOLE

In pronta consegna 

 **Materiale**
Pino impregnato a pressione



TAVOLO

Spessore tavole
44 mm

Dimensioni
240 x 90 x 82 cm

PANCA

Spessore tavole
42 mm

Dimensioni
200 x 65 x 92 cm

SERVIZI

Scarico con sponda idraulica

 Disponibile

Dropshipping

 Disponibile, vedi condizioni a pag. 132

IMBALLO TAVOLO

Dimensione
cm 240 x 99 x 13 h

Peso lordo
100 kg

IMBALLO PANCA

Dimensione
cm 200 x 65 x 23 h

Peso lordo
63 kg

Set Rodi

Articolo
LO/RODI



Materiale

Legno di carpino verniciato a base acqua

In pronta consegna



STRUTTURA

Il set comprende

- 1 tavolo pieghevole
- 4 sedie pieghevoli

DIMENSIONI TAVOLO

Piano

135 x 75 cm

Altezza

74 cm

DIMENSIONI SEDIA

Larghezza seduta

43 cm

Profondità

39 cm

Altezza seduta sedia

46 cm

Altezza totale sedia

89 cm

Area di seduta di 4 persone

240 x 135 cm

SERVIZI

Scarico con sponda idraulica

Disponibile

Dropshipping

Disponibile, vedi condizioni a pag. 132

IMBALLO

Dimensione

cm 136 x 100 x 30 h

Peso lordo

46 kg

Bistrot Cannes

Articolo
LO/CANNES



Materiale

Legno di carpino verniciato a base acqua

In pronta consegna



STRUTTURA

Il set comprende

- 1 tavolo pieghevole
- 2 sedie pieghevoli
- 2 cuscini

DIMENSIONI TAVOLO

Piano

60 x 60 cm

Altezza

72 cm

DIMENSIONI SEDIA

Larghezza seduta

40 cm

Profondità

30 cm

Altezza seduta sedia

41 cm

Altezza totale sedia

76 cm

SERVIZI

Scarico con sponda idraulica

Disponibile

Dropshipping

Disponibile, vedi condizioni a pag. 132

IMBALLO

Dimensione

cm 100 x 62 x 30 h

Peso lordo

19 kg

LINEA EASYLINE

06



Margherita

Articolo
EX/FIOGRI 13540



Materiale

Pino massello impregnato a pressione

In pronta consegna 



DIMENSIONI

Spessore pareti fioriera
3 cm

Altezza fioriera
35 cm

Altezza grigliato
100 cm

Luce foro
6,5 x 6,5 cm

Dimensioni totali
80 x 40 x 135 cm

Note

Fornito in kit di montaggio

DOTAZIONI

Tessuto non tessuto

IMBALLO

Dimensione
cm 135 x 80 x 10 h

Peso lordo
10 kg

BANCALE

12 pezzi

MINIMO D'ORDINE

2 pezzi

Orto Apple Medium

Articolo
EK/ORAM

In pronta consegna 

 **Materiale**
Pino impregnato a pressione color marrone



DIMENSIONI

Dimensione fioriera
120 x 80 x 27 cm

Dimensione totale
120 x 80 x 88 cm

Note
Fornito in kit di montaggio, preforato e completo di telo tessuto non tessuto

IMBALLO

Dimensione
cm 118 x 30 x 27 h

Peso lordo
35 kg

Orto Four

Articolo
EK/ORFOUR

In pronta consegna 

 **Materiale**
Pino impregnato a pressione color marrone



DIMENSIONI

Dimensione totale
90 x 90 x 46 cm

Note
Fornito in kit di montaggio

IMBALLO

Dimensione
cm 100 x 55 x 9 h

Peso lordo
17 kg

Orto Cassettiera

Articolo
EK/CASSORTO

In pronta consegna 

 **Materiale**
Pino impregnato a pressione color marrone



DIMENSIONI

Dimensione totale
50 x 54 x 60 cm

Note
Fornita in kit di montaggio

IMBALLO

Dimensione
cm 60 x 50 x 22 h

Peso lordo
13 kg

Fioriere Rosa

Materiale
Pino grezzo

In pronta consegna 



STRUTTURA

Spessore tavole
19 mm

Componenti metallici
zincati a caldo

Note

- Fornite in kit di montaggio
- Ogni singola fioriera può essere sovrapposta per creare diverse composizioni

| ARTICOLO NUMERO | DIMENSIONE TOTALE |
|-----------------|--------------------|
| UP/RO8012020 | cm 80 x 120 x 20 h |
| UP/RO806020 | cm 80 x 60 x 20 h |
| UP/RO804020 | cm 80 x 40 x 20 h |

Fioriere Lavanda

Materiale
Pino grezzo

In pronta consegna 



STRUTTURA

Spessore tavole
19 mm

Laterale
Metallo verniciato color antracite

Note

Fornite in kit di montaggio

| ARTICOLO NUMERO | DIMENSIONE TOTALE |
|-----------------|--------------------|
| UP/LA363632 | cm 36 x 36 x 32 h |
| UP/LA583632 | cm 58 x 36 x 32 h |
| UP/LA783632 | cm 78 x 36 x 32 h |
| UP/LA1183632 | cm 118 x 36 x 32 h |

Fioriere Primula

Materiale
Pino grezzo

In pronta consegna 



STRUTTURA

Spessore tavole
19 mm

Componenti metallici
zincati a caldo

Note

- Fornite in kit di montaggio
- Completa di rotelle con freno

| ARTICOLO NUMERO | DIMENSIONE TOTALE |
|-----------------|-------------------|
| UP/PRI408028 | cm 40 x 80 x 28 h |

Fioriere Tulipano

Materiale
Pino impregnato a pressione

In pronta consegna 



STRUTTURA

Sezione tavole
3,5 x 6 cm

Componenti metallici
zincati a caldo

Note

- Fornite in kit di montaggio
- Completa di tessuto non tessuto

| ARTICOLO NUMERO | DIMENSIONE TOTALE | BANCALE |
|-----------------|---------------------|----------|
| DP/FIO404040 | cm 40 x 40 x 32,5 h | 45 pezzi |

Fioreria Camelia bianca

Materiale
Abete laccato color bianco

In pronta consegna 



DIMENSIONI

Tavole
1,9 x 4,5 cm

Note

- Fornite in kit di montaggio
- Complete di tessuto non tessuto

ARTICOLO NUMERO

DIMENSIONE

DA/CA404040B
DA/CA505050B

cm 40 x 40 x 40 h
cm 50 x 50 x 50 h

Bordi Roll

Materiale
Pino impregnato a pressione

In pronta consegna 



DIMENSIONI

Mezzi pali
Diametro 5 cm

ARTICOLO NUMERO

DIMENSIONE

BANCALE

MINIMO D'ORDINE

EX/BROLL30200
EX/BROLL40200

cm 200 x 30 h
cm 200 x 40 h

60 pezzi
40 pezzi

10 pezzi
10 pezzi

Bordi Fast

Materiale
Legno impregnato a pressione

In pronta consegna 



| ARTICOLO NUMERO | DIMENSIONE | BANCALE | MINIMO D'ORDINE |
|-----------------|------------------|----------|-----------------|
| AC/BEASY | cm 120 x 30/45 h | 72 pezzi | 20 pezzi |

Bordi Easy

Materiale
Legno impregnato a pressione

In pronta consegna 



| ARTICOLO NUMERO | DIMENSIONE | BANCALE | MINIMO D'ORDINE |
|-----------------|------------------|----------|-----------------|
| AC/BEASY | cm 110 x 30/45 h | 56 pezzi | 15 pezzi |

Frangivista Delux bianco

Materiale
Abete laccato color bianco

In pronta consegna



DIMENSIONI

Profili orizzontali
1,9 x 4,5 cm

Profili verticali
3,5 x 4,5 cm

Note
Staffe per il fissaggio a terra escluse

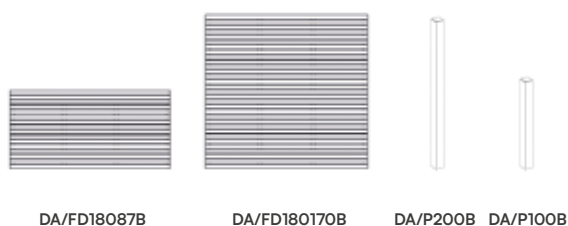

| ARTICOLO NUMERO | PRODOTTO | DIMENSIONE | MINIMO D'ORDINE |
|-----------------|-----------------------|------------------|-----------------|
| DA/FD18087B | Pannello | cm 180 x 87 h | 2 pezzi |
| DA/FD180170B | Pannello | cm 180 x 170 h | 4 pezzi |
| DA/P200B | Pilastro di fissaggio | cm 9 x 9 x 180 h | 2 pezzi |
| DA/P100B | Pilastro di fissaggio | cm 9 x 9 x 100 h | 2 pezzi |

Recinzione e cancellino Selenia bianca

Materiale
Abete laccato color bianco

In pronta consegna



DIMENSIONI

Cornice
4,5 x 9 cm

Tavole
2,2 x 6,8 cm

Note

- Staffe per il fissaggio a terra escluse
- Ferramenta per cancellino esclusa

| ARTICOLO NUMERO | PRODOTTO | DIMENSIONE | MINIMO D'ORDINE |
|-----------------|----------------------------------|------------------|-----------------|
| DA/SE18090B | Pannello | cm 180 x 90 h | 5 pezzi |
| DA/SE10090B | Pannello | cm 100 x 90 h | 2 pezzi |
| DA/P100B | Pilastro di fissaggio recinzione | cm 9 x 9 x 100 h | 2 pezzi |

Recinzione e cancellino Tavoletta

Linea Easyline

Materiale
Pino impregnato a pressione

In pronta consegna 



Steccato

DIMENSIONI

Tavolette
1,5 x 9 cm

Note
Cancellino completo di ferramenta



Cancellino

| ARTICOLO NUMERO | PRODOTTO | DIMENSIONE | BANCALE | MINIMO D'ORDINE |
|-----------------|--------------------------------|------------------|----------|-----------------|
| EX/STCTAV100180 | Steccato | cm 180 x 100 h | 40 pezzi | 10 pezzi |
| EX/CANTAV100100 | Cancellino | cm 100 x 100 h | 10 pezzi | 5 pezzi |
| LO/P150 | Pilastro di fissaggio steccato | cm 7 x 7 x 150 h | | 6 pezzi |

Gazebo richiudibile

Articolo
SH/GZ22563

In pronta consegna 



Struttura in acciaio tubolare diametro 28 mm verniciato a polvere color bianco con componenti sintetiche ad alte prestazioni e gambe regolabili in 4 posizioni in altezza. Resistente a scheggiature, ruggine e corrosione. La **copertura** color verde, realizzata in **poliestere** 150 denari, è trattata con trattamento UV all'interno e all'esterno antinvecchiamento.

DIMENSIONI

Totali
300 x 300 cm

Altezza minima
180 - 200 cm

Altezza massima
280 - 310 cm

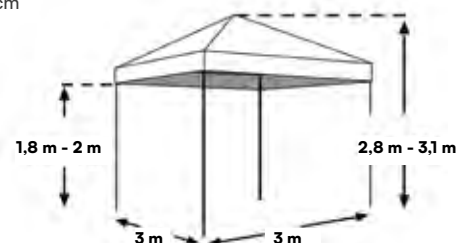

IMBALLO

Dimensione
cm 140 x 26 x 24 h

Peso lordo
28,5 kg

Note
Custodia compresa nel prezzo

Capanni

I nostri capanni sono la soluzione ideale per lo stoccaggio di attrezzature per giardinaggio, piccoli trattori, mobili da giardino, attrezzature per piscina ecc..

- **Telaio** realizzato con tubi in acciaio diametro 35 mm verniciati a polvere color grigio per una migliore protezione da corrosione e ruggine.
- **Interno** color bianco.
- Dotato di chiusura frontale con **cerniera**.
- **Copertura** fissa in tessuto polietilene 213 gr/mq triplo strato "Ripstop" color grigio, trattato UV sia internamente che esternamente anti invecchiamento e anti ingiallimento, cuciture saldate a caldo e impermeabili al 100%, resistente a forature, strappi, ruggine e corrosione.
- **Stabilizzatori brevettati** in ogni connessione per garantire un'elevata resistenza e stabilità.
- Il **sistema di tensione** a cricchetto e cinturino e le guide trasversali mantengono la copertura liscia e tesa.
- Completo di nr. 4 **staffe** lunghezza 38 cm per il fissaggio nel terreno, realizzate in acciaio verniciato a polvere, resistono a scheggiature, ruggine e corrosione.

Capanno 1818

Articolo
SH/CAPANNO1818

In pronta consegna 



DIMENSIONI

Capanno
cm 180 x 180 x 180 h

Apertura porta
150 x 130 cm

IMBALLO

Dimensione
cm 104 x 43 x 14 h

Peso lordo
24,5 kg

Capanno 2424

Articolo
SH/CAPANNO2424

In pronta consegna 



DIMENSIONI

Capanno
cm 246 x 244 x 244 h

Apertura porta
208 x 211 cm

IMBALLO

Dimensione
cm 104 x 51,5 x 14 h

Peso lordo
36 kg

Tavole impregnate per pavimenti

Materiale

Pino impregnato a pressione / impregnazione in classe 3

In pronta consegna 

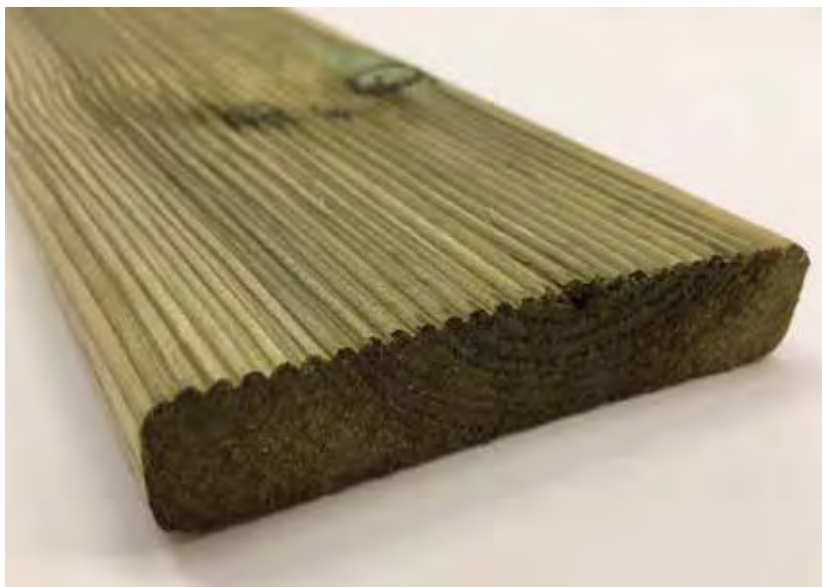

| ARTICOLO NUMERO | DIMENSIONE | BANCALE | MINIMO D'ORDINE |
|-----------------|---------------------|-----------|-----------------|
| LEIMPO20090240 | 1,9 x 9 x 240 cm | 200 pezzi | 40 pezzi |
| LEIMPO20090300 | 1,9 x 9 x 300 cm | 200 pezzi | 40 pezzi |
| LEIMPO30115240 | 2,8 x 11,5 x 240 cm | 100 pezzi | 30 pezzi |
| LEIMPO30115300 | 2,8 x 11,5 x 300 cm | 100 pezzi | 30 pezzi |

Quadrotte Maxi

Materiale

Pino impregnato a pressione

In pronta consegna 



STRUTTURA

Mattonella

Spessore 38 mm

Profili fresati antiscivolo

1,9 x 9,5 cm, 10 pezzi

Traversi di sostegno

1,9 x 9,5 cm, 3 pezzi

| ARTICOLO NUMERO | DIMENSIONE | BANCALE | MINIMO D'ORDINE |
|-----------------|---|----------|-----------------|
| EX/PAVM38100100 | 3,8 x 100 x 100 cm (1 quadrotta = 1 mq) | 22 pezzi | 10 pezzi |

Profili impregnati



Materiale

Pino impregnato a pressione / Impregnazione in classe 3

In pronta consegna 

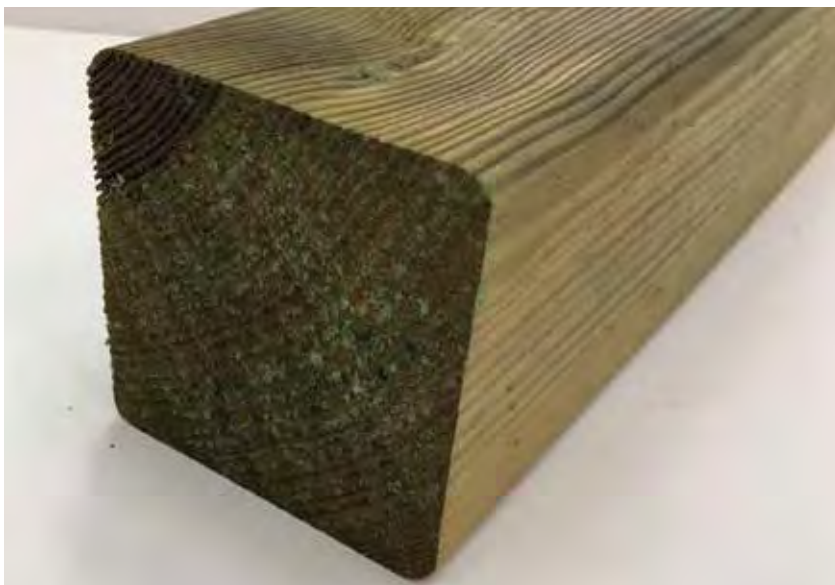

| ARTICOLO NUMERO | DIMENSIONE | BANCALE | MINIMO D'ORDINE |
|-----------------|----------------|----------|-----------------|
| LEIMPO707240 | 7 x 7 x 240 cm | 84 pezzi | 14 pezzi |
| LEIMPO707300 | 7 x 7 x 300 cm | 84 pezzi | 14 pezzi |
| LEIMPO909240 | 9 x 9 x 240 cm | 50 pezzi | 10 pezzi |
| LEIMPO909300 | 9 x 9 x 300 cm | 50 pezzi | 10 pezzi |

Tavole impregnate



Materiale

Pino impregnato a pressione / Impregnazione in classe 3

In pronta consegna 



| ARTICOLO NUMERO | DIMENSIONE | BANCALE | MINIMO D'ORDINE |
|-----------------|---------------------|-----------|-----------------|
| LEIMPO40085240 | 3,8 x 8,5 x 240 cm | 100 pezzi | 10 pezzi |
| LEIMPO40085300 | 3,8 x 8,5 x 300 cm | 100 pezzi | 10 pezzi |
| LEIMPO40116240 | 3,8 x 11,6 x 240 cm | 100 pezzi | 10 pezzi |
| LEIMPO40116300 | 3,8 x 11,6 x 300 cm | 100 pezzi | 10 pezzi |

Pali impregnati con punta

Materiale
Pino impregnato a pressione

In pronta consegna 



| ARTICOLO NUMERO | DIAMETRO | LUNGHEZZA | BANCALE | ACQUISTO A MULTIPLI DI |
|-----------------|----------|-----------|-----------|------------------------|
| PALIO4150PU | 4 cm | 150 cm | 636 pezzi | 20 pezzi |
| PALIO4200PU | 4 cm | 200 cm | 636 pezzi | 20 pezzi |
| PALIO4250PU | 4 cm | 250 cm | 636 pezzi | 20 pezzi |
| PALIO5150PU | 5 cm | 150 cm | 356 pezzi | 20 pezzi |
| PALIO5200PU | 5 cm | 200 cm | 356 pezzi | 20 pezzi |
| PALIO5250PU | 5 cm | 250 cm | 356 pezzi | 20 pezzi |
| PALIO6150PU | 6 cm | 150 cm | 270 pezzi | 20 pezzi |
| PALIO6200PU | 6 cm | 200 cm | 270 pezzi | 20 pezzi |
| PALIO6250PU | 6 cm | 250 cm | 270 pezzi | 20 pezzi |
| PALIO6300PU | 6 cm | 300 cm | 270 pezzi | 20 pezzi |
| PALIO8150PU | 8 cm | 150 cm | 156 pezzi | 10 pezzi |
| PALIO8200PU | 8 cm | 200 cm | 156 pezzi | 10 pezzi |
| PALIO8250PU | 8 cm | 250 cm | 156 pezzi | 10 pezzi |
| PALIO8300PU | 8 cm | 300 cm | 156 pezzi | 10 pezzi |
| PALIO10150PU | 10 cm | 150 cm | 110 pezzi | 10 pezzi |
| PALIO10200PU | 10 cm | 200 cm | 110 pezzi | 10 pezzi |
| PALIO10250PU | 10 cm | 250 cm | 110 pezzi | 10 pezzi |
| PALIO10300PU | 10 cm | 300 cm | 110 pezzi | 10 pezzi |
| PALIO12200PU | 12 cm | 200 cm | 72 pezzi | 10 pezzi |
| PALIO12250PU | 12 cm | 250 cm | 72 pezzi | 10 pezzi |
| PALIO12300PU | 12 cm | 300 cm | 72 pezzi | 10 pezzi |

Pali impregnati

Materiale
Pino impregnato a pressione

In pronta consegna 



| ARTICOLO NUMERO | DIAMETRO | LUNGHEZZA | BANCALE | ACQUISTO A MULTIPLI DI |
|-----------------|----------|-----------|-----------|------------------------|
| PALIO8200 | 8 cm | 200 cm | 156 pezzi | 10 pezzi |
| PALIO8250 | 8 cm | 250 cm | 156 pezzi | 10 pezzi |
| PALIO8300 | 8 cm | 300 cm | 156 pezzi | 10 pezzi |
| PALIO8400 | 8 cm | 400 cm | 156 pezzi | 10 pezzi |
| PALIO10200 | 10 cm | 200 cm | 110 pezzi | 10 pezzi |
| PALIO10250 | 10 cm | 250 cm | 110 pezzi | 10 pezzi |
| PALIO10300 | 10 cm | 300 cm | 110 pezzi | 10 pezzi |
| PALIO10400 | 10 cm | 400 cm | 110 pezzi | 10 pezzi |
| PALIO12150 | 12 cm | 150 cm | 72 pezzi | 10 pezzi |
| PALIO12200 | 12 cm | 200 cm | 72 pezzi | 10 pezzi |
| PALIO12250 | 12 cm | 250 cm | 72 pezzi | 10 pezzi |
| PALIO12300 | 12 cm | 300 cm | 72 pezzi | 10 pezzi |
| PALIO12400 | 12 cm | 400 cm | 72 pezzi | 10 pezzi |

Mezzi pali impregnati

Materiale
Pino impregnato a pressione

In pronta consegna 



| ARTICOLO NUMERO | DIAMETRO | LUNGHEZZA | BANCALE | ACQUISTO A MULTIPLI DI |
|-----------------|----------|-----------|-----------|------------------------|
| MZPALIO8250 | 8 cm | 250 cm | 312 pezzi | 20 pezzi |
| MZPALIO8300 | 8 cm | 300 cm | 312 pezzi | 20 pezzi |
| MZPALIO8400 | 8 cm | 400 cm | 312 pezzi | 20 pezzi |
| MZPALI10250 | 10 cm | 250 cm | 220 pezzi | 20 pezzi |
| MZPALI10300 | 10 cm | 300 cm | 220 pezzi | 20 pezzi |
| MZPALI10400 | 10 cm | 400 cm | 220 pezzi | 20 pezzi |

Pali impregnati - lavorati

Materiale
Pino impregnato a pressione

In pronta consegna 

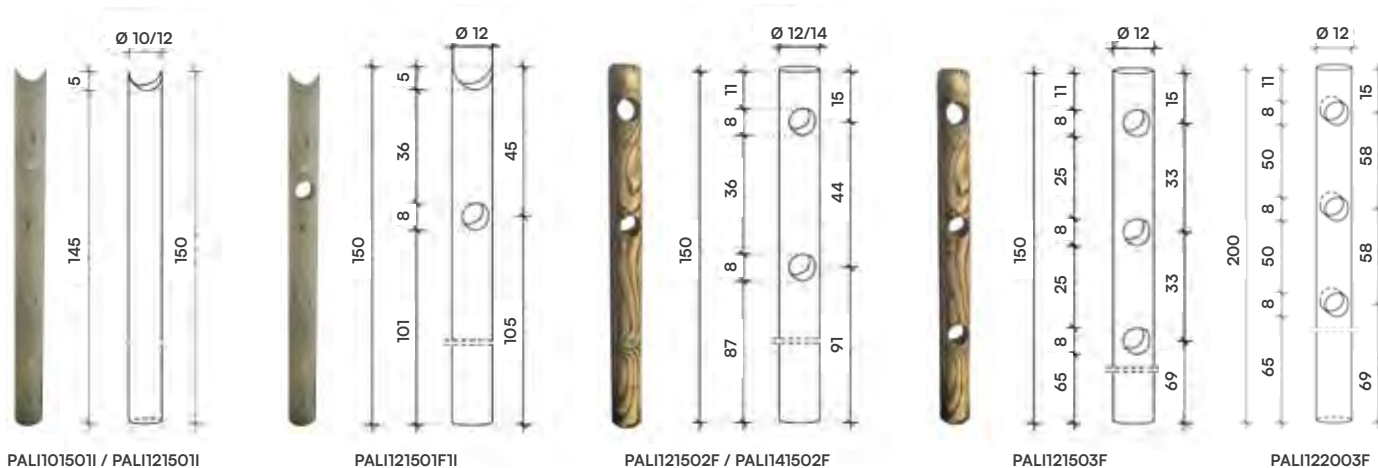

| ARTICOLO NUMERO | LAVORAZIONE | DIAMETRO | LUNGHEZZA | BANCALE | ACQUISTO A MULTIPLI DI |
|-----------------|-------------------------|----------|-----------|-----------|------------------------|
| PALI121501F1I | con un foro e un incavo | 12 cm | 150 cm | 72 pezzi | 10 pezzi |
| PALI121502F | con due fori | 12 cm | 150 cm | 72 pezzi | 10 pezzi |
| PALI141502F | con due fori | 14 cm | 150 cm | 42 pezzi | 10 pezzi |
| PALI101501I | con incavo | 10 cm | 150 cm | 110 pezzi | 10 pezzi |
| PALI121501I | con incavo | 12 cm | 150 cm | 72 pezzi | 10 pezzi |
| PALI121503F | con tre fori | 12 cm | 150 cm | 72 pezzi | 10 pezzi |
| PALI122003F | con tre fori | 12 cm | 200 cm | 72 pezzi | 10 pezzi |



RECINZIONI

07

Recinzione con mezzi pali

Articolo
LO/RECMZPALI

In pronta consegna 

 **Materiale**
Pino impregnato a pressione



DIMENSIONI PILASTRO

Diametro
10 cm

Lunghezza
150 cm

DIMENSIONI TRAVERSA

Diametro
8 cm, mezzi pali

Lunghezza
250 cm

RECINZIONE

Interasse
200 cm

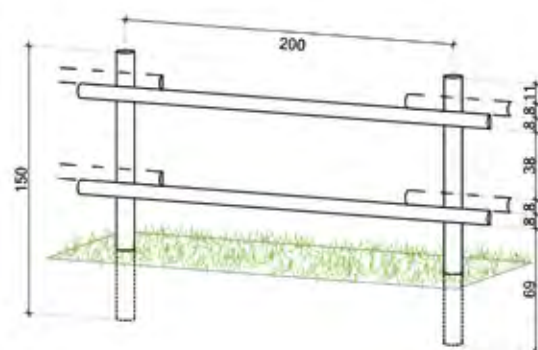

MINIMO D'ORDINE

20 m lineari

Note

- Escluso di viti e staffe per il fissaggio
- Prezzo valido per recinzioni a tratta continua

Recinzione con un foro e un incavo

Articolo
LO/REC1FI1

In pronta consegna 

Materiale
Pino impregnato a pressione



DIMENSIONI PILASTRO

Diametro
12 cm

Lunghezza
150 cm

Diametro foro
8 cm, nr. 1

Diametro incavo
12 cm, nr. 1

DIMENSIONI TRAVERSA

Diametro
8 cm

Lunghezza
200 cm

Diametro corrimano
12 cm

Lunghezza corrimano
200 cm

RECINZIONE

Interasse
200 cm

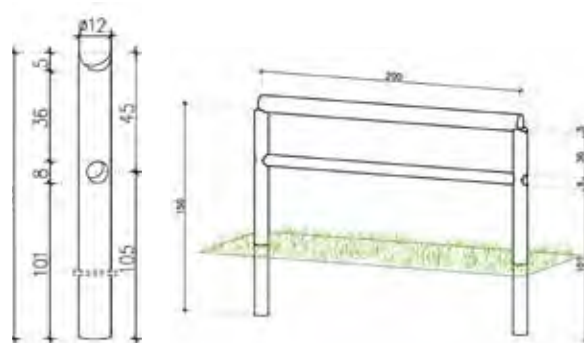

MINIMO D'ORDINE

20 m lineari

Note

- Escluso di viti e staffe per il fissaggio
- Prezzo valido per recinzioni a tratta continua

Recinzione con due fori

Articolo
LO/REC2FORI

In pronta consegna 

Materiale
Pino impregnato a pressione



DIMENSIONI PILASTRO

Diametro
12 cm

Lunghezza
150 cm

Diametro foro
8 cm, nr. 2

DIMENSIONI TRAVERSA

Diametro
8 cm, mezzi pali

Lunghezza
200 cm

RECINZIONE

Interasse
200 cm

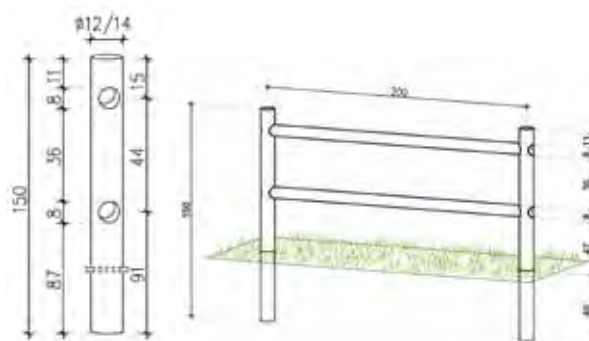

MINIMO D'ORDINE

20 m lineari

Note

- Escluso di viti e staffe per il fissaggio
- Prezzo valido per recinzioni a tratta continua

Recinzione con tre fori

Articolo
LO/REC3FORI

In pronta consegna 

Materiale
Pino impregnato a pressione



DIMENSIONI PILASTRO

Diametro
12 cm

Lunghezza
150 cm

Diametro foro
8 cm, nr. 3

DIMENSIONI TRAVERSA

Diametro
8 cm

Lunghezza
200 cm

RECINZIONE

Interasse
200 cm

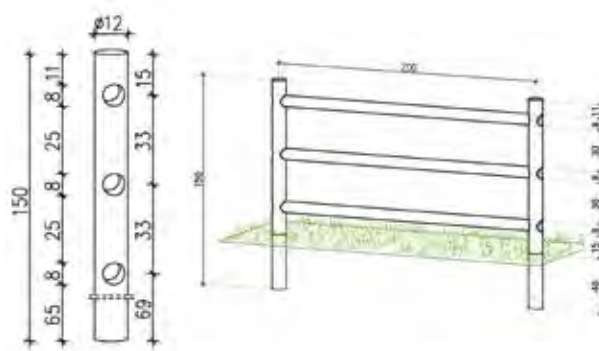

MINIMO D'ORDINE

20 m lineari

Note

- Escluso di viti e staffe per il fissaggio
- Prezzo valido per recinzioni a tratta continua

Recinzione con tre fori 200 h

Articolo
LO/REC3FORI200

In pronta consegna 

Materiale
Pino impregnato a pressione



DIMENSIONI PILASTRO

Diametro
12 cm

Lunghezza
200 cm

Diametro foro
8 cm, nr. 3

DIMENSIONI TRAVERSA

Diametro
8 cm

Lunghezza
200 cm

RECINZIONE

Interasse
200 cm

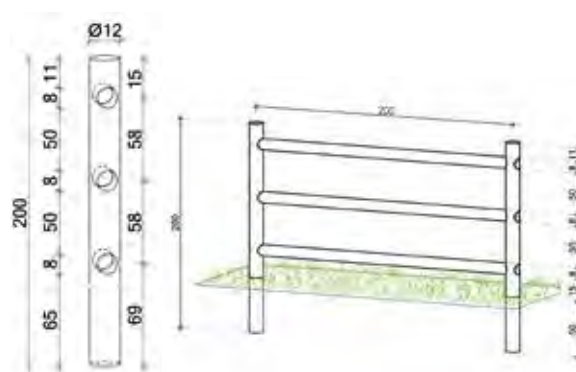

MINIMO D'ORDINE

20 m lineari

Note

- Escluso di viti e staffe per il fissaggio
- Prezzo valido per recinzioni a tratta continua

Recinzione croce di S. Andrea mezzo palo

Articolo
LO/RECCSAMZPALI

In pronta consegna 

Materiale
Pino impregnato a pressione



DIMENSIONI PILASTRO

Diametro
10 cm

Lunghezza
150 cm

Diametro incavo
10 cm, nr. 1

DIMENSIONI TRAVERSA

Diametro
8 cm, mezzi pali

Lunghezza
230 cm

Diametro corrimano
10 cm

Lunghezza corrimano
200 cm

RECINZIONE

Interasse
200 cm

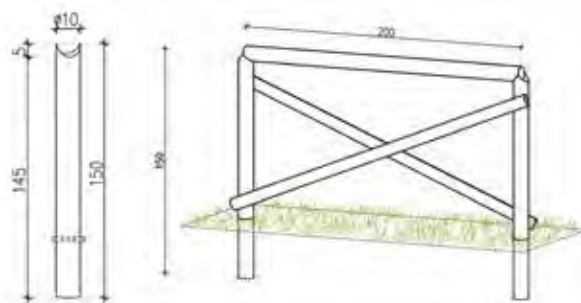

MINIMO D'ORDINE

20 m lineari

Note

- Escluso di viti e staffe per il fissaggio
- Prezzo valido per recinzioni a tratta continua

Recinzione croce di S. Andrea palo pieno

Articolo
LO/RECSANDREA

Su ordinazione 

Materiale
Pino impregnato a pressione



DIMENSIONI PILASTRO

Diametro
10 cm

Lunghezza
150 cm

Diametro incavo
10 cm, nr. 1

DIMENSIONI TRAVERSA

Diametro
8 cm

Lunghezza
230 cm con lavorazione a incastro

Diametro corrimano
10 cm

Lunghezza corrimano
200 cm

RECINZIONE

Interasse
200 cm

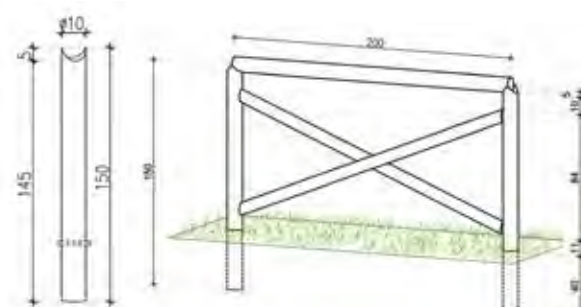

MINIMO D'ORDINE

20 m lineari

Note

- Escluso di viti e staffe per il fissaggio
- Prezzo valido per recinzioni a tratta continua

ACCESSORI



Accessori per cassette

In pronta consegna 

GUAINA ARDESIATA

Guaina bituminosa armatura velovetro con graniglia ceramizzata



Verde

Rossa

| ARTICOLO NUMERO | COLORE | ROTOLO |
|-----------------|--------|--------|
| GUAARDV | Verde | 10 mq |
| GUAARDR | Rossa | 10 mq |

TEGOLE CANADESI

Tegole bituminose armatura poliestere con graniglia ceramizzata

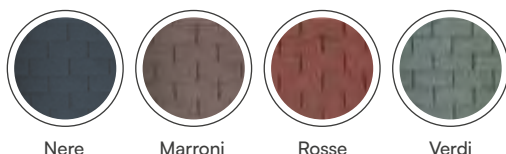

Nere

Marroni

Rosse

Verdi

| ARTICOLO NUMERO | COLORE | CONFEZIONE |
|-----------------|---------|------------|
| 107180 | Nere | 3 mq |
| 107181 | Marroni | 3 mq |
| 107182 | Rosse | 3 mq |
| 107183 | Verdi | 3 mq |

EPDM

Membrana impermeabilizzante realizzata in gomma sintetica



| ARTICOLO NUMERO | COLORE | ROTOLO |
|-----------------|--------|--------|
| 111847 | Nero | 15 mq |

IMPREGNANTE

Impregnante all'acqua

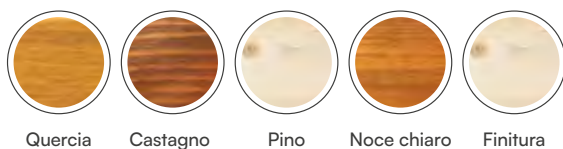

Quercia

Castagno

Pino

Noce chiaro

Finitura cerata incolore

| ARTICOLO NUMERO | COLORE | CONFEZIONE |
|-----------------|--------------------------|------------|
| IMPRCASQ | Quercia | 4 litri |
| IMPRCASC | Castagno | 4 litri |
| IMPRCASP | Pino | 4 litri |
| IMPRCASN | Noce chiaro | 4 litri |
| CERFIN | Finitura cerata incolore | 5 litri |

Grondaie

In pronta consegna 

Le grondaie hanno una funzione molto importante, poiché limitano notevolmente le operazioni di manutenzione periodica. Le grondaie e i loro accessori sono prodotte in robusto metallo galvanizzato e verniciato; sono resistenti, non si deformano e sono durevoli nel tempo.

Complete di:

- Canale di gronda / din 100 in lamiera zincata preverniciata (testa di moro) - bocca 100 mm - sv. 250
- Sostegno / in piatto nervato con linguette di bloccaggio - acciaio verniciato a polvere
- Bocchetta di scarico / modello svizzero per canale di gronda diametro scarico 60 mm - lamiera preverniciata (testa di moro)
- Testata terminale / destra o sinistra din 100 - lamiera preverniciata (testa di moro) - con banda adesiva
- Tubo di discesa / diametro 60 mm in lamiera preverniciata
- Collare fermatubo / diametro 60 mm completo di fissaggio in lamiera preverniciata
- Curva / diametro 60 mm
- Set fissaggi - bande adesive - guanti e istruzioni

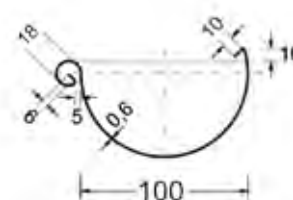

| ARTICOLO NUMERO | KIT | DIMENSIONI |
|-----------------|-----|--|
| ARIKITGR2A | "A" | Per cassette con falde da 180 a 219 cm |
| ARIKITGR2B | "B" | Per cassette con falde da 220 a 259 cm |
| ARIKITGR2C | "C" | Per cassette con falde da 260 a 300 cm |
| ARIKITGR2D | "D" | Per cassette con falde da 301 a 349 cm |
| ARIKITGR2E | "E" | Per cassette con falde da 350 a 390 cm |
| ARIKITGR2F | "F" | Per cassette con falde da 400 a 490 cm |
| ARIKITGR2G | "G" | Per cassette con falde da 500 a 580 cm |

NB: Prodotti non vendibili senza cassette.

COPERCHIETTI PER PALI QUADRI

Zincati a caldo



| ARTICOLO NUMERO | DIMENSIONE |
|-----------------|------------|
| COP0707I | 7 x 7 cm |
| COP0909I | 9 x 9 cm |

COPERCHIETTI PER PALI TONDI

Color rame



| ARTICOLO NUMERO | DIMENSIONE |
|-----------------|------------|
| COPT08RA | 8 cm |
| COPT10RA | 10 cm |
| COPT12RA | 12 cm |

PORTAPILASTRO A BICCHIERE PER PALO QUADRO

Zincato a caldo



| ARTICOLO NUMERO | DIMENSIONE |
|-----------------|---------------------------------|
| STAQ0707 | Staffa alloggio palo 7 x 7 cm |
| STAQ0909 | Staffa alloggio palo 9 x 9 cm |
| STAQ1212 | Staffa alloggio palo 12 x 12 cm |

PORTAPILASTRO A BICCHIERE PER PALO TONDO

Zincato a caldo



| ARTICOLO NUMERO | DIMENSIONE |
|-----------------|-------------------------------------|
| STAT08 | Staffa alloggio palo diametro 8 cm |
| STAT10 | Staffa alloggio palo diametro 10 cm |
| STAT12 | Staffa alloggio palo diametro 12 cm |

PORTAPILASTRO A FICCONE PER PALO QUADRO

Zincato a caldo



| ARTICOLO NUMERO | DIMENSIONE |
|-----------------|-------------------------------|
| STAFQ70 | Staffa alloggio palo 7 x 7 cm |
| STAFQ90 | Staffa alloggio palo 9 x 9 cm |

PORTAPILASTRO A FICCONE PER PALO QUADRO - REGOLABILE

Zincato a caldo



| ARTICOLO NUMERO | DIMENSIONE |
|-----------------|---|
| STAREFQ | Staffa alloggio regolabile da 7 a 12 cm |

PORTAPILASTRO A FICCONE PER PALO TONDO - REGOLABILE

Zincato a caldo



| ARTICOLO NUMERO | DIMENSIONE |
|-----------------|---|
| STAREFT | Staffa alloggio regolabile da 8 a 14 cm |

STAFFA A "U" PER FISSAGGIO CORRIMANO

Zincato a caldo



| ARTICOLO NUMERO | DIMENSIONE |
|-----------------|--------------------------------------|
| STAU10 | Collare per corrimano diametro 10 cm |
| STAU12 | Collare per corrimano diametro 12 cm |

Telai di base

Su ordinazione 

Offriamo ai nostri clienti un **Foundation Kit**, che comprende un telaio di fondazione tagliato su misura e **pieдини metallici regolabili**, conosciuti come **LogFoot™**.
I telai di fondazione sono pre-tagliati in alcune misure standard. Tuttavia, per garantire un adattamento perfetto alla tua casetta da giardino, sono necessarie alcune regolazioni finali per adeguare il telaio alle dimensioni esatte della struttura.

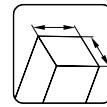

45 x 70 mm

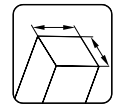

44 x 120 mm



Trattamento

Impregnato ad immersione color marrone



Articolo nr. 119295
300 x 300 cm



Articolo nr. 119297
450 x 300 cm



Articolo nr. 119299
600 x 300 cm



Articolo nr. 119293
600 x 600 cm



Articolo nr. 119301
450 x 450 cm



Articolo nr. 119303
600 x 450 cm



Articolo nr. 119355
240 x 180 cm



Articolo nr. 119372
270 x 230 cm



STAFFE LOGFOOT™
Staffa angolare e per telaio



Scansiona questo codice QR per vedere il montaggio di un telaio di base.





Maggiori
informazioni

09

CASETTE CON SERRAMENTI IN ALLUMINIO



Vedi colorazioni disponibili a pag. 133

Doppio vetro

VETRO A BASSA EMISSIVITÀ (LOW ENERGY GLASS)

Il vetro a bassa emissività differisce dal vetro comune perché è dotato di uno speciale rivestimento metallico, chiamato **rivestimento a bassa emissività (Low-E)**.

Il vetro a risparmio energetico è un tipo di vetro isolante che aumenta l'efficienza energetica riducendo il trasferimento di calore o di freddo attraverso la superficie vetrata.

- **Vetro temperato multistrato isolante da 24 mm**
 - . 4 mm vetro di sicurezza temperato
 - . Intercapedine da 16 mm riempita con gas argon
 - . 4 mm vetro di sicurezza temperato
- **Valore U del vetro: 1,0**
- **Abbattimento acustico fino a 35 dB**

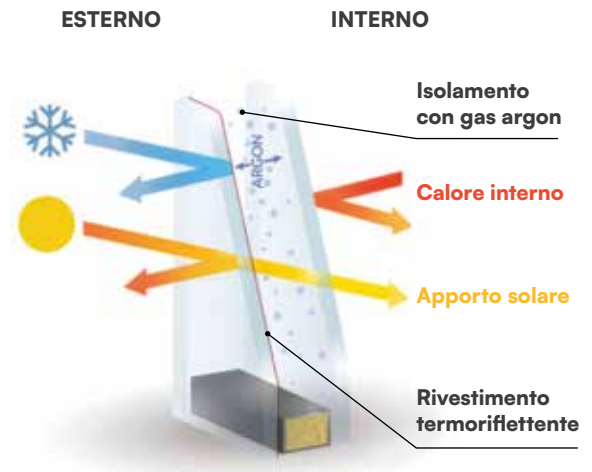

PROFILI IN ALLUMINIO

- Porte apribili e scorrevoli **verso entrambi i lati**
- Profili robusti per garantire **stabilità e durata anche in presenza di forti venti**
- Sistema di binari ad alte prestazioni con **cuscinetti a sfere rinforzati in nylon e binari in alluminio anodizzato** inseriti nelle guide, per uno scorrimento più fluido delle ante
 - **Binario inferiore auto-drenante** con canale di scarico nascosto che impedisce l'ingresso dell'acqua
 - **Guarnizioni in tutti gli angoli**
 - **Staffe angolari interne rinforzate** per connessioni del telaio estremamente solide
 - **Guarnizioni, spazzole e profili preforati già assemblati per semplificare l'installazione**
 - **Gocciolatoio** installato su tutta la lunghezza (nel sistema scorrevole)
 - **Colore:** grigio antracite RAL 7016 / valore di lucentezza 30% opaco

PORTE

- **Sistema di interblocco** con blocco antivento e doppie spazzole per una tenuta completamente ermetica
- **Doppie guarnizioni** attorno al vetro nel telaio in alluminio
- **Guarnizioni a spazzola** nei binari superiori e inferiori che sigillano lo spazio tra le ante
- **Ammortizzatori con funzione antivento** tra ogni porta per un'apertura e chiusura morbida e confortevole
- **Tappi di sicurezza** che impediscono il sollevamento delle porte
- **Maniglia ergonomica esterna e serratura a cilindro** sul lato esterno della porta di passaggio
- **Due chiusure interne**, una per ciascun lato



Lisandra 14,2 m²



Su ordinazione

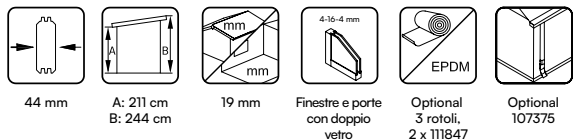
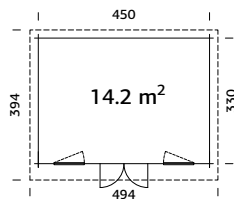

Lisandra 19,4 m²



Su ordinazione

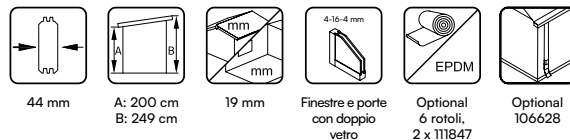
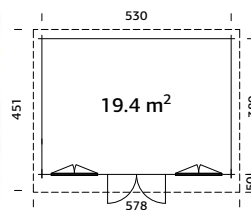

Aurelia 8,4 m²



Su ordinazione

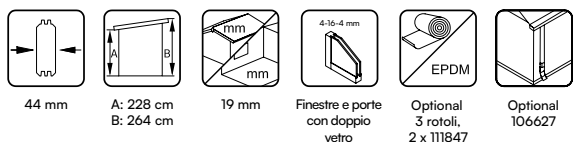
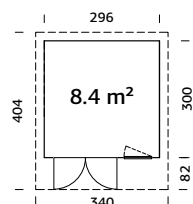

Aurelia 8,4+7,9 m²



Su ordinazione

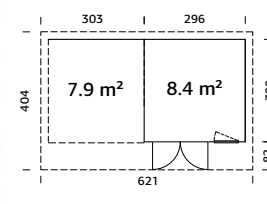

Aurelia 12,4 m²



Su ordinazione

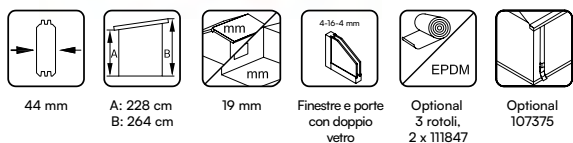
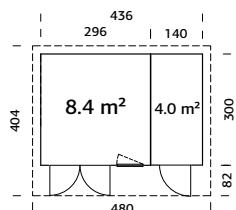

Aurelia 12,4+7,9 m²



Su ordinazione

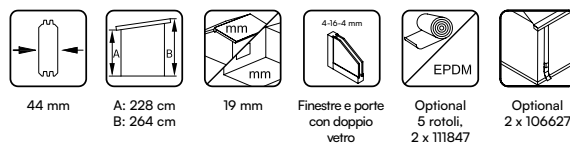
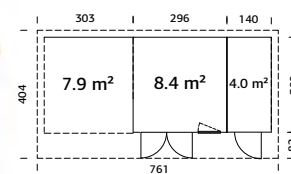

Aurelia 12,7 m²



Su ordinazione

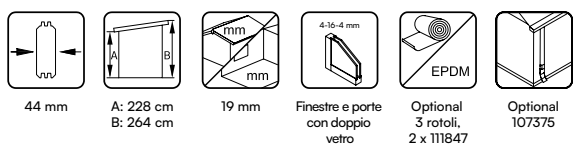
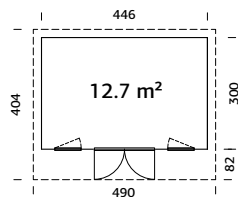

Aurelia 12,7+7,9 m²



Su ordinazione

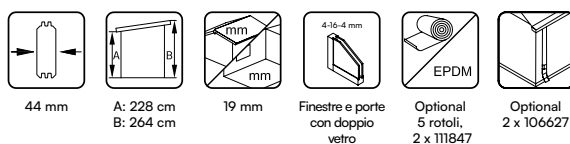
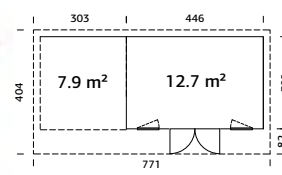

Aurelia 16,7 m²



Su ordinazione

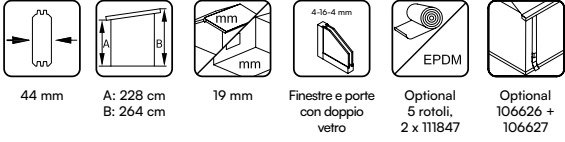
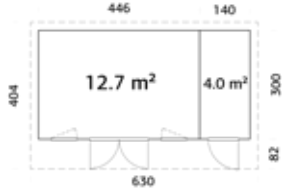

Aurelia 16,7+7,9 m²



Su ordinazione

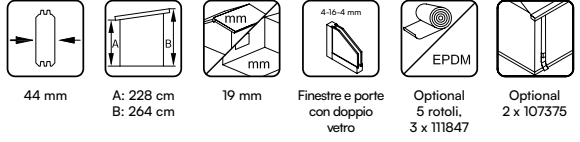
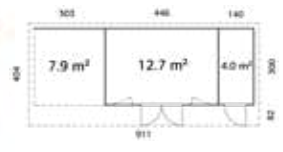

Aurelia 15,2 m²



Su ordinazione

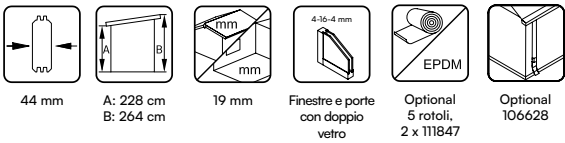
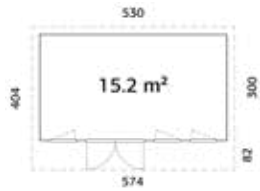

Aurelia 15,2+7,9 m²



Su ordinazione

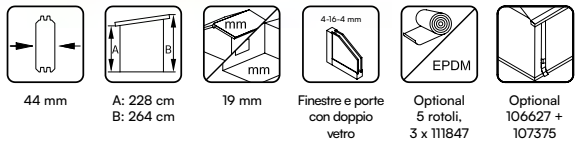
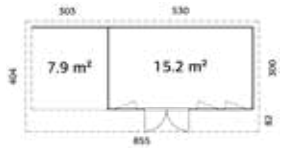

Aurelia 19,2 m²



Su ordinazione

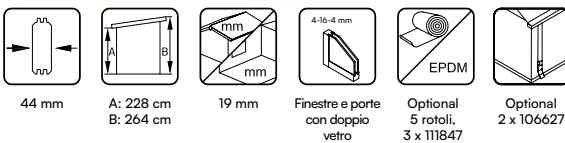
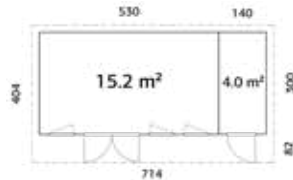

Aurelia 19,2+7,9 m²



Su ordinazione

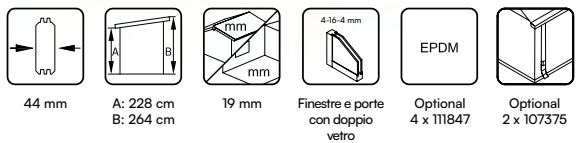
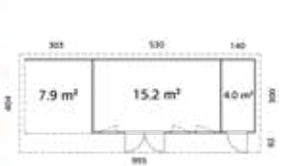



Maggiori
informazioni

10

CASETTE CON SERRAMENTI IN ALLUMINIO SCORREVOLE



Vedi colorazioni disponibili a pag. 133

Andrea 7,5 m² SCORREVOLI DOPPIO VETRO



Su ordinazione

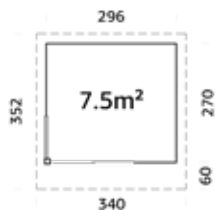

44 mm



A: 217 cm
B: 249 cm



19 mm



Doppio vetro
temperato



Optional
3 rotoli,
2x 111847



Optional
106627

Andrea 11,2 m² SCORREVOLI SINGOLO VETRO / SCORREVOLI DOPPIO VETRO



Su ordinazione

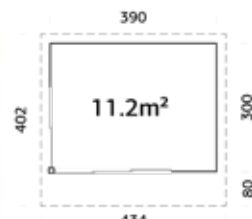

44 mm



A: 228 cm
B: 264 cm



19 mm



Singolo: 4 mm
Doppio: 4-16-4 mm
Vetro
temperato



Optional
3 rotoli,
2x 111847



Optional
107075

Andrea 11,2+7,9 m² SCORREVOLI SINGOLO VETRO / SCORREVOLI DOPPIO VETRO



Su ordinazione



44 mm



A: 228 cm
B: 264 cm



19 mm



Singolo: 4 mm
Doppio: 4-16-4 mm
Vetro
temperato



Optional
5 rotoli,
3x 111847



Optional
2 x 106627

Andrea 15,2 m² SCORREVOLI SINGOLO VETRO / SCORREVOLI DOPPIO VETRO



Su ordinazione

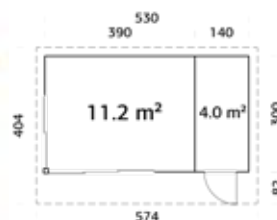

44 mm



A: 228 cm
B: 264 cm



19 mm



Singolo: 4 mm
Doppio: 4-16-4 mm
Vetro
temperato



Optional
5 rotoli,
2 x 111847



Optional
106628

Andrea 15,2+7,9 m² SCORREVOLI SINGOLO VETRO / SCORREVOLI DOPPIO VETRO



Su ordinazione

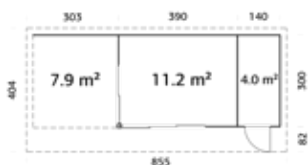

44 mm



A: 228 cm
B: 264 cm



19 mm



Singolo: 4 mm
Doppio: 4-16-4 mm
Vetro
temperato



Optional
5 rotoli,
3 x 111847



Optional
106627 +
107375

Andrea 17,1 m² SCORREVOLI SINGOLO VETRO / SCORREVOLI DOPPIO VETRO



Su ordinazione

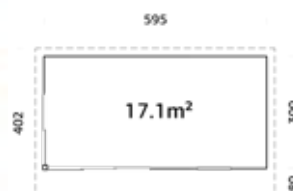

44 mm



A: 228 cm
B: 264 cm



19 mm



Singolo: 4 mm
Doppio: 4-16-4 mm
Vetro
temperato



Optional
5 rotoli,
2 x 111847



Optional
106626 +
106627

Andrea 17,1+7,9 m² SCORREVOLI SINGOLO VETRO / SCORREVOLI DOPPIO VETRO



Su ordinazione

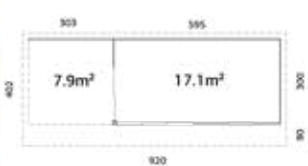

44 mm



A: 228 cm
B: 264 cm



19 mm



Singolo: 4 mm
Doppio: 4-16-4 mm
Vetro
temperato



Optional
5 rotoli,
3 x 111847



Optional
106626 +
106627

Andrea 21,1 m² SCORREVOLI SINGOLO VETRO / SCORREVOLI DOPPIO VETRO



Su ordinazione

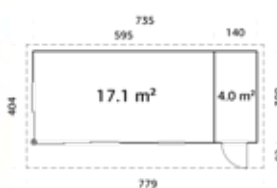

44 mm



A: 228 cm
B: 264 cm



19 mm



Singolo: 4 mm
Doppio: 4-16-4 mm
Vetro
temperato



Optional
5 rotoli,
3 x 111847



Optional
2 x 106627

Andrea 21,1 + 7,9 m² SCORREVOLI SINGOLO VETRO / SCORREVOLI DOPPIO VETRO



Su ordinazione

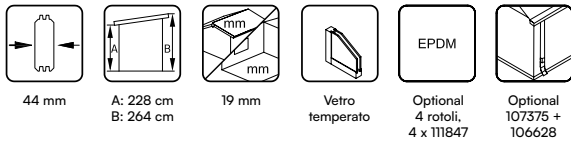
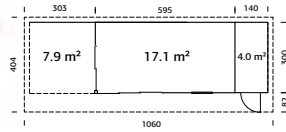

Amanda 11,2 m² SCORREVOLI SINGOLO VETRO / SCORREVOLI DOPPIO VETRO



Su ordinazione

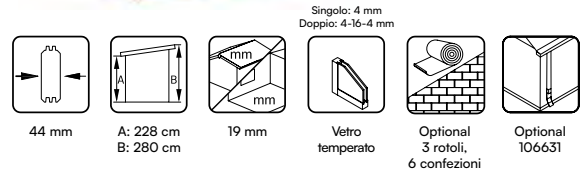
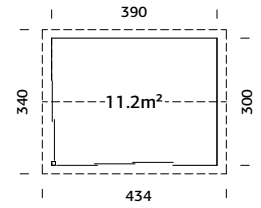

Amanda 11,2 + 7,8 m² SCORREVOLI SINGOLO VETRO / SCORREVOLI DOPPIO VETRO



Su ordinazione

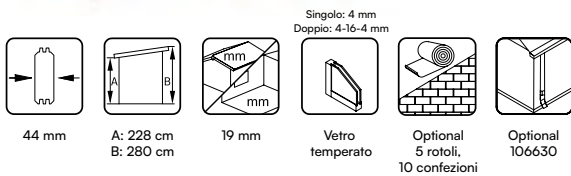
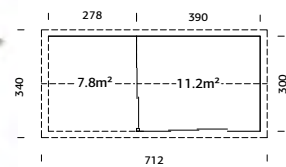

Amanda 17,1 m² SCORREVOLI SINGOLO VETRO / SCORREVOLI DOPPIO VETRO



Su ordinazione

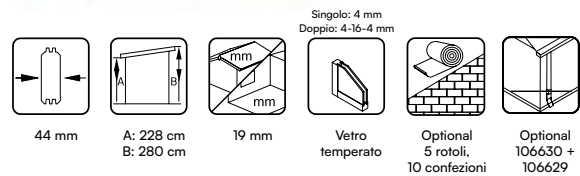
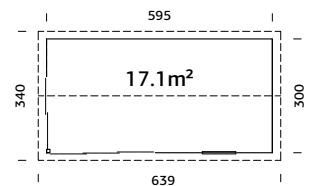

Amanda 17,1 + 7,8 m² SCORREVOLI SINGOLO VETRO / SCORREVOLI DOPPIO VETRO



Su ordinazione

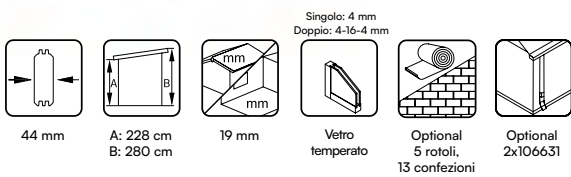
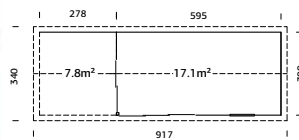

Lea 14,2 m² SCORREVOLI SINGOLO VETRO / SCORREVOLI DOPPIO VETRO



Su ordinazione

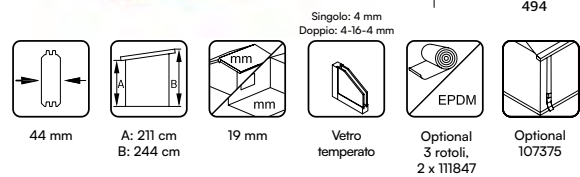
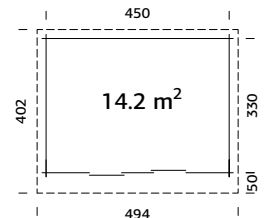

Lea 19,4 m² SCORREVOLI SINGOLO VETRO / SCORREVOLI DOPPIO VETRO



Su ordinazione

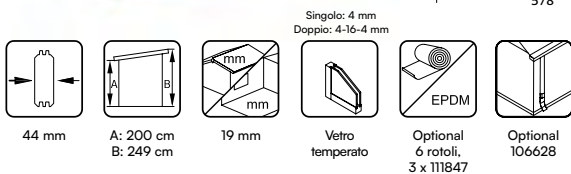
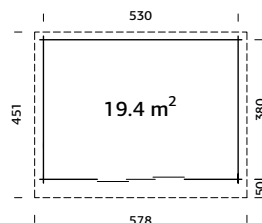

Ines 11,1 m² SCORREVOLI SINGOLO VETRO / SCORREVOLI DOPPIO VETRO



Su ordinazione

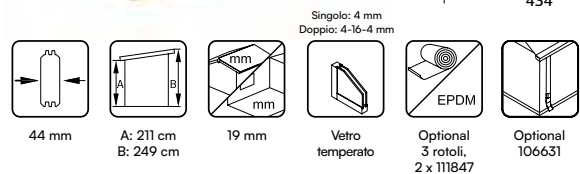
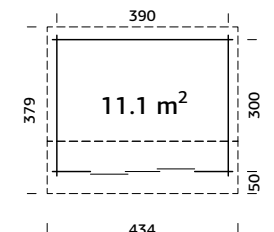

Ines 13,7 m² SCORREVOLI SINGOLO VETRO / SCORREVOLI DOPIO VETRO



Su ordinazione

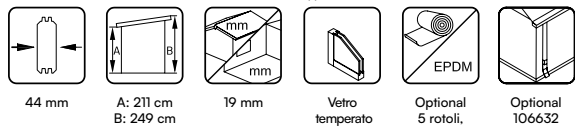
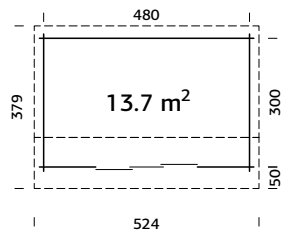

Serena 12,6 m² SET 1 SCORREVOLI SINGOLO VETRO / SCORREVOLI DOPIO VETRO



Su ordinazione

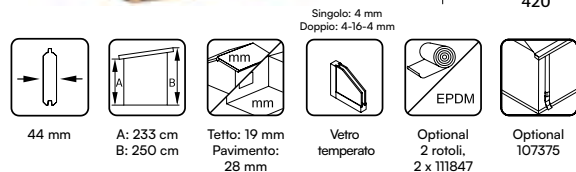
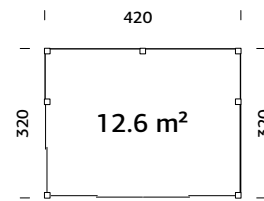

Serena 12,6 m² SET 2 SCORREVOLI SINGOLO VETRO / SCORREVOLI DOPIO VETRO



Su ordinazione

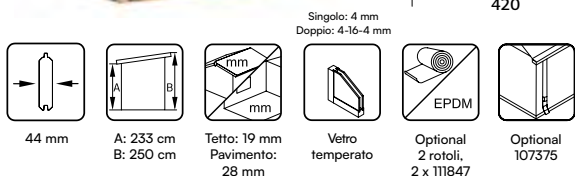
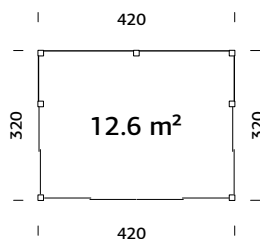

Grace 11,2 m²



Su ordinazione

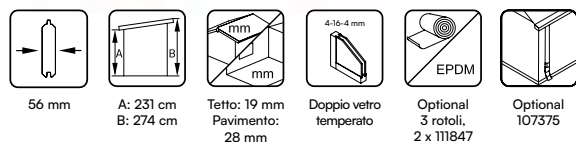
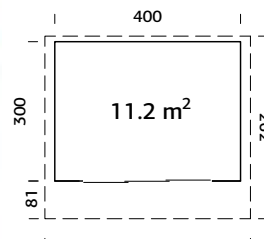

Grace 11,2+8,2 m²



Su ordinazione

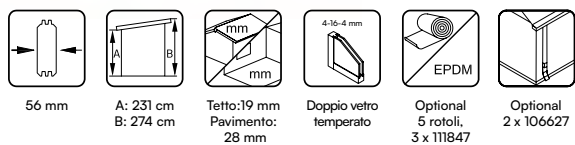
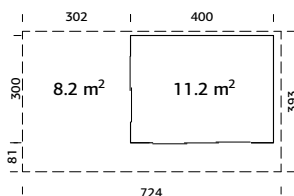

Grace 14,1 m²



Su ordinazione

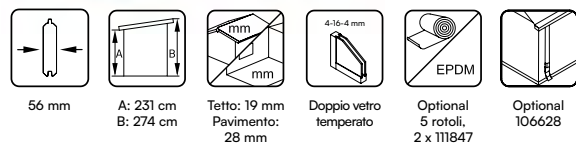
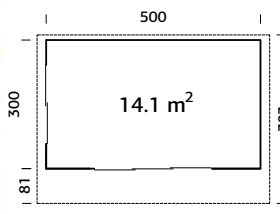

Cecilia 14,2 m²

Su ordinazione

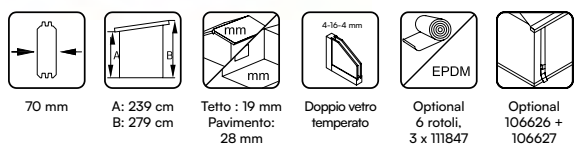
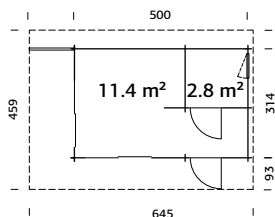

Cecilia 21,8 m²

Su ordinazione

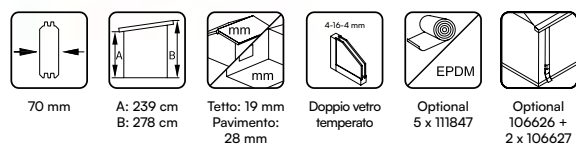
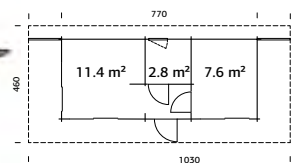

Cecilia 27,2 m²

Su ordinazione 

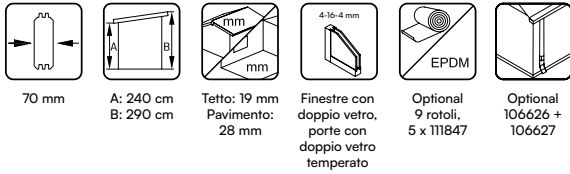
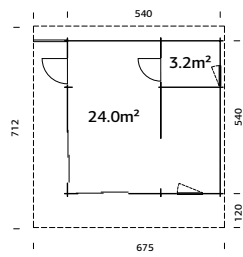

Cecilia 30,0 m²

Su ordinazione 

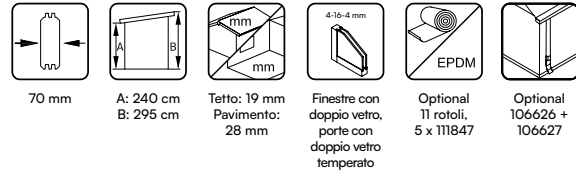
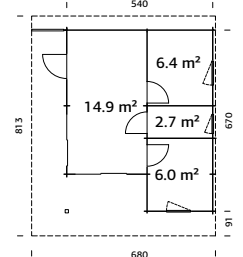

Cecilia 27,3 m²

Su ordinazione 

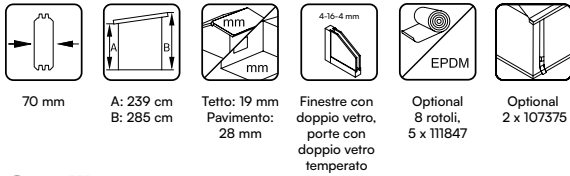
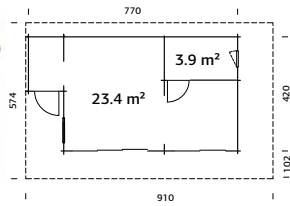

Cecilia 39,9 m²

Su ordinazione 

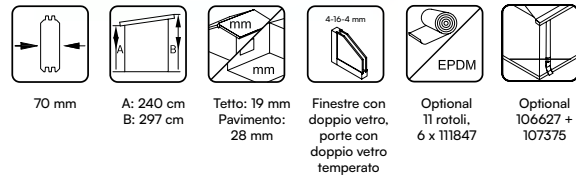
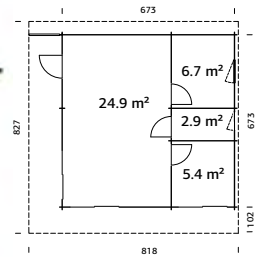

Cecilia 32,0 m²

Su ordinazione 

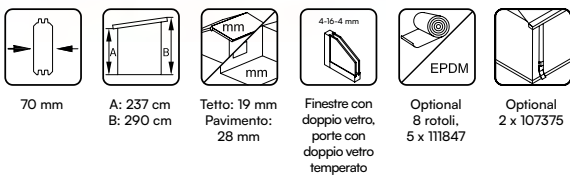
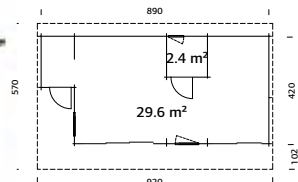



Maggiori
informazioni

11

TINY HOUSE



Pareti prefabbricate Tiny House 88 mm

Le cassette **Etta**, **Hedwig** e **Ly** hanno pareti a pannelli prefabbricate dotate di telo plastico anti-vento che rendono le cassette estremamente resistenti a pioggia e vento.

Il sistema a pannelli prefabbricati consente inoltre un montaggio facile e veloce.

Lo spessore totale dell'elemento è di 88 mm.

La struttura è predisposta per l'isolamento fino a 70 mm ed è possibile estendere l'isolamento anche a pavimento e soffitto.

La finitura degli elementi è costituita da tavole piellate di spessore 18 mm, mentre è lasciata all'utente la possibilità di rifinire l'interno a piacimento con perline in legno, pannelli in cartongesso, o similari.

NB: il rivestimento interno degli elementi e l'isolante non sono inclusi.

- Cornice 34 x 70 mm
- Telo plastico antivento
- Perline piellate 18 mm



Etta 13,6 m²

Su ordinazione

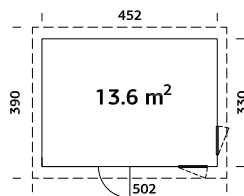

- 18 + 70 mm
- A: 203 cm
B: 294 cm
- 19 mm
- Doppio vetro temperato
- EPDM
- Optional 5 rotoli,
2 x 111847
- Optional 107375

Hedwig 13,6 m²

Su ordinazione

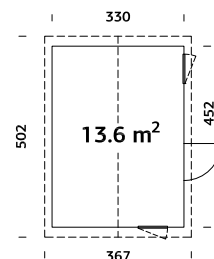

- 18 + 70 mm
- A: 203 cm
B: 297 cm
- 19 mm
- Doppio vetro
- Optional 5 rotoli,
8 confezioni
- Optional 106632

Ly 13,6 m²

Su ordinazione

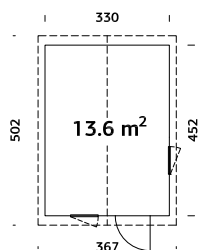

- 18 + 70 mm
- A: 203 cm
B: 297 cm
- 19 mm
- Doppio vetro
- Optional 5 rotoli,
8 confezioni
- Optional 106632



Pareti prefabbricate Tiny House 160 mm

Le Tiny House hanno pareti a pannelli prefabbricate dotate di telo plastico anti-vento che rendono le cassette estremamente resistenti a pioggia e vento.

Il sistema a pannelli prefabbricati consente inoltre un montaggio facile e veloce.

Lo spessore totale degli elementi è di 160 mm.

La struttura è predisposta per l'isolamento fino a 95 mm ed è possibile estendere l'isolamento anche a pavimento e soffitto garantendo comfort durante tutto l'anno anche nei climi più freddi.

Per una migliore ventilazione della struttura sono stati aggiunti listelli di ventilazione sotto il rivestimento esterno.

La finitura degli elementi è costituita da tavole piallate di spessore 18 mm, mentre è lasciata all'utente la possibilità di rifinire l'interno a piacimento con perline in legno, pannelli in cartongesso, o similari.

NB: il rivestimento interno degli elementi e l'isolante non sono inclusi.



Johanna 13,6 m²

Su ordinazione

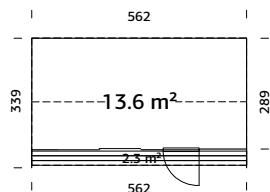

- 18 + 47 + 95 mm
- A: 276 cm
B: 296 cm
- 19 mm
- Doppio vetro
- EPDM
- Optional 106628

Johanna 19,4 m²

Su ordinazione

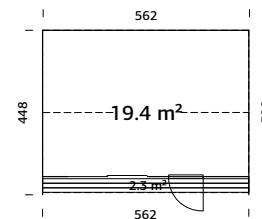

- 18 + 47 + 95 mm
- A: 270 cm
B: 296 cm
- 19 mm
- Doppio vetro
- EPDM
- Optional 106628

Johanna 22,4 m²

Su ordinazione

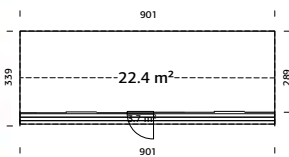

- 18 + 47 + 95 mm
- A: 276 cm
B: 296 cm
- 19 mm
- Doppio vetro
- EPDM
- Optional 106627 + 107375

Johanna 31,8 m²

Su ordinazione

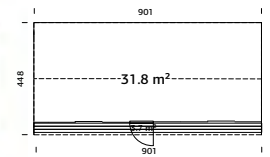

- 18 + 47 + 95 mm
- A: 270 cm
B: 296 cm
- 19 mm
- Doppio vetro
- EPDM
- Optional 106627 + 107375

Rebekka 13,6 m²

Su ordinazione 

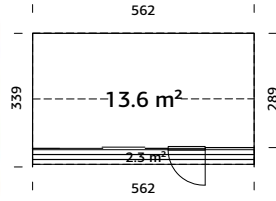

18 + 47 + 95 mm



A: 256 cm
B: 328 cm



19 mm



Doppio vetro



Optional
5 rotoli,
8 confezioni



Optional
106632

Rebekka 19,4 m²

Su ordinazione 

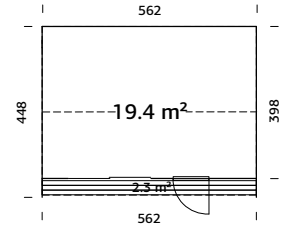

18 + 47 + 95 mm



A: 257 cm
B: 348 cm



19 mm



Doppio vetro



Optional
6 rotoli,
10 confezioni



Optional
106632

Rebekka 22,4 m²

Su ordinazione 

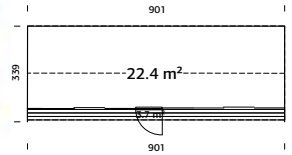

18 + 47 + 95 mm



A: 256 cm
B: 328 cm



19 mm



Doppio vetro



Optional
5 rotoli,
13 confezioni



Optional
106630 +
106631

Rebekka 31,8 m²

Su ordinazione 

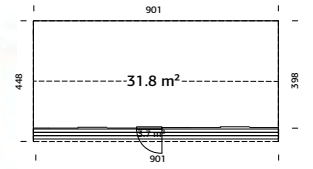

18 + 47 + 95 mm



A: 257 cm
B: 348 cm



19 mm



Doppio vetro



Optional
6 rotoli,
17 confezioni



Optional
106630 +
106631





Maggiori
informazioni

12

CASSETTE TRADIZIONALI FALDA SINGOLA



Vedi colorazioni disponibili a pag. 133

Lisa 11,5 m²



Su ordinazione

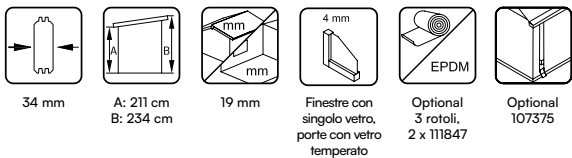
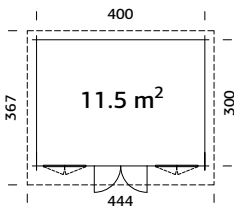

Lisa 14,2 m²



Su ordinazione

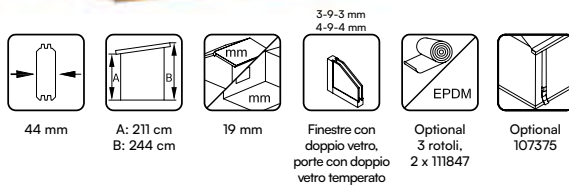
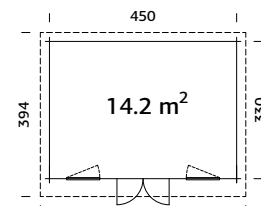

Lisa 19,4 m²



Su ordinazione

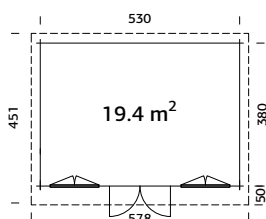

Lea 14,2 m²



Su ordinazione

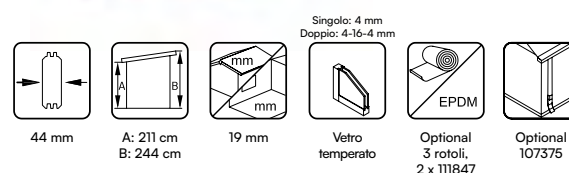
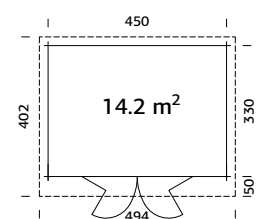

Lea 19,4 m²



Su ordinazione

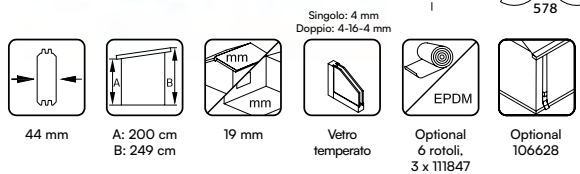
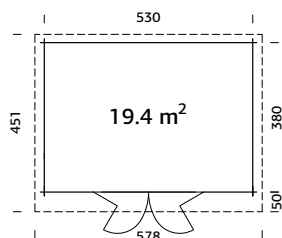

Ines 11,1 m²



Su ordinazione

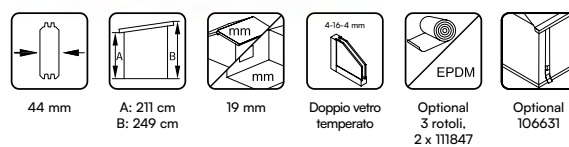
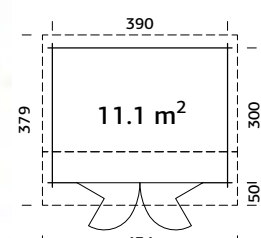

Ines 13,7 m²



Su ordinazione

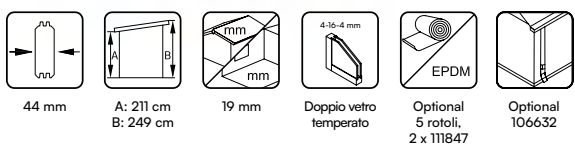
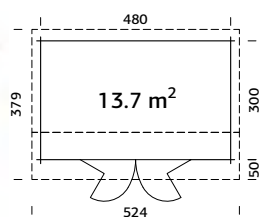

Heidi 11,7 m²



Su ordinazione

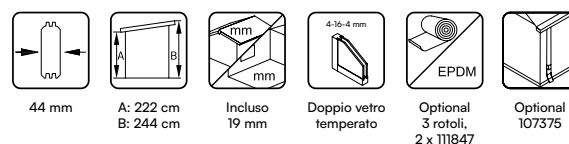
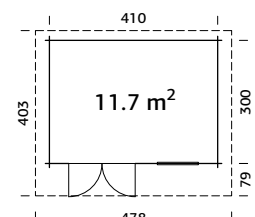

Heidi 19,7 m²

Su ordinazione 

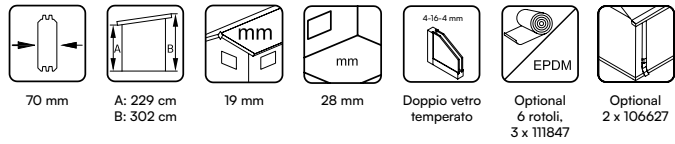

Grace 8,1+4,1 m²

Su ordinazione 

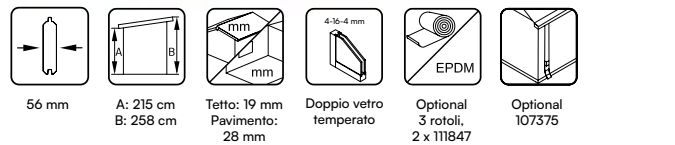

Grace 12,1+4,1 m²

Su ordinazione 

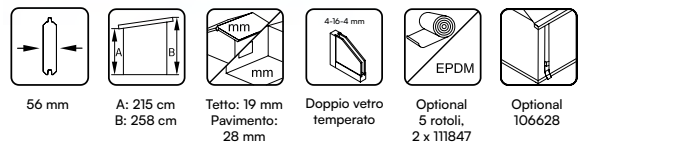

Ella 6,9 m²

Su ordinazione 

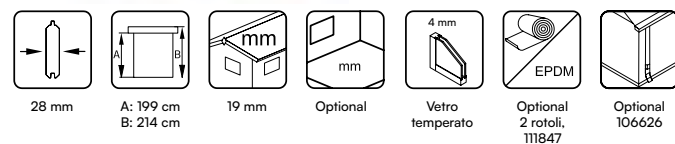
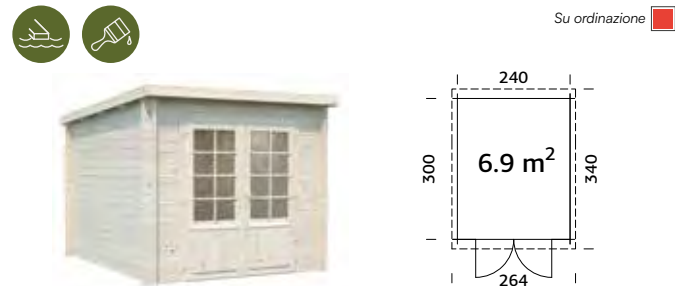

Heidi 22,8 m²

Su ordinazione 

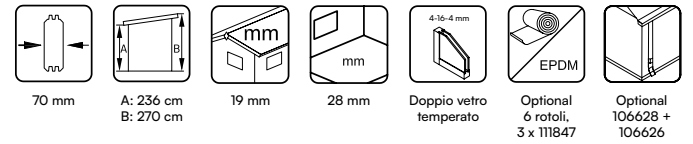

Grace 8,1+8,1 m²

Su ordinazione 

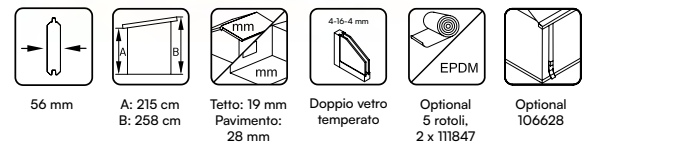

Grace 14,5 m²

Su ordinazione 

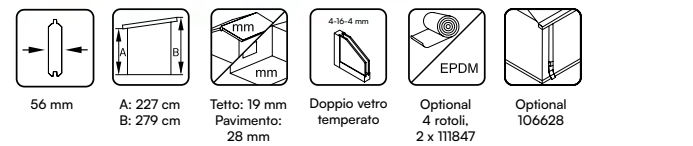
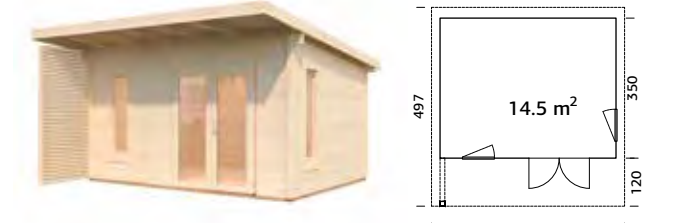

Ella 8,7 m²

Su ordinazione 

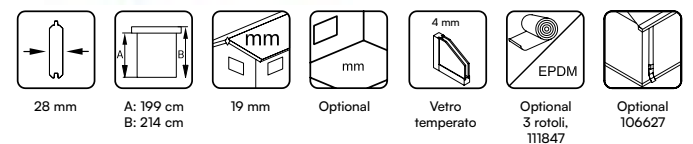
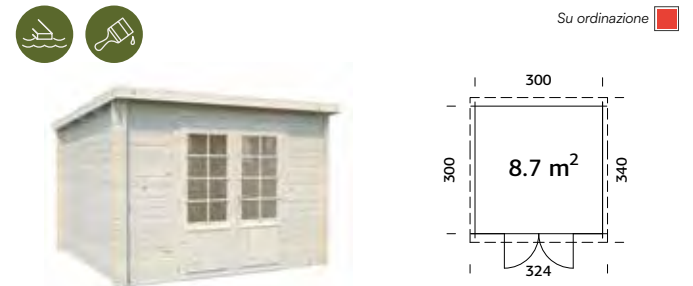

Ella 6,9+8,2 m²



Su ordinazione

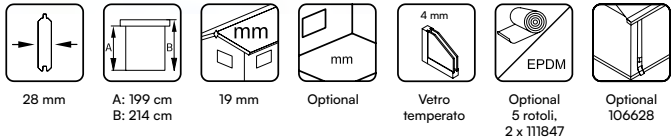
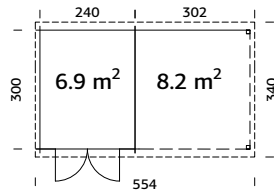

28 mm A: 199 cm B: 214 cm 19 mm Optional 4 mm Vetro temperato Optional 5 rotoli, 2 x 111847 Optional 106628

Ella 8,7+8,2 m²



Su ordinazione

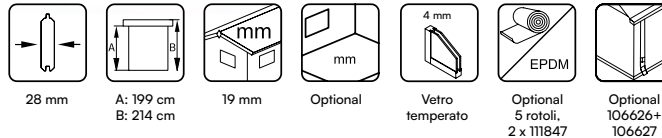
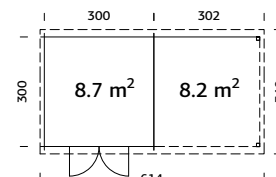

28 mm A: 199 cm B: 214 cm 19 mm Optional 4 mm Vetro temperato Optional 5 rotoli, 2 x 111847 Optional 106626+106627

Ella 6,9+10,0 m²



Su ordinazione

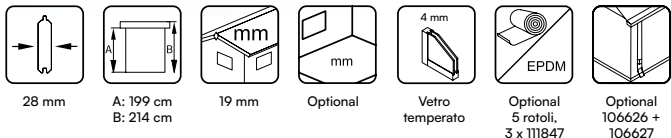
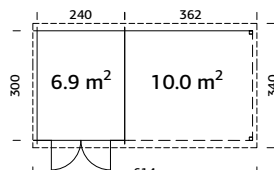

28 mm A: 199 cm B: 214 cm 19 mm Optional 4 mm Vetro temperato Optional 5 rotoli, 3 x 111847 Optional 106626 + 106627

Ella 8,7+10,0 m²



Su ordinazione

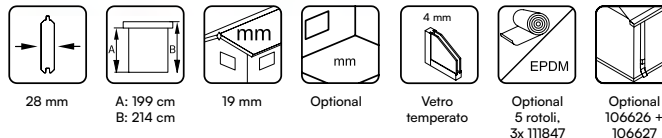
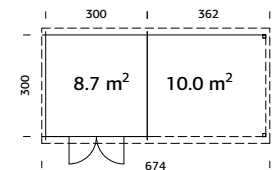

28 mm A: 199 cm B: 214 cm 19 mm Optional 4 mm Vetro temperato Optional 5 rotoli, 3x 111847 Optional 106626 + 106627

Ella 13,1 m²



Su ordinazione

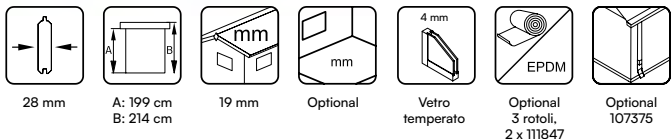
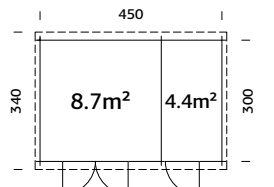

28 mm A: 199 cm B: 214 cm 19 mm Optional 4 mm Vetro temperato Optional 3 rotoli, 2 x 111847 Optional 107375

Ella 13,1+3,9 m²



Su ordinazione

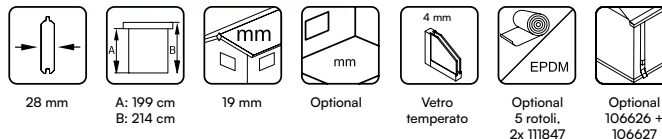
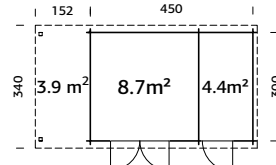

28 mm A: 199 cm B: 214 cm 19 mm Optional 4 mm Vetro temperato Optional 5 rotoli, 2x 111847 Optional 106626 + 106627

Alice 4,7 m²

Su ordinazione

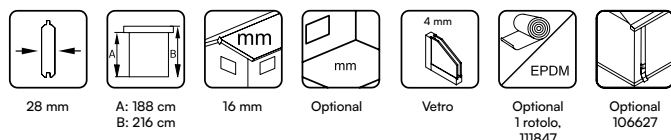
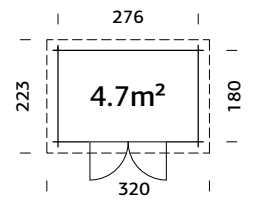

28 mm A: 188 cm B: 216 cm 16 mm Optional 4 mm Vetro Optional 1 rotolo, 111847 Optional 106627

Alice 9,0 m²

Su ordinazione

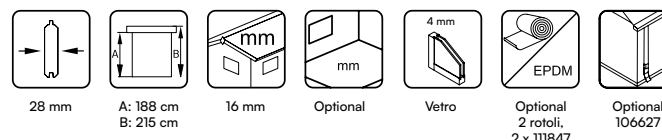
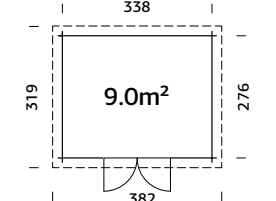

28 mm A: 188 cm B: 215 cm 16 mm Optional 4 mm Vetro Optional 2 rotoli, 2 x 111847 Optional 106627



Maggiori
informazioni

13

CASETTE TRADIZIONALI FALDA DOPPIA



Vedi colorazioni disponibili a pag. 133

Vivian 6,9 m²



Su ordinazione

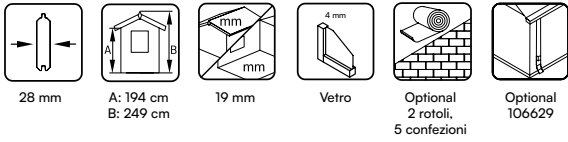
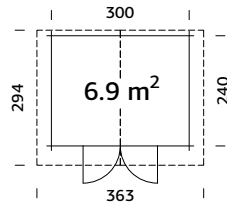

Emma 4,6 m²



Su ordinazione

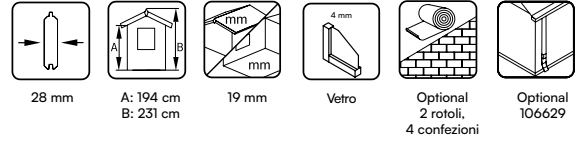
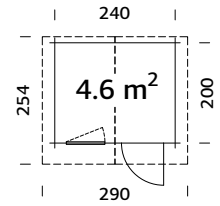

Emma 10,4 m²



Su ordinazione

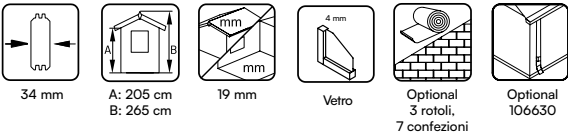
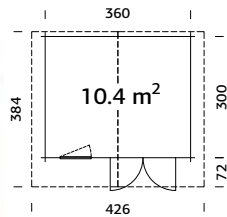

Emma 10,4+4,2 m²



Su ordinazione

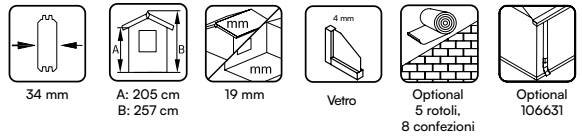
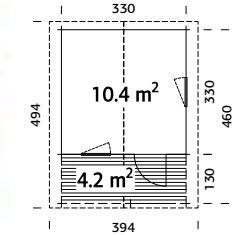

Emma 14,2 m²



Su ordinazione

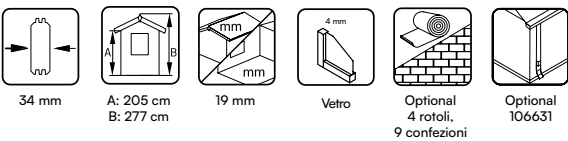
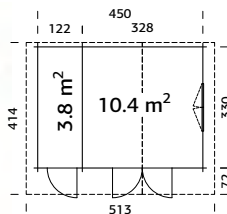

Sally 10,2 m²



Su ordinazione

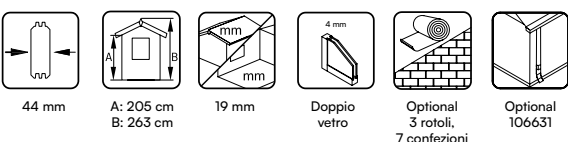
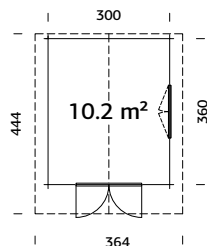

Sally 10,2 m²



Su ordinazione

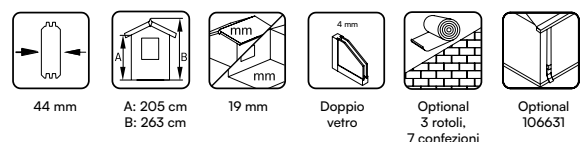
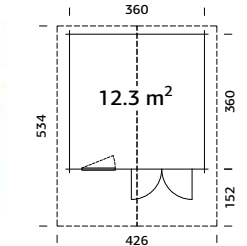

Sally 19,1 m²



Su ordinazione

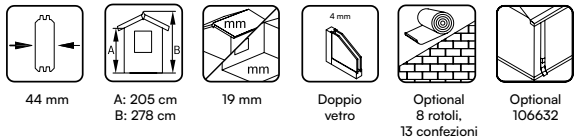
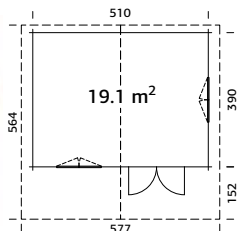

Helena 15,1 m²



Su ordinazione

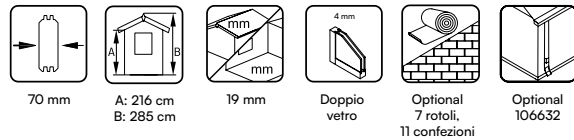
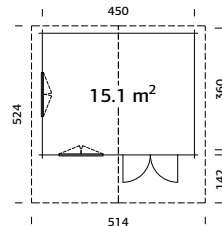

Helena 18,6 m²



Su ordinazione

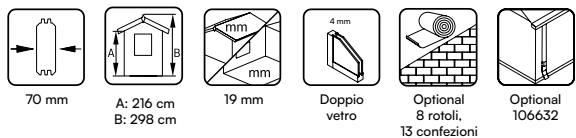
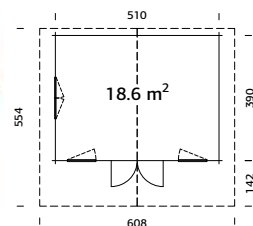

Helena 24,6 m²



Su ordinazione

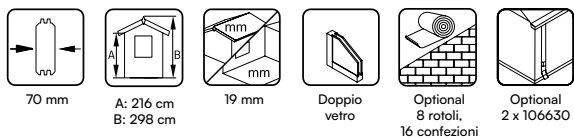
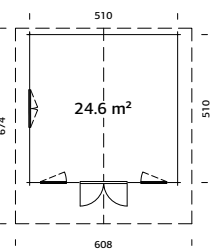

Irene 19,0 m²



Su ordinazione

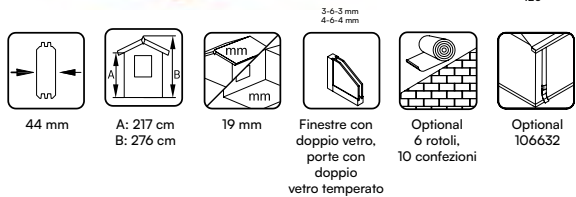
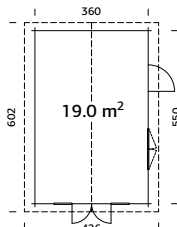

Irene 21,9+5,2 m²



Su ordinazione

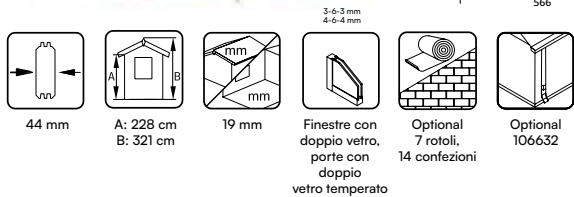
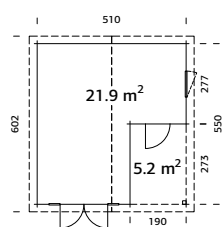

Irene 23,9 m²



Su ordinazione

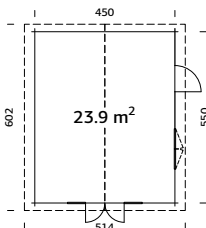

Irene 27,7 m²



Su ordinazione

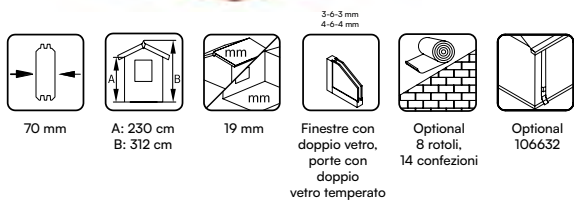
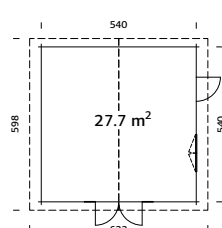

Irene 19,0+16,2 m²



Su ordinazione

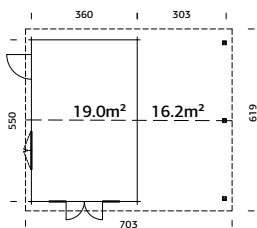

44 mm



A: 222 cm
B: 316 cm



19 mm

3-6-3 mm
4-6-4 mm
Finestre con doppio vetro.
porte con doppio vetro temperato



Optional
8 rotoli,
18 confezioni



Optional
106630

Irene 19,0+33,2 m²



Su ordinazione

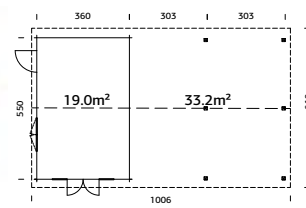

44 mm



A: 222 cm
B: 316 cm



19 mm

3-6-3 mm
4-6-4 mm
Finestre con doppio vetro.
porte con doppio vetro temperato



Optional
10 rotoli,
24 confezioni



Optional
106632

Iris 9,6 m²



Su ordinazione

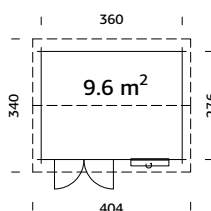

28 mm



A: 211 cm
B: 260 cm



16 mm

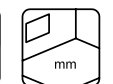

19 mm



4 mm

Finestre con doppio vetro,
porte con doppio vetro temperato



Optional
3 rotoli,



Optional
106630

Iris 11,1 m²



Su ordinazione

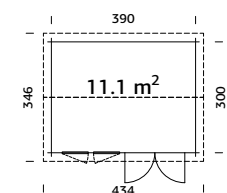

44 mm



A: 211 cm
B: 251 cm



19 mm

3-6-3 mm
4-6-4 mm
Finestre con doppio vetro,
porte con doppio vetro temperato



Optional
3 rotoli



Optional
106631

Iris 19,1 m²



Su ordinazione

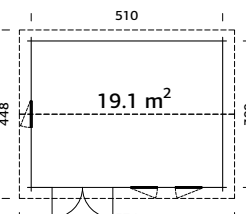

44 mm



A: 211 cm
B: 262 cm



19 mm

3-6-3 mm
4-6-4 mm
Finestre con doppio vetro,
porte con doppio vetro temperato



Optional
6 rotoli,



Optional
106632

Susanna 12,4 m²



Su ordinazione

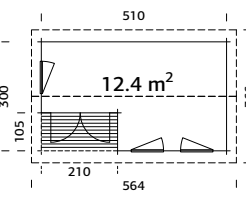

44 mm



A: 205 cm
B: 263 cm



19 mm

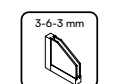

Doppio vetro



Optional
5 rotoli,



Optional
106632

Susanna 16,4 m²



Su ordinazione

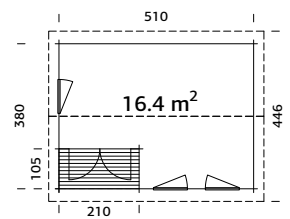

44 mm



A: 205 cm
B: 278 cm



19 mm

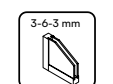

Doppio vetro



Optional
6 rotoli,



Optional
106632

Claudia 14,2 m²



Su ordinazione

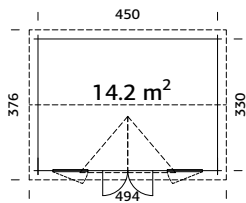

| | | | | | | |
|-------|------------------------|-------|----------------------|---|---------------------------------|-----------------|
| | | | | | | |
| 44 mm | A: 219 cm B: 337 cm | 19 mm | 3-6-3 mm 4-6-4 mm | Finestre con doppio vetro, porte con doppio vetro temperato | Optional 3 rotoli, 9 confezioni | Optional 106631 |

Claudia 11,5 m² PENT



Su ordinazione

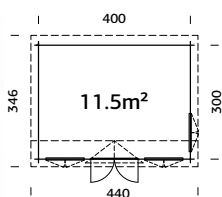

| | | | | | | |
|-------|------------------------|-------|----------|------|-------------------------------|-----------------|
| | | | | | | |
| 34 mm | A: 210 cm B: 249 cm | 19 mm | 3-6-3 mm | EPDM | Optional 3 rotoli, 2 x 111847 | Optional 106631 |

Kendra 18,4 m²



Su ordinazione

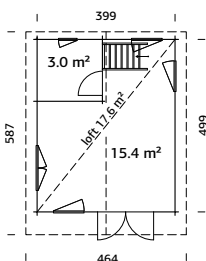

| | | | | | | |
|-------|------------------------|-------|-----------|---|----------------------------------|--|
| | | | | | | |
| 70 mm | A: 283 cm B: 432 cm | 19 mm | 4-16-4 mm | Finestre con doppio vetro, porte con doppio vetro temperato | Optional 9 rotoli, 13 confezioni | |

Sandra 25,6+11,1 m²



Su ordinazione

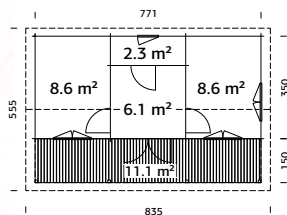

| | | | | | | |
|-------|------------------------|-------|-----------|--------------|----------------------------------|--|
| | | | | | | |
| 44 mm | A: 239 cm B: 335 cm | 19 mm | 4-16-4 mm | Doppio vetro | Optional 9 rotoli, 18 confezioni | |

Claudia 19,4 m²



Su ordinazione

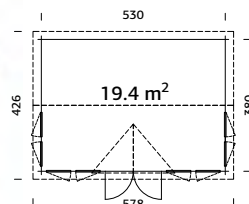

| | | | | | | |
|-------|------------------------|-------|----------------------|---|----------------------------------|-----------------|
| | | | | | | |
| 44 mm | A: 222 cm B: 363 cm | 19 mm | 3-6-3 mm 4-6-4 mm | Finestre con doppio vetro, porte con doppio vetro temperato | Optional 7 rotoli, 12 confezioni | Optional 106632 |

Claudia 19,4 m² PENT



Su ordinazione

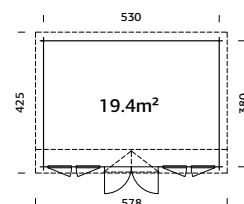

| | | | | | | |
|-------|------------------------|-------|----------------------|------|-------------------------------|-----------------|
| | | | | | | |
| 44 mm | A: 211 cm B: 249 cm | 19 mm | 3-9-3 mm 4-9-4 mm | EPDM | Optional 6 rotoli, 3 x 111847 | Optional 106632 |

Sandra 21,5+3,7 m²



Su ordinazione

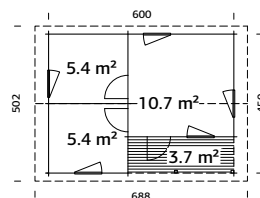

| | | | | | | |
|-------|------------------------|-------|-------|--------------|----------------------------------|--|
| | | | | | | |
| 70 mm | A: 230 cm B: 320 cm | 19 mm | 28 mm | Doppio vetro | Optional 7 rotoli, 14 confezioni | |

Sandra 29,9 m²



Su ordinazione

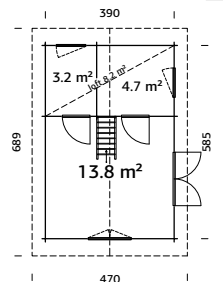

| | | | | | | |
|-------|------------------------|-------|-----------|--------------|----------------------------------|--|
| | | | | | | |
| 44 mm | A: 239 cm B: 370 cm | 19 mm | 4-16-4 mm | Doppio vetro | Optional 8 rotoli, 15 confezioni | |

Emily 39,2 m²

Su ordinazione 

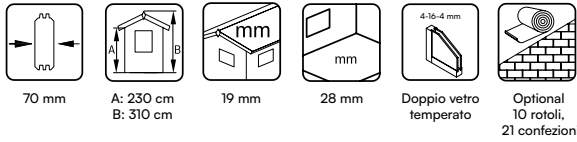
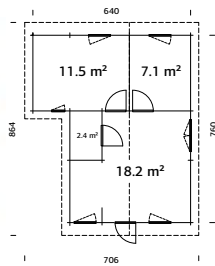

Emily 40,1+5,2 m²

Su ordinazione 

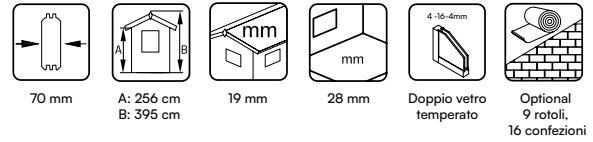
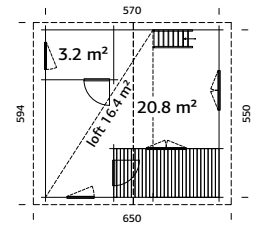

Anna 26,8 m²

Su ordinazione 

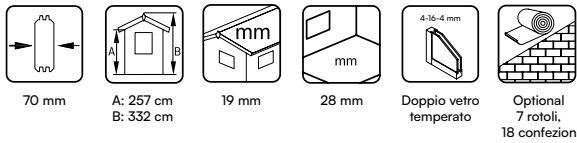
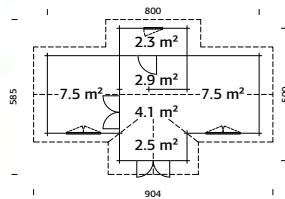

Anna 26,8+1,9 m²

Su ordinazione 

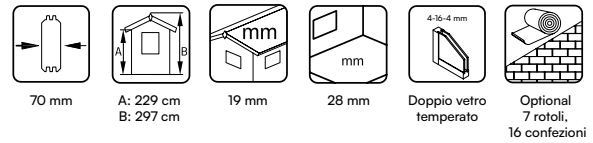
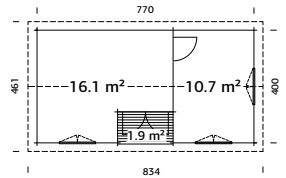

Klara 17,0 m²

Su ordinazione 

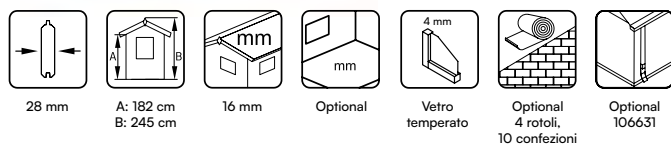
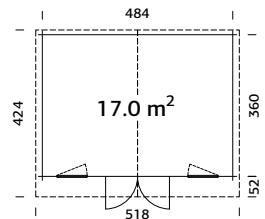



Maggiori
informazioni

14

GIARDINI D'INVERNO



Vedi colorazioni disponibili a pag. 133

Isabella 10,9 m²



Su ordinazione

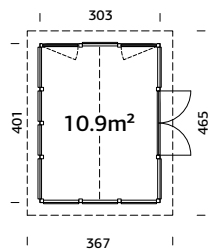

90 x 90 mm



A: 221 cm
B: 297 cm



19 mm



4 mm
Vetro temperato



mm



Optional
3 rotoli,
8 confezioni



Optional
106631



Su ordinazione

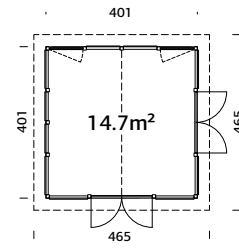

90 x 90 mm



A: 221 cm
B: 315 cm



19 mm



4 mm
Vetro temperato



mm



Optional
4 rotoli,
9 confezioni



Optional
106631

Isabella 22,2 m²



Su ordinazione

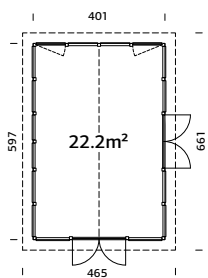

90 x 90 mm



A: 221 cm
B: 315 cm



19 mm



4 mm
Vetro temperato



mm



Optional
5 rotoli,
10 confezioni



Optional
106629 +
106630



Lumi 11,6 m² SCORREVOLI SINGOLO VETRO / SCORREVOLI DOPPIO VETRO



Su ordinazione

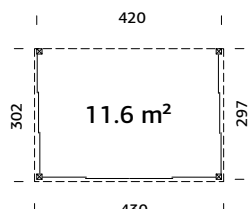

120 x 120 mm



A: 226 cm
B: 273 cm



19 mm/-



Vetro temperato



Optional
3 rotoli,
2 x 111874



Optional
107375



Su ordinazione

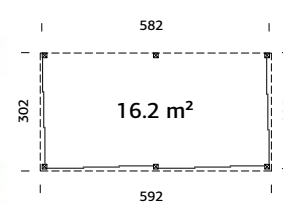

120 x 120 mm



A: 226 cm
B: 273 cm



19 mm/-



Vetro temperato



Optional
4 rotoli,
3 x 111874



Optional
106628

Lumi 16,6 m² SCORREVOLI SINGOLO VETRO / SCORREVOLI DOPPIO VETRO



Su ordinazione

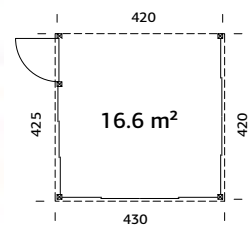

120 x 120 mm



A: 230 cm
B: 276 cm



19 mm/-



Vetro temperato



Optional
3 rotoli,
2 x 111874



Optional
107375



Su ordinazione

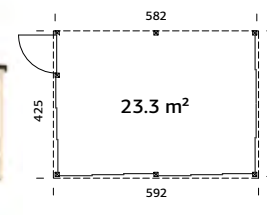

120 x 120 mm



A: 230 cm
B: 276 cm



19 mm/-



Vetro temperato



Optional
6 rotoli,
3 x 111874



Optional
106628

Saga 11,6 m² SCORREVOLI SINGOLO VETRO / SCORREVOLI DOPPIO VETRO



Su ordinazione

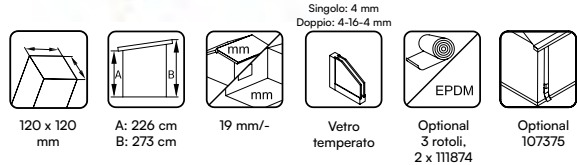
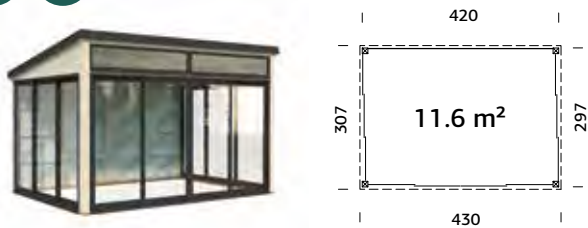

Saga 16,2 m² SCORREVOLI SINGOLO VETRO / SCORREVOLI DOPPIO VETRO



Su ordinazione

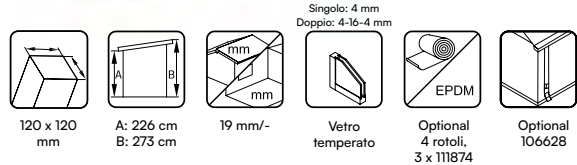
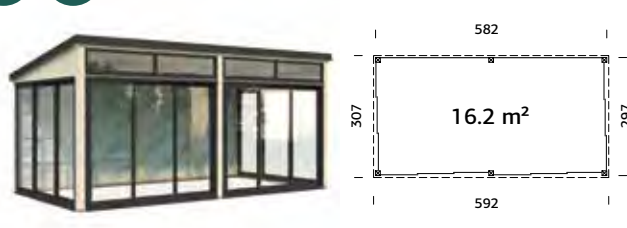

Saga 16,6 m² SCORREVOLI SINGOLO VETRO / SCORREVOLI DOPPIO VETRO



Su ordinazione

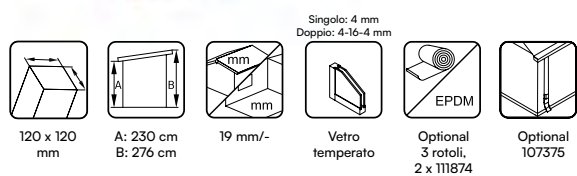
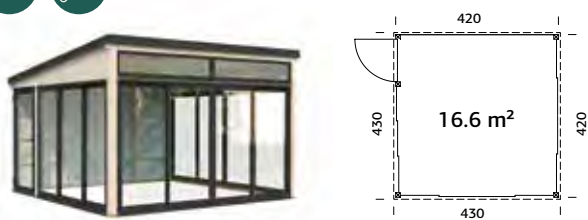

Saga 23,3 m² SCORREVOLI SINGOLO VETRO / SCORREVOLI DOPPIO VETRO



Su ordinazione

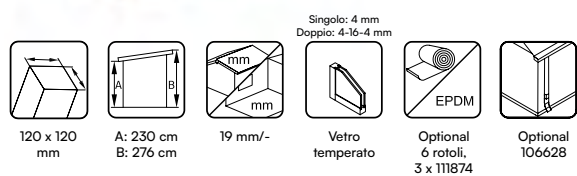
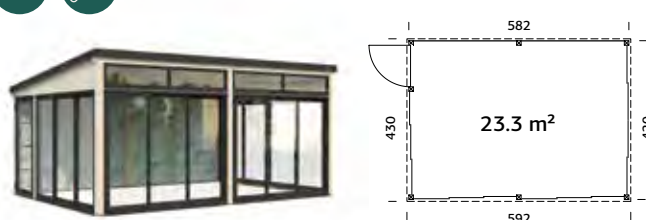

Emilia Casetta 4,0 m²

Su ordinazione 

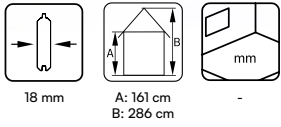
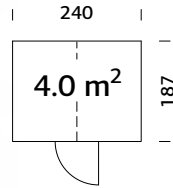

Emilia 5,4 m²

Su ordinazione 

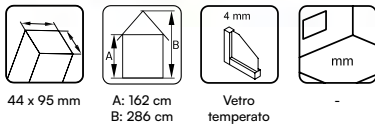
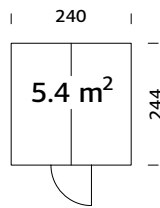

Emilia 8,2 m²

Su ordinazione 

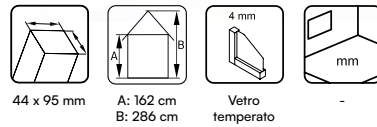
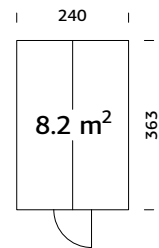

Emilia 5,4+4,0 m²

Su ordinazione 

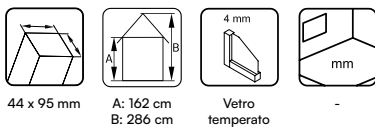
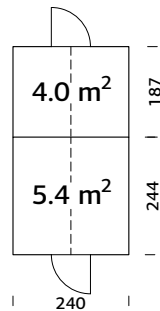

Emilia 8,2+4,0 m²

Su ordinazione 

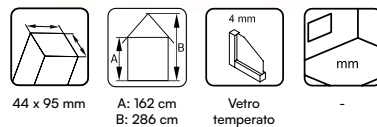
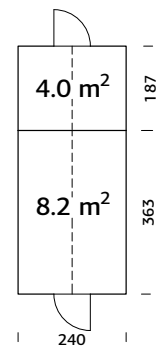

Emilia 13,8 m²

Su ordinazione 

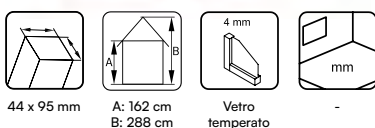
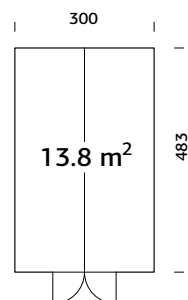

Emilia 19,1 m²

Su ordinazione 

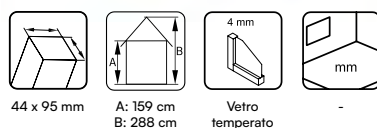
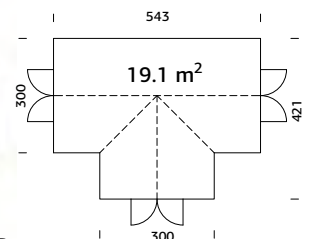



Maggiori
informazioni

15

PAVILION E CHIOSCHI



Vedi colorazioni disponibili a pag. 133

Hanna 14,1m²



Su ordinazione

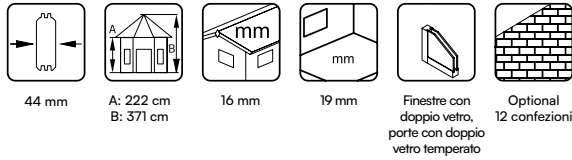
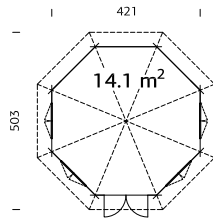

Hanna 20,3m²



Su ordinazione

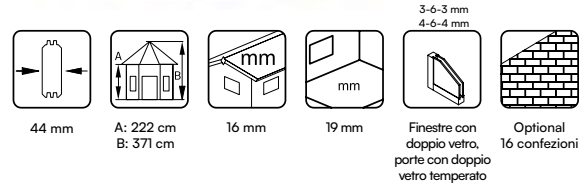
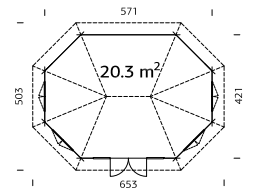

Melanie 7,0m²



Su ordinazione

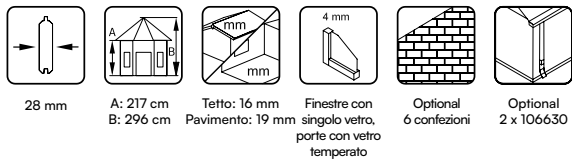
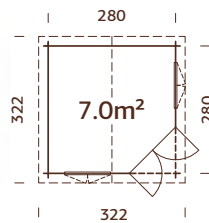

Melanie 6,9m²



Su ordinazione

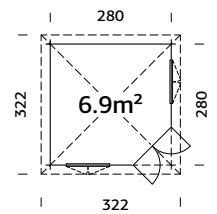

Melanie 9,9m²



Su ordinazione

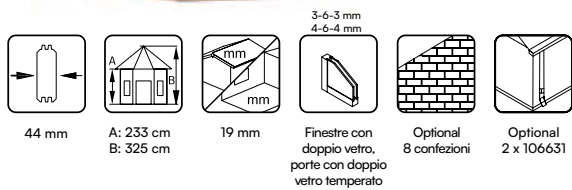
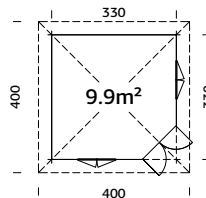

Melanie 7,0+8,1m²



Su ordinazione

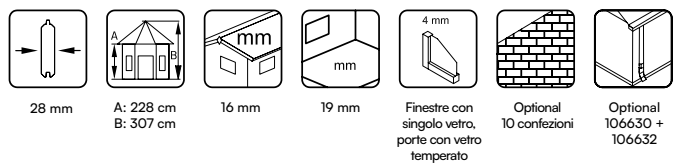
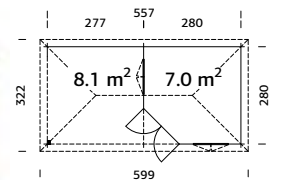

Veronica 2 6,7m²



Su ordinazione

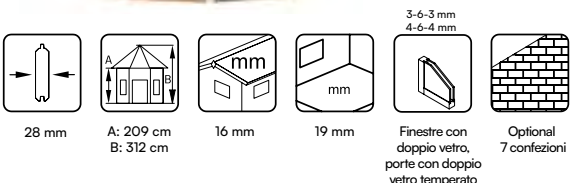
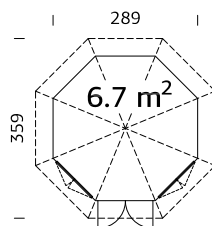

Veronica 4 6,7m²



Su ordinazione

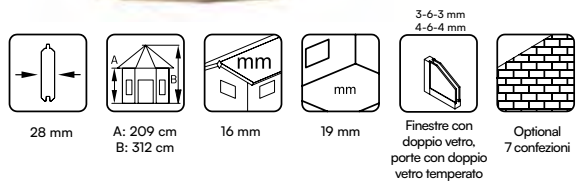
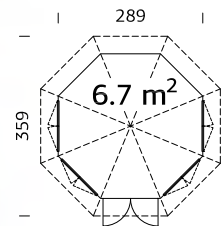

Veronica 4 9,2 m²

Su ordinazione

337
406
9.2 m²

34 mm A: 221 cm 16 mm 19 mm Finestre con doppio vetro, porte con doppio vetro temperato Optional 9 confezioni

Veronica 7 9,2 m²

Su ordinazione

337
406
9.2 m²

34 mm A: 221 cm 16 mm 19 mm Finestre con doppio vetro, porte con doppio vetro temperato Optional 9 confezioni

Bianca Chiosco set 104 8,3 m²

Su ordinazione

300
384
8.3 m²
300
384

28 mm A: 210 cm 19 mm Optional Optional 6 rotoli, 9 confezioni Optional 2 x 106630



Bianca Chiosco set 105 8,3 m²

Su ordinazione

300
384
8.3 m²
300
384

28 mm A: 210 cm 19 mm Optional Optional 6 rotoli, 9 confezioni Optional 2 x 106630

Bianca Chiosco set 106 8,3 m²

Su ordinazione

300
384
8.3 m²
300
384

28 mm A: 210 cm 19 mm Optional Optional 6 rotoli, 9 confezioni Optional 2 x 106630

Bianca Chiosco set 111 16,6 m²

Su ordinazione

588
384
16.6 m²
384
672

28 mm A: 210 cm 19 mm Optional Optional 9 rotoli, 14 confezioni Optional 106629 + 2 x 106630

Bianca Chiosco set 112 16,6 m²

Su ordinazione

588
384
16.6 m²
384
672

28 mm A: 210 cm 19 mm Optional Optional 9 rotoli, 14 confezioni Optional 2 x 106630 + 106629

Lenna Chiosco set 304 8,3 m²



Su ordinazione

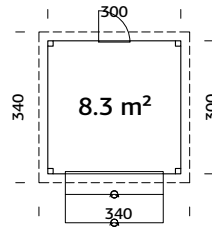

28 mm



A: 210 cm
B: 245 cm



19 mm



Optional



Optional
2 rotoli,
2 x 111847



Optional
106627

Lenna Chiosco set 305 8,3 m²



Su ordinazione

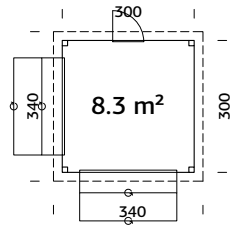

28 mm



A: 210 cm
B: 245 cm



19 mm



Optional



Optional
2 rotoli,
2 x 111847



Optional
106627

Lenna Chiosco set 306 8,3 m²



Su ordinazione

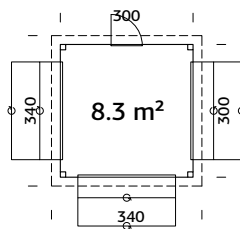

28 mm



A: 210 cm
B: 245 cm



19 mm



Optional



Optional
2 rotoli,
2 x 111847



Optional
106627



Lenna Chiosco set 311 16,6 m²



Su ordinazione

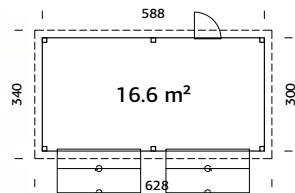

28 mm



A: 210 cm
B: 245 cm



19 mm



Optional



Optional
4 rotoli,
2 x 111847



Optional
106626 +
106627

Lenna Chiosco set 312 16,6 m²



Su ordinazione

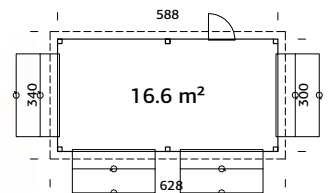

28 mm



A: 210 cm
B: 245 cm



19 mm



Optional



Optional
4 rotoli,
2 x 111847



Optional
106626 +
106627

Kira 7,7 m²



Su ordinazione

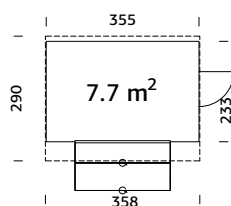

16 + 32 mm



A: 209 cm
B: 264 cm



19 mm



Optional
2 rotoli,
111874



Optional
106627





Maggiori
informazioni

16

KOTA GRILL



Vedi colorazioni disponibili a pag. 133

Eva 8,7 m²



Su ordinazione

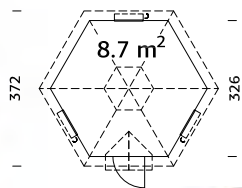

44 mm



A: 133 cm
B: 315 cm



19 mm



Doppio
vetro



Optional
9 confezioni



Eva 11,4 m²



Su ordinazione

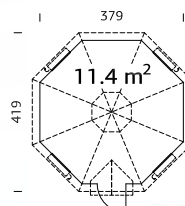

44 mm



A: 133 cm
B: 340 cm



19 mm



Doppio
vetro



Optional
12 confezioni





Maggiori
informazioni

17

PERGOLE E GAZEBO



Vedi colorazioni disponibili a pag. 133

Betty 9,0 m²



Su ordinazione

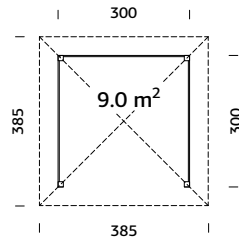

120 x 120 mm



A: 226 cm
B: 315 cm



19 mm



Optional



Optional
8 confezioni

Betty 9,9 m²



Su ordinazione

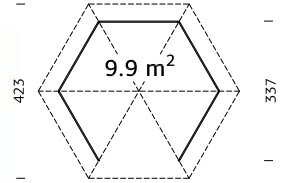

120 x 120 mm



A: 226 cm
B: 325 cm



19 mm



Optional



Optional
9 confezioni

Betty 18,0 m²



Su ordinazione

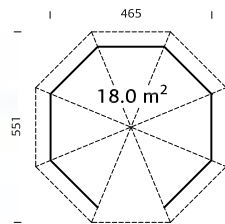

120 x 120 mm



A: 227 cm
B: 358 cm



19 mm



Optional



Optional
14 confezioni

Betty 25,0 m²



Su ordinazione

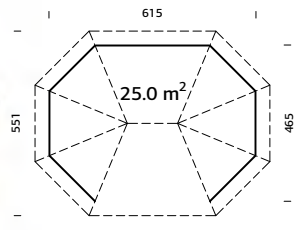

120 x 120 mm



A: 226 cm
B: 357 cm



19 mm



Optional



Optional
17 confezioni



Bianca Set 101 8,3 m²



Su ordinazione

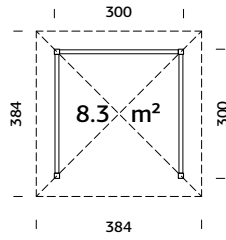

- 120 x 120 mm
- A: 210 cm
B: 319 cm
- 19 mm
- Optional
- Optional
6 rotoli,
9 confezioni
- Optional
2 x 106630

Bianca Set 103 8,3 m²



Su ordinazione

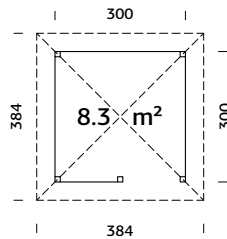

- 120 x 120 mm
- A: 210 cm
B: 319 cm
- 19 mm
- Optional
- Optional
6 rotoli,
9 confezioni
- Optional
2 x 106630

Bianca Set 109 16,6 m²



Su ordinazione

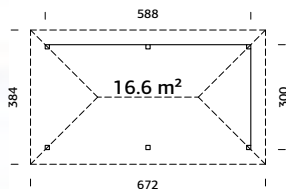

- 120 x 120 mm
- A: 210 cm
B: 319 cm
- 19 mm
- Optional
- Optional
9 rotoli,
14 confezioni
- Optional
2 x 106630
+ 106629

Bianca Set 108 16,6 m²



Su ordinazione

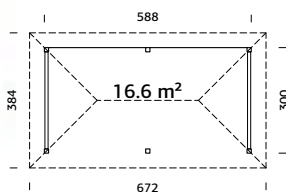

- 120 x 120 mm
- A: 210 cm
B: 319 cm
- 19 mm
- Optional
- Optional
9 rotoli,
14 confezioni
- Optional
106629 +
2 x 106630

Bianca Set 102 8,3 m²



Su ordinazione

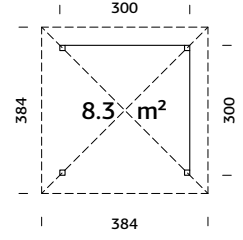

- 120 x 120 mm
- A: 210 cm
B: 319 cm
- 19 mm
- Optional
- Optional
6 rotoli,
9 confezioni
- Optional
2 x 106630

Bianca Set 107 16,6 m²



Su ordinazione

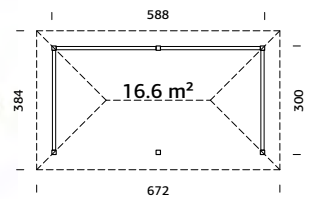

- 120 x 120 mm
- A: 210 cm
B: 319 cm
- 19 mm
- Optional
- Optional
9 rotoli,
14 confezioni
- Optional
106629 +
2 x 106630



Bianca Set 110 16,6 m²



Su ordinazione

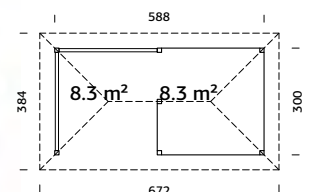

- 120 x 120 mm
- A: 210 cm
B: 319 cm
- 19 mm
- Optional
- Optional
9 rotoli,
14 confezioni
- Optional
106629 +
2 x 106630

Lenna Set 301 8,3 m²



Su ordinazione

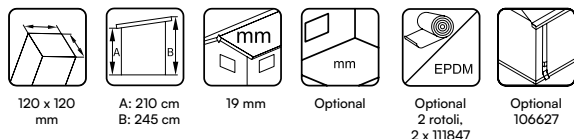
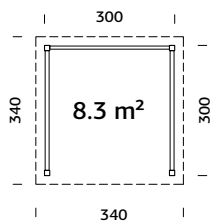

Lenna Set 302 8,3 m²



Su ordinazione

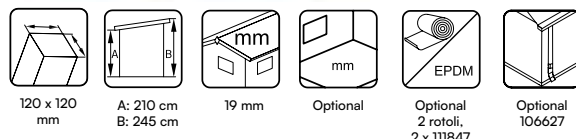
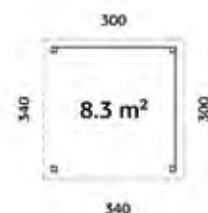

Lenna Set 303 8,3 m²



Su ordinazione

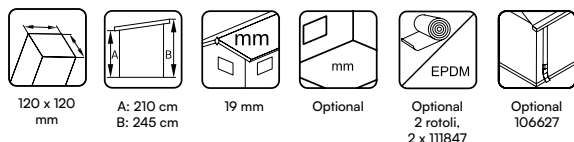
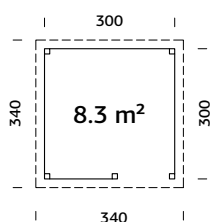

Lenna Set 307 16,6 m²



Su ordinazione

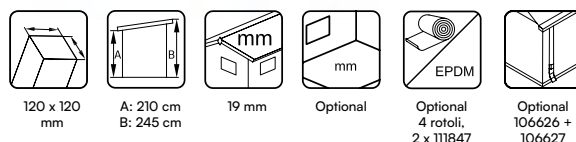
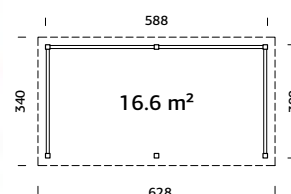

Lenna Set 309 16,6 m²



Su ordinazione

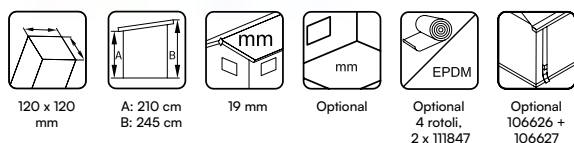
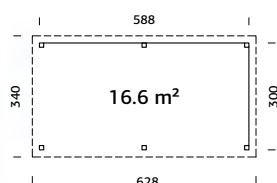

Lenna Set 308 16,6 m²



Su ordinazione

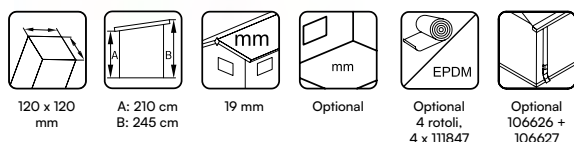
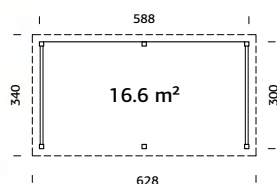

Lenna Set 310 16,6 m²



Su ordinazione

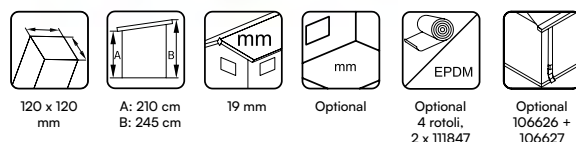
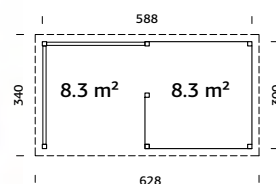



Maggiori
informazioni

18

STRUTTURE COMPONIBILI



Vedi colorazioni disponibili a pag. 133

Lenna 8,3 m²

Su ordinazione 

401 SCORREVOLI SINGOLO VETRO /
701 SCORREVOLI DOPPIO VETRO

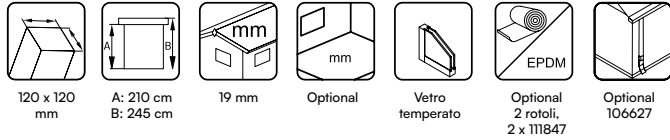
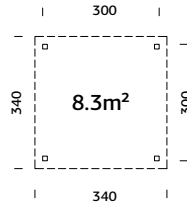

Lenna 16,6 m²

Su ordinazione 

402 SCORREVOLI SINGOLO VETRO /
702 SCORREVOLI DOPPIO VETRO

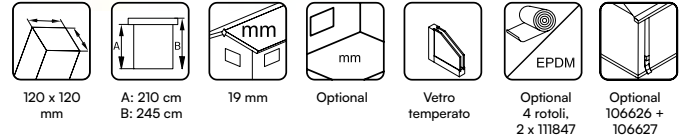
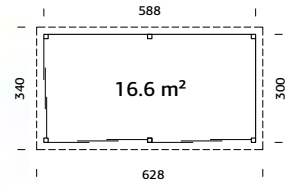

Lenna 16,6 m²

Su ordinazione 

403 SCORREVOLI SINGOLO VETRO /
703 SCORREVOLI DOPPIO VETRO

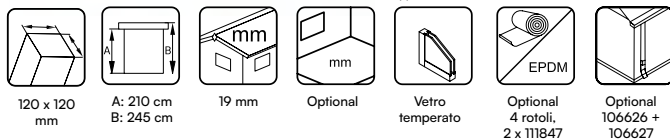
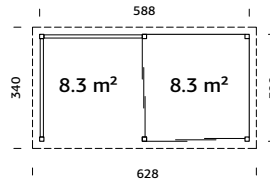

Lenna 16,6 m²

Su ordinazione 

404 SCORREVOLI SINGOLO VETRO /
704 SCORREVOLI DOPPIO VETRO

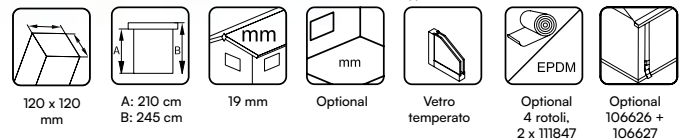
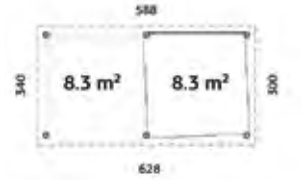

Lenna 16,6 m²

Su ordinazione 

405 SCORREVOLI SINGOLO VETRO /
705 SCORREVOLI DOPPIO VETRO

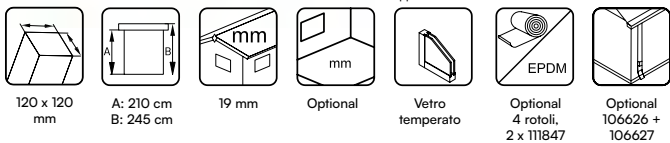
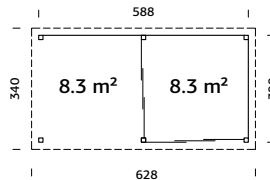

Lenna 16,6 m²

Su ordinazione 

406 SCORREVOLI SINGOLO VETRO /
706 SCORREVOLI DOPPIO VETRO

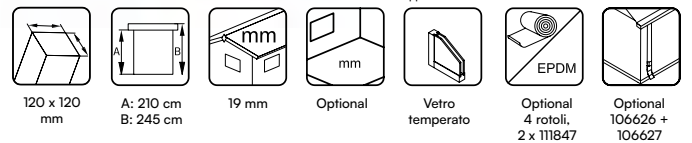
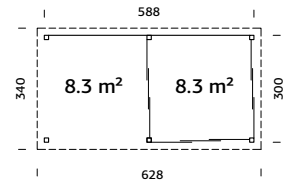

Lenna 16,6 m²

Su ordinazione 

407 SCORREVOLI SINGOLO VETRO /
707 SCORREVOLI DOPPIO VETRO

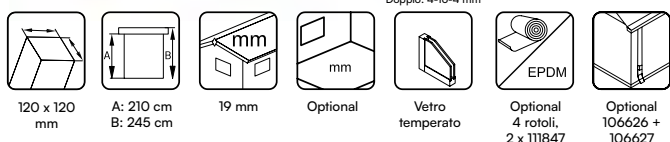
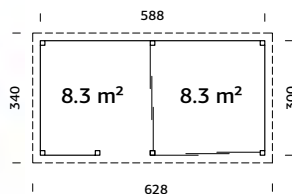

Lenna 16,6 m²

Su ordinazione 

408 SCORREVOLI SINGOLO VETRO /
708 SCORREVOLI DOPPIO VETRO

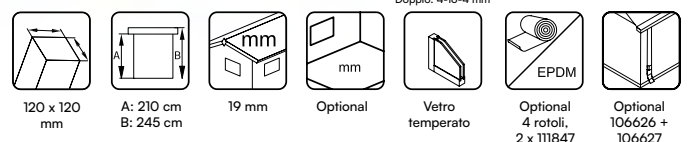
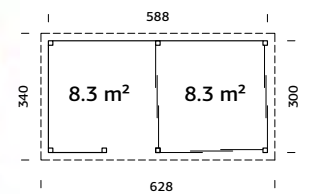

Lenna 24,9 m²

Su ordinazione

409 SCORREVOLI SINGOLO VETRO /
709 SCORREVOLI DOPPIO VETRO

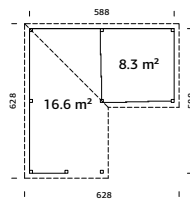

Singolo: 4 mm
Doppio: 4-16-4 mm

| | | | | | | |
|--------------|------------------------|-------|----------|-----------------|-------------------------------------|---------------------------------------|
| | | | | | | |
| 120 x 120 mm | A: 210 cm B: 245 cm | 19 mm | Optional | Vetro temperato | Optional 9 rotoli, 3 x 111847 | Optional 2 x 106626, 2 x 106627 |

Lenna 24,9 m²

Su ordinazione

410 SCORREVOLI SINGOLO VETRO /
710 SCORREVOLI DOPPIO VETRO

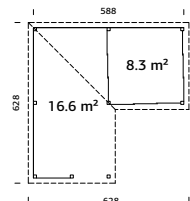

Singolo: 4 mm
Doppio: 4-16-4 mm

| | | | | | | |
|--------------|------------------------|-------|----------|-----------------|-------------------------------------|---------------------------------------|
| | | | | | | |
| 120 x 120 mm | A: 210 cm B: 245 cm | 19 mm | Optional | Vetro temperato | Optional 9 rotoli, 3 x 111847 | Optional 2 x 106626, 2 x 106627 |

Lenna 24,9 m²

Su ordinazione

412 SCORREVOLI SINGOLO VETRO /
712 SCORREVOLI DOPPIO VETRO

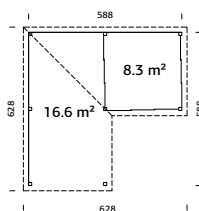

Singolo: 4 mm
Doppio: 4-16-4 mm

| | | | | | | |
|--------------|------------------------|-------|----------|-----------------|-------------------------------------|---------------------------------------|
| | | | | | | |
| 120 x 120 mm | A: 210 cm B: 245 cm | 19 mm | Optional | Vetro temperato | Optional 9 rotoli, 3 x 111847 | Optional 2 x 106626, 2 x 106627 |

Lenna 24,9 m²

Su ordinazione

422 SCORREVOLI SINGOLO VETRO /
722 SCORREVOLI DOPPIO VETRO

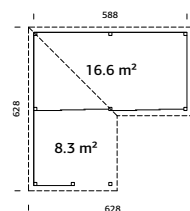

Singolo: 4 mm
Doppio: 4-16-4 mm

| | | | | | | |
|--------------|------------------------|-------|----------|-----------------|-------------------------------------|---------------------------------------|
| | | | | | | |
| 120 x 120 mm | A: 210 cm B: 245 cm | 19 mm | Optional | Vetro temperato | Optional 9 rotoli, 3 x 111847 | Optional 2 x 106626, 2 x 106627 |

Lenna 24,9 m²

Su ordinazione

423 SCORREVOLI SINGOLO VETRO /
723 SCORREVOLI DOPPIO VETRO

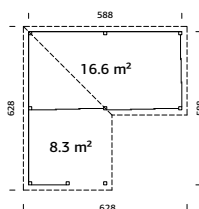

Singolo: 4 mm
Doppio: 4-16-4 mm

| | | | | | | |
|--------------|------------------------|-------|----------|-----------------|-------------------------------------|---------------------------------------|
| | | | | | | |
| 120 x 120 mm | A: 210 cm B: 245 cm | 19 mm | Optional | Vetro temperato | Optional 9 rotoli, 3 x 111847 | Optional 2 x 106626, 2 x 106627 |

Lenna 24,9 m²

Su ordinazione

411 SCORREVOLI SINGOLO VETRO /
711 SCORREVOLI DOPPIO VETRO

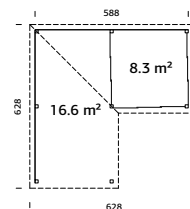

Singolo: 4 mm
Doppio: 4-16-4 mm

| | | | | | | |
|--------------|------------------------|-------|----------|-----------------|-------------------------------------|---------------------------------------|
| | | | | | | |
| 120 x 120 mm | A: 210 cm B: 245 cm | 19 mm | Optional | Vetro temperato | Optional 9 rotoli, 3 x 111847 | Optional 2 x 106626, 2 x 106627 |

Lenna 24,9 m²

Su ordinazione

413 SCORREVOLI SINGOLO VETRO /
713 SCORREVOLI DOPPIO VETRO

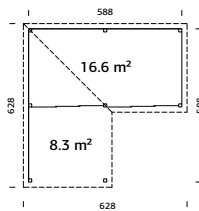

Singolo: 4 mm
Doppio: 4-16-4 mm

| | | | | | | |
|--------------|------------------------|-------|----------|-----------------|-------------------------------------|---------------------------------------|
| | | | | | | |
| 120 x 120 mm | A: 210 cm B: 245 cm | 19 mm | Optional | Vetro temperato | Optional 9 rotoli, 3 x 111847 | Optional 2 x 106626, 2 x 106627 |

Lenna 24,9 m²

Su ordinazione

414 SCORREVOLI SINGOLO VETRO /
714 SCORREVOLI DOPPIO VETRO

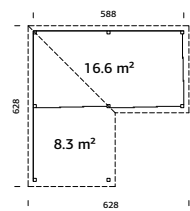

Singolo: 4 mm
Doppio: 4-16-4 mm

| | | | | | | |
|--------------|------------------------|-------|----------|-----------------|-------------------------------------|---------------------------------------|
| | | | | | | |
| 120 x 120 mm | A: 210 cm B: 245 cm | 19 mm | Optional | Vetro temperato | Optional 9 rotoli, 3 x 111847 | Optional 2 x 106626, 2 x 106627 |

Lenna 24,9 m²

Su ordinazione

415 SCORREVOLI SINGOLO VETRO /
715 SCORREVOLI DOPPIO VETRO

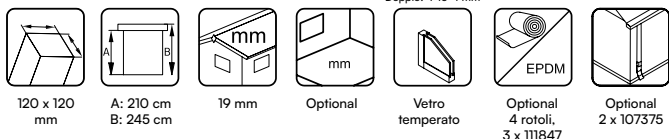
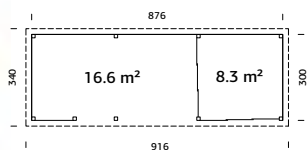

Lenna 24,9 m²

Su ordinazione

416 SCORREVOLI SINGOLO VETRO /
716 SCORREVOLI DOPPIO VETRO

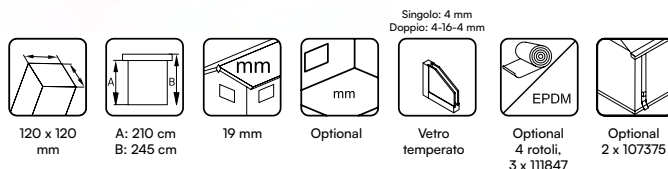
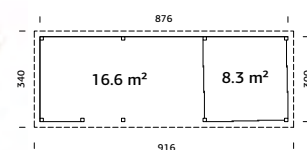

Lenna 24,9 m²

Su ordinazione

419 SCORREVOLI SINGOLO VETRO /
719 SCORREVOLI DOPPIO VETRO

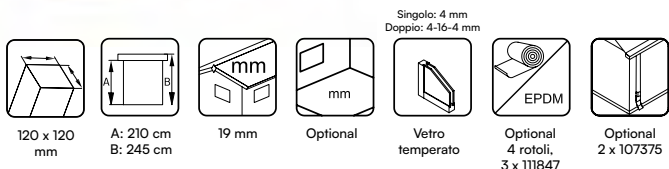
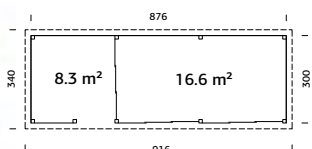

Lenna 24,9 m²

Su ordinazione

417 SCORREVOLI SINGOLO VETRO /
717 SCORREVOLI DOPPIO VETRO

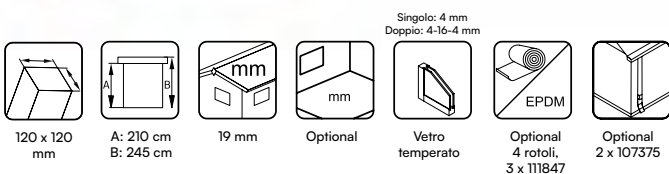
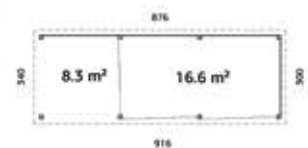

Lenna 24,9 m²

Su ordinazione

418 SCORREVOLI SINGOLO VETRO /
718 SCORREVOLI DOPPIO VETRO

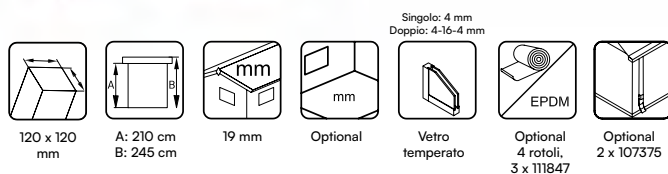
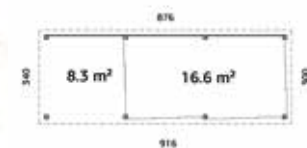

Lenna 33,2 m²

Su ordinazione

420 SCORREVOLI SINGOLO VETRO /
720 SCORREVOLI DOPPIO VETRO

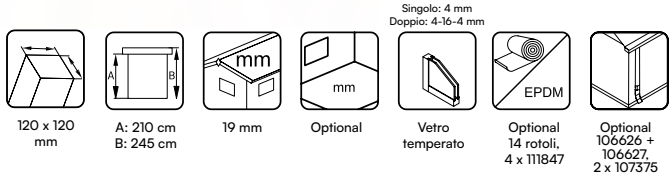
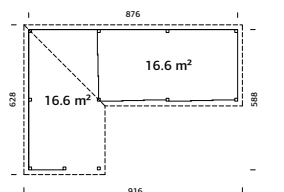

Lenna 33,2 m²

Su ordinazione

421 SCORREVOLI SINGOLO VETRO /
721 SCORREVOLI DOPPIO VETRO

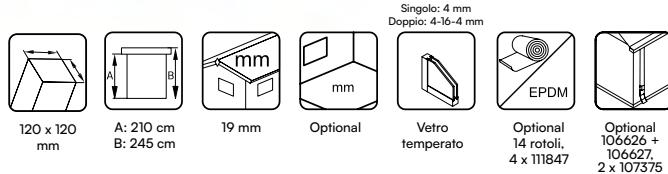
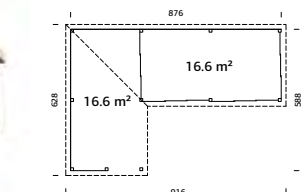

Bianca 8,3 m²

Su ordinazione

201 SCORREVOLI SINGOLO VETRO /
501 SCORREVOLI DOPPIO VETRO

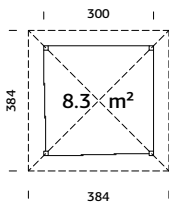

| | | | | | | |
|--------------|------------------------|-------|----------|-----------------|---------------------------------|---------------------|
| | | | | | | |
| 120 x 120 mm | A: 210 cm B: 319 cm | 19 mm | Optional | Vetro temperato | Optional 6 rotoli, 9 confezioni | Optional 2 x 106630 |

Bianca 16,6 m²

Su ordinazione

203 SCORREVOLI SINGOLO VETRO /
503 SCORREVOLI DOPPIO VETRO

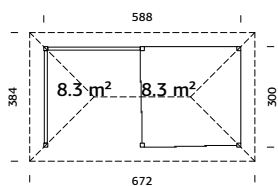

| | | | | | | |
|--------------|------------------------|-------|----------|-----------------|----------------------------------|------------------------------|
| | | | | | | |
| 120 x 120 mm | A: 210 cm B: 319 cm | 19 mm | Optional | Vetro temperato | Optional 9 rotoli, 14 confezioni | Optional 106629 + 2 x 106630 |

Bianca 16,6 m²

Su ordinazione

205 SCORREVOLI SINGOLO VETRO /
505 SCORREVOLI DOPPIO VETRO

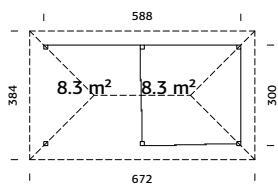

| | | | | | | |
|--------------|------------------------|-------|----------|-----------------|----------------------------------|------------------------------|
| | | | | | | |
| 120 x 120 mm | A: 210 cm B: 319 cm | 19 mm | Optional | Vetro temperato | Optional 9 rotoli, 14 confezioni | Optional 106629 + 2 x 106630 |

Bianca 16,6 m²

Su ordinazione

207 SCORREVOLI SINGOLO VETRO /
507 SCORREVOLI DOPPIO VETRO

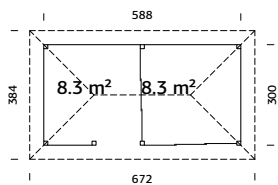

| | | | | | | |
|--------------|------------------------|-------|----------|-----------------|----------------------------------|------------------------------|
| | | | | | | |
| 120 x 120 mm | A: 210 cm B: 319 cm | 19 mm | Optional | Vetro temperato | Optional 9 rotoli, 14 confezioni | Optional 106629 + 2 x 106630 |

Bianca 16,6 m²

Su ordinazione

202 SCORREVOLI SINGOLO VETRO /
502 SCORREVOLI DOPPIO VETRO

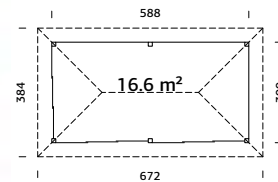

| | | | | | | |
|--------------|------------------------|-------|----------|-----------------|----------------------------------|------------------------------|
| | | | | | | |
| 120 x 120 mm | A: 210 cm B: 319 cm | 19 mm | Optional | Vetro temperato | Optional 9 rotoli, 14 confezioni | Optional 106629 + 2 x 106630 |

Bianca 16,6 m²

Su ordinazione

204 SCORREVOLI SINGOLO VETRO /
504 SCORREVOLI DOPPIO VETRO

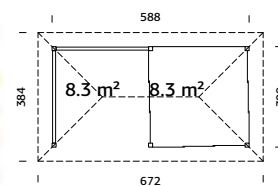

| | | | | | | |
|--------------|------------------------|-------|----------|-----------------|----------------------------------|------------------------------|
| | | | | | | |
| 120 x 120 mm | A: 210 cm B: 319 cm | 19 mm | Optional | Vetro temperato | Optional 9 rotoli, 14 confezioni | Optional 106629 + 2 x 106630 |

Bianca 16,6 m²

Su ordinazione

206 SCORREVOLI SINGOLO VETRO /
506 SCORREVOLI DOPPIO VETRO

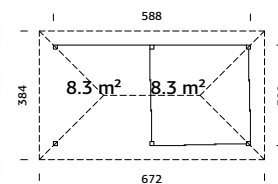

| | | | | | | |
|--------------|------------------------|-------|----------|-----------------|----------------------------------|------------------------------|
| | | | | | | |
| 120 x 120 mm | A: 210 cm B: 319 cm | 19 mm | Optional | Vetro temperato | Optional 9 rotoli, 14 confezioni | Optional 106629 + 2 x 106630 |

Bianca 16,6 m²

Su ordinazione

208 SCORREVOLI SINGOLO VETRO /
508 SCORREVOLI DOPPIO VETRO

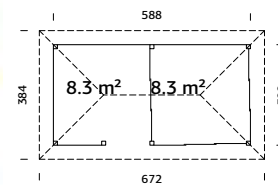

| | | | | | | |
|--------------|------------------------|-------|----------|-----------------|----------------------------------|------------------------------|
| | | | | | | |
| 120 x 120 mm | A: 210 cm B: 319 cm | 19 mm | Optional | Vetro temperato | Optional 9 rotoli, 14 confezioni | Optional 106629 + 2 x 106630 |

Bianca 24,9 m²

Su ordinazione 

209 SCORREVOLI SINGOLO VETRO /
509 SCORREVOLI DOPPIO VETRO

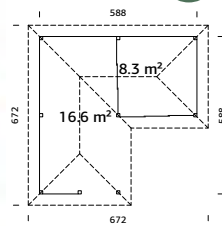

Singolo: 4 mm
Doppio: 4-16-4 mm

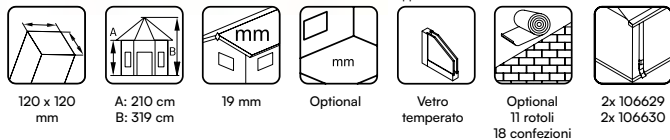

Bianca 24,9 m²

Su ordinazione 

210 SCORREVOLI SINGOLO VETRO /
510 SCORREVOLI DOPPIO VETRO

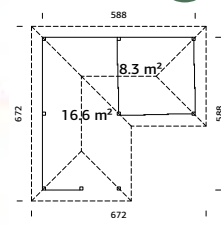

Singolo: 4 mm
Doppio: 4-16-4 mm

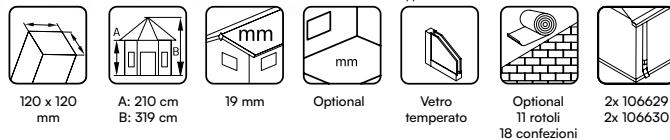

Bianca 24,9 m²

Su ordinazione 

212 SCORREVOLI SINGOLO VETRO /
512 SCORREVOLI DOPPIO VETRO

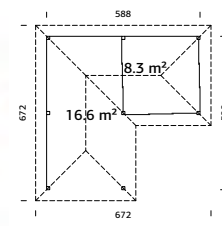

Singolo: 4 mm
Doppio: 4-16-4 mm

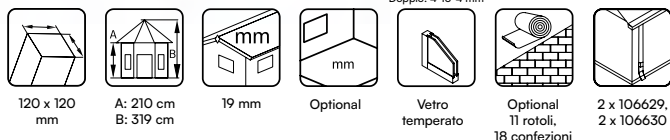

Bianca 24,9 m²

Su ordinazione 

222 SCORREVOLI SINGOLO VETRO /
522 SCORREVOLI DOPPIO VETRO

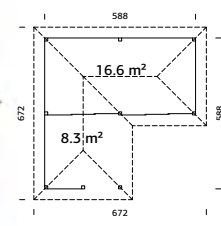

Singolo: 4 mm
Doppio: 4-16-4 mm

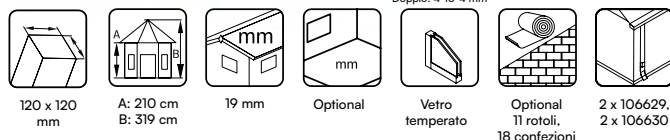

Bianca 24,9 m²

Su ordinazione 

223 SCORREVOLI SINGOLO VETRO /
523 SCORREVOLI DOPPIO VETRO

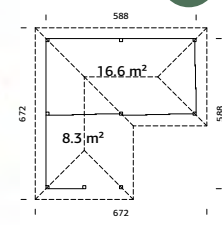

Singolo: 4 mm
Doppio: 4-16-4 mm

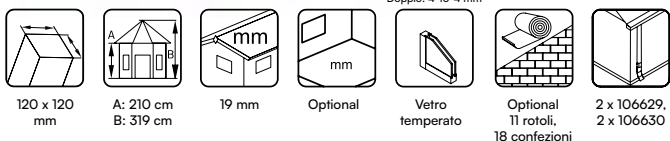

Bianca 24,9 m²

Su ordinazione 

211 SCORREVOLI SINGOLO VETRO /
511 SCORREVOLI DOPPIO VETRO

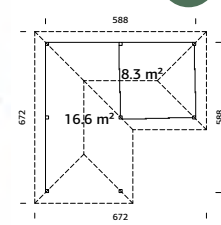

Singolo: 4 mm
Doppio: 4-16-4 mm

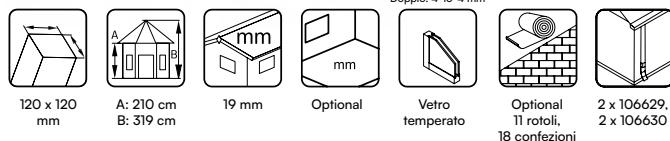

Bianca 24,9 m²

Su ordinazione 

213 SCORREVOLI SINGOLO VETRO /
513 SCORREVOLI DOPPIO VETRO

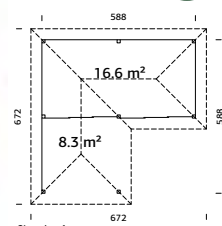

Singolo: 4 mm
Doppio: 4-16-4 mm

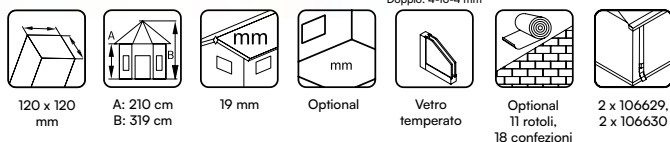

Bianca 24,9 m²

Su ordinazione 

214 SCORREVOLI SINGOLO VETRO /
514 SCORREVOLI DOPPIO VETRO

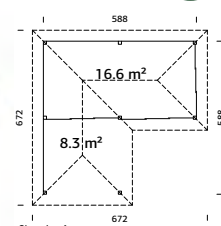

Singolo: 4 mm
Doppio: 4-16-4 mm

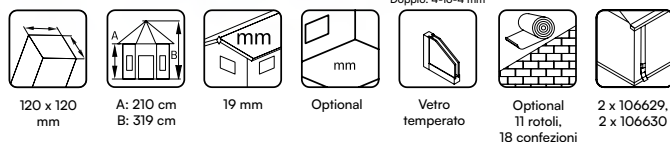

Bianca 24,9 m²

Su ordinazione

215 SCORREVOLI SINGOLO VETRO /
515 SCORREVOLI DOPPIO VETRO

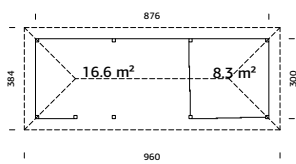

Singolo: 4 mm
Doppio: 4-16-4 mm

| | | | | | | |
|--------------|------------------------|-------|----------|-----------------|--|-----------------------|
| | | | | | | |
| 120 x 120 mm | A: 210 cm B: 319 cm | 19 mm | Optional | Vetro temperato | Optional 9 rotoli, 18 confezioni | 2 x 106630, 106632 |

Bianca 24,9 m²

Su ordinazione

216 SCORREVOLI SINGOLO VETRO /
516 SCORREVOLI DOPPIO VETRO

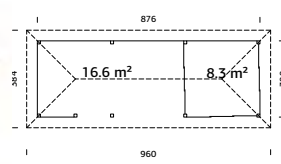

Singolo: 4 mm
Doppio: 4-16-4 mm

| | | | | | | |
|--------------|------------------------|-------|----------|-----------------|--|-----------------------|
| | | | | | | |
| 120 x 120 mm | A: 210 cm B: 319 cm | 19 mm | Optional | Vetro temperato | Optional 9 rotoli, 18 confezioni | 2 x 106630, 106632 |

Bianca 24,9 m²

Su ordinazione

219 SCORREVOLI SINGOLO VETRO /
519 SCORREVOLI DOPPIO VETRO

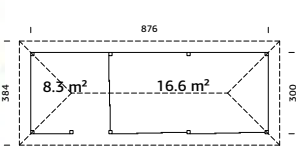

Singolo: 4 mm
Doppio: 4-16-4 mm

| | | | | | | |
|--------------|------------------------|-------|----------|-----------------|--|-----------------------|
| | | | | | | |
| 120 x 120 mm | A: 210 cm B: 319 cm | 19 mm | Optional | Vetro temperato | Optional 9 rotoli, 18 confezioni | 2 x 106630, 106632 |



Bianca 24,9 m²

Su ordinazione

217 SCORREVOLI SINGOLO VETRO /
517 SCORREVOLI DOPPIO VETRO

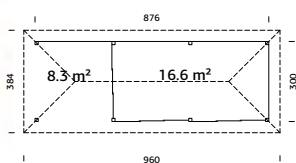

Singolo: 4 mm
Doppio: 4-16-4 mm

| | | | | | | |
|--------------|------------------------|-------|----------|-----------------|--|-----------------------|
| | | | | | | |
| 120 x 120 mm | A: 210 cm B: 319 cm | 19 mm | Optional | Vetro temperato | Optional 9 rotoli, 18 confezioni | 2 x 106630, 106632 |

Bianca 24,9 m²

Su ordinazione

218 SCORREVOLI SINGOLO VETRO /
518 SCORREVOLI DOPPIO VETRO

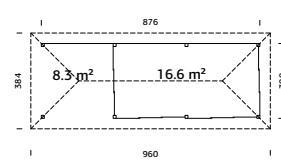

Singolo: 4 mm
Doppio: 4-16-4 mm

| | | | | | | |
|--------------|------------------------|-------|----------|-----------------|--|-----------------------|
| | | | | | | |
| 120 x 120 mm | A: 210 cm B: 319 cm | 19 mm | Optional | Vetro temperato | Optional 9 rotoli, 18 confezioni | 2 x 106630, 106632 |

Bianca 33,2 m²

Su ordinazione

220 SCORREVOLI SINGOLO VETRO /
520 SCORREVOLI DOPPIO VETRO

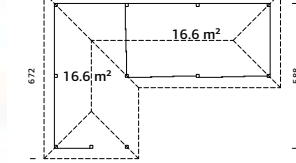

Singolo: 4 mm
Doppio: 4-16-4 mm

| | | | | | | |
|--------------|------------------------|-------|----------|-----------------|---|----------------------------------|
| | | | | | | |
| 120 x 120 mm | A: 210 cm B: 319 cm | 19 mm | Optional | Vetro temperato | Optional 14 rotoli, 25 confezioni | 106629, 2 x 106630, 106632 |

Bianca 33,2 m²

Su ordinazione

221 SCORREVOLI SINGOLO VETRO /
521 SCORREVOLI DOPPIO VETRO

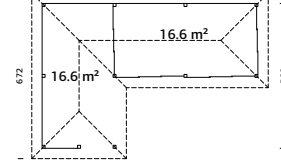

Singolo: 4 mm
Doppio: 4-16-4 mm

| | | | | | | |
|--------------|------------------------|-------|----------|-----------------|---|----------------------------------|
| | | | | | | |
| 120 x 120 mm | A: 210 cm B: 319 cm | 19 mm | Optional | Vetro temperato | Optional 14 rotoli, 25 confezioni | 106629, 2 x 106630, 106632 |

Lenna 8,3 m²



Su ordinazione

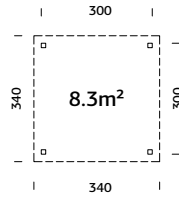

120 x 120 mm



A: 210 cm
B: 245 cm



19 mm



Optional



Optional
2 rotoli,
2 x 111847



Optional
106627

Bianca 8,3 m²



Su ordinazione

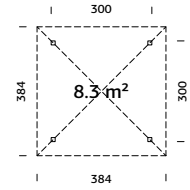

120 x 120 mm



A: 210 cm
B: 319 cm



19 mm



Optional



Optional
6 rotoli,
9 confezioni



Optional
2 x 106630

Lenna 16,6 m²



Su ordinazione

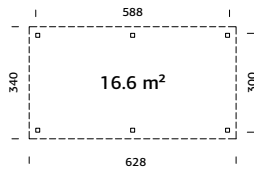

120 x 120 mm



A: 210 cm
B: 245 cm



19 mm



Optional



Optional
4 rotoli,
2 x 111847



Optional
106626 +
106627

Bianca 16,6 m²



Su ordinazione

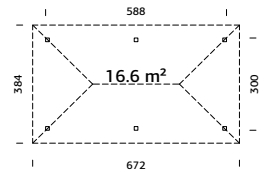

120 x 120 mm



A: 210 cm
B: 319 cm



19 mm



Optional



Optional
9 rotoli,
14 confezioni



Optional
106629 +
2 x 106630

Lenna 24,9 m²



Su ordinazione

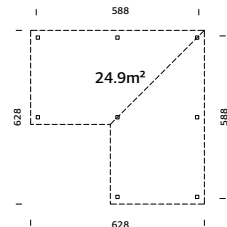

120 x 120 mm



A: 210 cm
B: 245 cm



19 mm



Optional



Optional
9 rotoli,
3 x 111847



Optional
2 x 106626,
2 x 106627

Bianca 24,9 m²



Su ordinazione

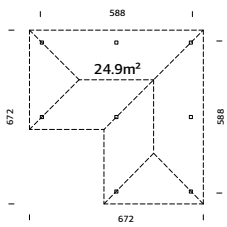

120 x 120 mm



A: 210 cm
B: 319 cm



19 mm



Optional



Optional
11 rotoli,
18 confezioni



Optional
2 x 106629,
2 x 106630



Maggiori
informazioni

19

SAUNE



Vedi colorazioni disponibili a pag. 133

Anette 3,0+1,5 m²

Su ordinazione 

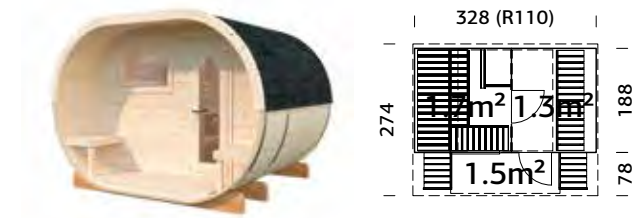

Riscaldatore optional



42 mm



A: 220 cm
B: 225 cm



Griglie del pavimento
28 mm

3-6-3 mm
8 mm
4-5-4 mm



Finestre con doppio vetro,
porte con doppio vetro
temperato



Incluso

334

Anita 0,9 m²

Su ordinazione 



Riscaldatore optional



42 mm



A: 200 cm
B: 206 cm



Griglie del pavimento
28 mm



Vetro
temperato



Incluso

Anita 1,3+0,7 m² CON PARETE IN VETRO

Su ordinazione 



Riscaldatore optional



42 mm



A: 220 cm
B: 225 cm



Griglie del pavimento
28 mm



Vetro
temperato



Incluso

Anita 1,6+0,7 m² CON PARETE IN VETRO

Su ordinazione 



Riscaldatore optional



42 mm



A: 220 cm
B: 225 cm



Griglie del pavimento
28 mm



Vetro
temperato



Incluso

Sanna 4,1+5,9 m²

Su ordinazione 

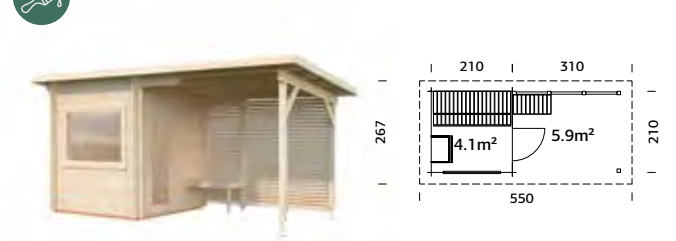

Riscaldatore optional



44 mm



A: 217 cm
B: 249 cm



Incluso
Tetto: 19 mm
Pavimento: 28 mm



Vetro
temperato



Optional
4 rotoli,
2 x 111847



Optional
106628

Sanna 4,1 m²

Su ordinazione 



Riscaldatore optional



44 mm



A: 217 cm
B: 249 cm



Incluso
Tetto: 19 mm
Pavimento: 28 mm



Vetro
temperato



Optional
2 rotoli,
111847



Optional
106627

Sanna 6,8m²

Su ordinazione 

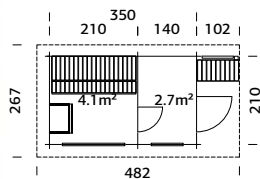

Riscaldatore optional



44 mm



A: 217 cm
B: 249 cm



Incluso
Tetto: 19 mm
Pavimento: 28 mm

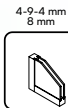

Vetro temperato



Optional
2 rotoli,
2 x 111847



Optional
107375

Sanna 6,8+5,9m²

Su ordinazione 

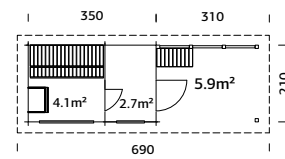

Riscaldatore optional



44 mm



A: 217 cm
B: 249 cm



Incluso
Tetto: 19 mm
Pavimento: 28 mm

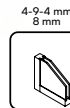

Vetro temperato



Optional
4 rotoli,
2 x 111847



Optional
106626 +
106627

Sanna 11,5m²

Su ordinazione 

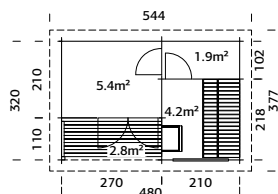

Riscaldatore optional



44 mm



A: 217 cm
B: 261 cm



Incluso
Tetto: 19 mm
Pavimento: 28 mm



Vetro temperato



Optional
5 rotoli,
2 x 111847



Optional
106628

Sanna 12,8m² SCORREVOLI VETRO SINGOLO / DOPPIO VETRO

Su ordinazione 

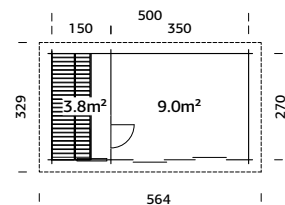

Riscaldatore optional



44 mm



A: 211 cm
B: 239 cm



Incluso
Tetto: 19 mm
Pavimento: 28 mm



Vetro temperato



Optional
4 rotoli,
2 x 111847

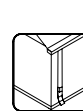

Optional
106628

Grace sauna 5,3m²

Su ordinazione 

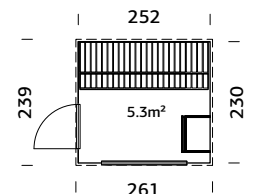

Riscaldatore optional



56 mm



A: 245 cm
B: 249 cm



Tetto: 19 mm
Pavimento: 28 mm



Doppio
vetro
temperato



Optional
1 rotolo,
111847



Optional
106626

Grace sauna 8,2m²

Su ordinazione 

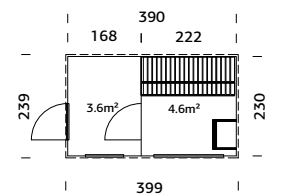

Riscaldatore optional



56 mm



A: 245 cm
B: 250 cm



Tetto: 19 mm
Pavimento: 28 mm



Doppio
vetro
temperato



Optional
2 rotoli,
111847



Optional
106627

Sarah 3,8+2,1m²

Su ordinazione 

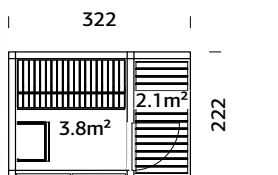

Riscaldatore optional



16 + 70 mm



A: 222 cm
B: 237 cm



Incluso
Tetto: 16 mm
Pavimento: 28 mm



Doppio
vetro
temperato



Optional
2 rotoli,
111847



Optional
106627



Le nostre saune sono progettate per il riscaldamento tramite stufe elettriche, che offriamo come prodotti opzionali.

Le stufe elettriche consentono un rapido riscaldamento della sauna, permettono un controllo preciso della temperatura e ne facilitano la regolazione.

La tabella sottostante mostra la corrispondenza tra ciascun modello di sauna e la relativa stufa elettrica compatibile, indicando quale stufa può essere installata sui diversi modelli di sauna.

Impianto elettrico escluso.

| NUMERO SAUNA | MODELLO SAUNA |  |  |  |  |
|--------------|---|---|--|---|---|
| | | NARVI MINEX 3,6 KW Articolo nr. 121441 | NARVI NM 6 KW Articolo nr. 110115 | NARVI NM 9 KW Articolo nr. 121526 | HUUM DROP Articolo nr. 110119 |
| 110343 | Anita 0,9 m ² | ✓ | | | |
| 110070 | Anita 1,3 + 0,7 m ² | | ✓ | | ✓ |
| 111005 | Anita 1,3 + 0,7 m ² con parete di vetro | | ✓ | | ✓ |
| 111003 | Anita 1,6 + 0,7 m ² | | ✓ | ✓ | ✓ |
| 111004 | Anita 1,6 + 0,7 m ² con parete di vetro | | ✓ | ✓ | ✓ |
| 110071 | Anette 3,0 + 1,5 m ² | | ✓ | | ✓ |
| 110741 | Sanna 4,1 m ² | | ✓ | ✓ | ✓ |
| 111001 | Sanna 4,1 + 5,9 m ² | | ✓ | ✓ | ✓ |
| 110526 | Sanna 6,8 m ² | | ✓ | ✓ | ✓ |
| 111002 | Sanna 6,8 + 5,9 m ² | | ✓ | ✓ | ✓ |
| 119349 | Sanna 11,5 m ² | | ✓ | ✓ | ✓ |
| 111000 | Sanna 12,8 m ² Slide | | ✓ | ✓ | ✓ |
| 111239 | Sanna 12,8 m ² Slide Plus | | ✓ | ✓ | ✓ |
| 119360 | Grace Sauna 5,3 m ² | | ✓ | ✓ | ✓ |
| 112125 | Grace Sauna 8,2 m ² | | ✓ | ✓ | ✓ |
| 120033 | Sarah 3,8+2,1 m ² | | ✓ | ✓ | ✓ |



Maggiori
informazioni

20

PORTATTREZZI

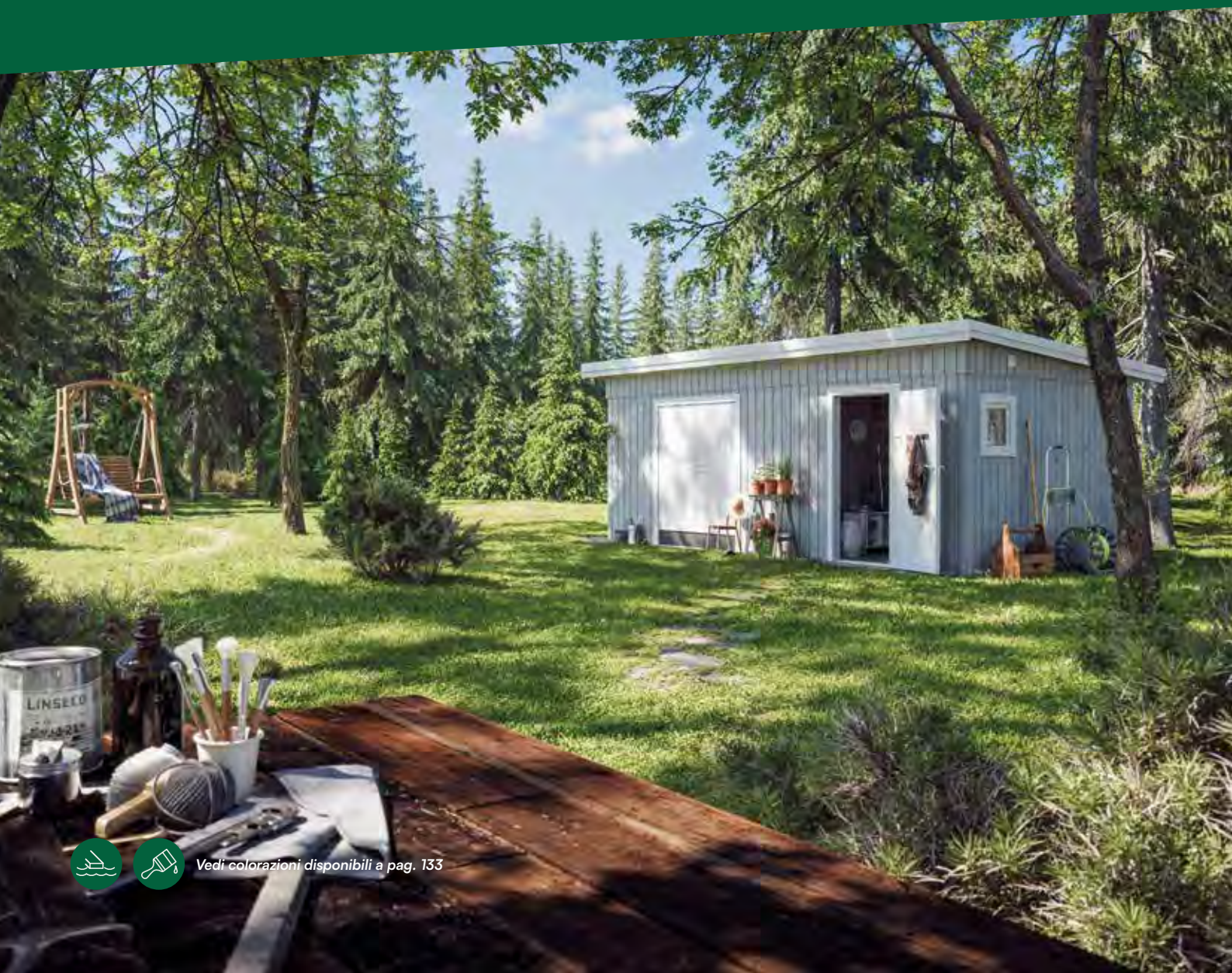

Vedi colorazioni disponibili a pag. 133

Leif 2.2 m²



Su ordinazione

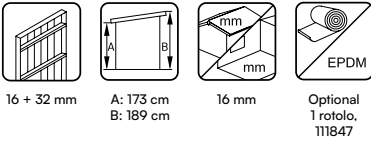
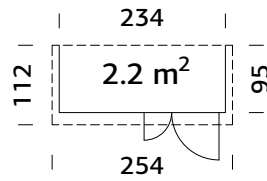

Leif 3.0 m²



Su ordinazione

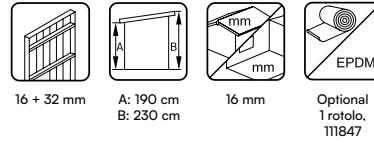
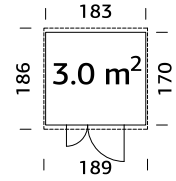

Leif 4.5 m²



Su ordinazione

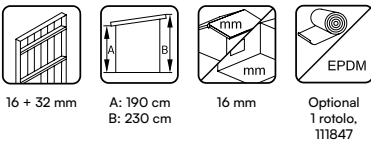
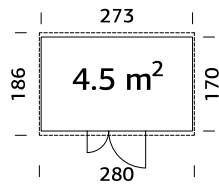

Leif 3.0+2.9 m²



Su ordinazione

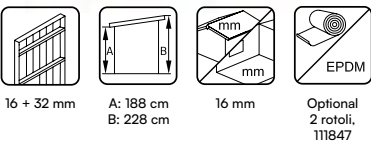
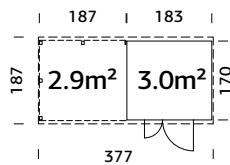

Leif 4.5+2.9 m²



Su ordinazione

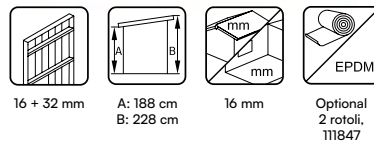
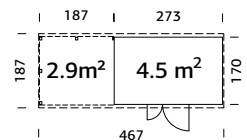

Mia 3.6 m²



Su ordinazione

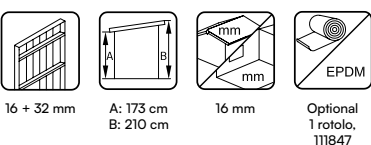
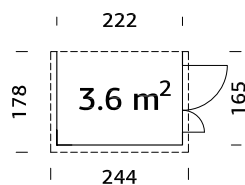

Mia 5.4 m²



Su ordinazione

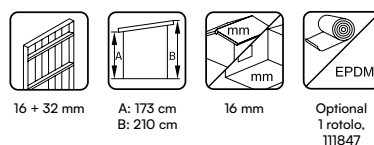
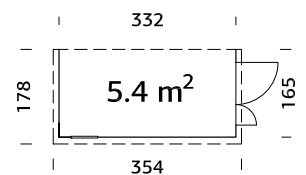

Elias 4,9 m²



Su ordinazione

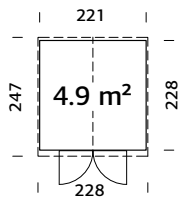

16 + 32 mm



A: 191 cm
B: 220 cm



16 mm



Plexiglass



EPDM



Optional
106626

Optional
1 rotolo,
111847

Elias 7,3 m²



Su ordinazione

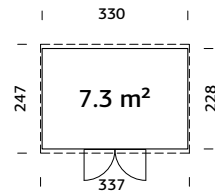

16 + 32 mm



A: 190 cm
B: 220 cm



16 mm



Plexiglass



EPDM



Optional
106627

Optional
2 rotoli,
111847

Nils 5,4 m²



Su ordinazione

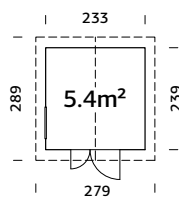

16 + 32 mm



A: 188 cm
B: 238 cm



Includo
16 mm



Plexiglass



Option
2 rotoli,
4 confezioni



Optional
106629

Nils 8,2 m²



Su ordinazione

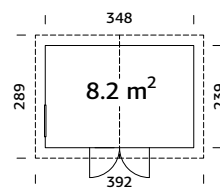

16 + 32 mm



A: 188 cm
B: 238 cm



Includo
16 mm



Plexiglass



Option
2 rotoli,
5 confezioni



Optional
106629



Lucas 12,1 m²



Su ordinazione

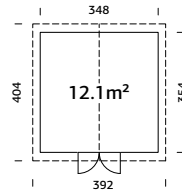

16 + 32 mm



A: 188 cm
B: 259 cm



16 mm



Vetro



Option
3 rotoli,
7 confezioni



Optional
106630

Stig 8,2 m²



Su ordinazione

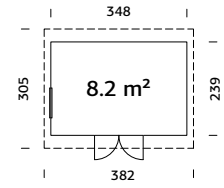

16 + 32 mm



A: 205 cm
B: 250 cm



Incluso
16 mm



Vetro



Option
2 rotoli,
2 x 11847



Optional
106627

Jari 8,9 m²



Su ordinazione

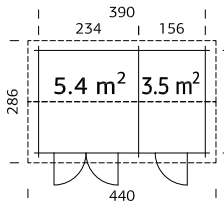

28 mm



A: 211 cm
B: 249 cm



19 mm



Option
2 rotoli,
6 confezioni



Optional
106631

Jari 14,5 m²



Su ordinazione

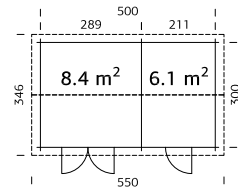

28 mm



A: 211 cm
B: 249 cm



19 mm



Option
5 rotoli
8 confezioni



Optional
106632

Chick 6,7 m²

Su ordinazione

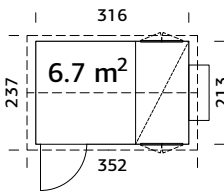

16 + 32 mm



A: 206 cm
B: 283 cm



Plexiglass



-



Martin 8,4 m²

Su ordinazione

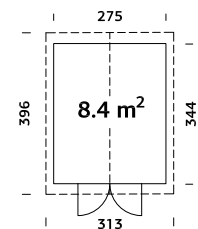

18 + 70 mm



A: 209 cm
B: 267 cm



19 mm



Option
2 rotoli,
6 confezioni



Optional
106630

Martin 13,6 m²

Su ordinazione

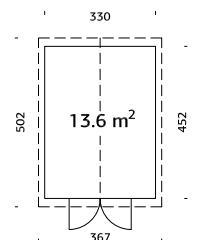

18 + 70 mm



A: 203 cm
B: 296 cm



19 mm



Option
5 rotoli,
8 confezioni



Optional
106632

Kalle 6,6 m²

Su ordinazione 

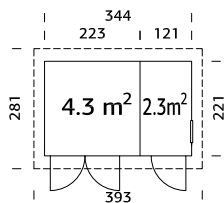

18 + 70 mm



A: 209 cm
B: 249 cm



19 mm



4-9-4 mm
Doppio
vetro
temperato



Optional
2 rotoli,
2 x 111847



Optional
106627

Kalle 13,5 m²

Su ordinazione 

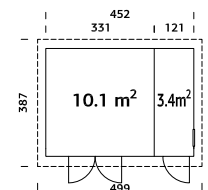

18 + 70 mm



A: 209 cm
B: 259 cm



19 mm



4-9-4 mm
Doppio
vetro
temperato



Optional
3 rotoli,
2 x 111874



Optional
106628

Kalle 16,9 m²

Su ordinazione 

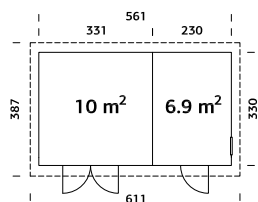

18 + 70 mm



A: 210 cm
B: 259 cm



19 mm



4-9-4 mm
Doppio
vetro
temperato



Optional
5 rotoli,
2 x 111874



Optional
106626 +
106627



Olaf 13,5 m²

Su ordinazione 

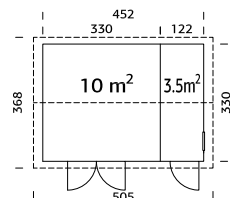

18 + 70 mm



A: 209 cm
B: 261 cm



19 mm



4-9-4 mm
Doppio
vetro
temperato



Optional
3 rotoli,
8 confezioni



Optional
106632

Olaf 16,9 m²

Su ordinazione 

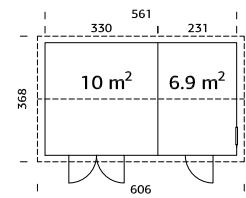

18 + 70 mm



A: 210 cm
B: 261 cm



19 mm



4-9-4 mm
Doppio
vetro
temperato



Optional
5 rotoli,
8 confezioni



Optional
106629 +
106630



Maggiori
informazioni

21

GARAGE E CARPORT



Vedi colorazioni disponibili a pag. 133

Karl 23,1m²



Su ordinazione

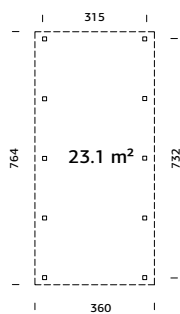

120 x 120 mm



A: 212 cm
B: 230 cm



19 mm



Optional
6 rotoli,
3 x 111847



Optional
106627

Karl 40,6 m²



Su ordinazione

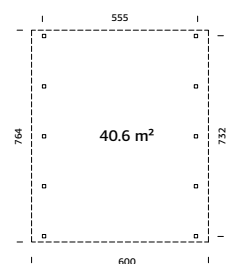

120 x 120 mm



A: 216 cm
B: 244 cm



19 mm



Optional
7 rotoli,
3 x 111847



Optional
106628

Karl 23,1m² CON CASETTA



Su ordinazione

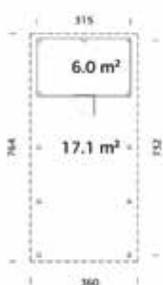

120 x 120 mm



A: 213 cm
B: 235 cm



19 mm



Optional
6 rotoli,
3 x 111847



Optional
106627

Karl 40,6 m² CON CASETTA



Su ordinazione

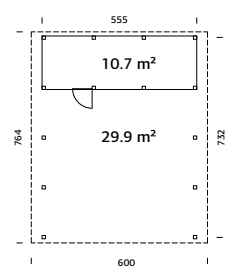

120 x 120 mm



A: 226 cm
B: 254 cm



19 mm



Optional
8 rotoli,
4 x 111847



Optional
106628



Robert 11,7 m²



Su ordinazione

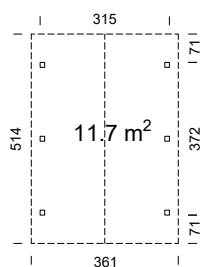

120 x 120 mm



A: 215 cm
B: 301 cm



19 mm



Optional
5 rotoli,
8 confezioni



Optional
106632

Robert 23,1 m²



Su ordinazione

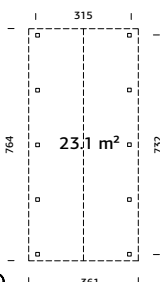

120 x 120 mm



A: 215 cm
B: 301 cm



19 mm



Optional
5 rotoli,
12 confezioni



Optional
2 x 106630

Robert 23,1 m² CON CASSETTA



Su ordinazione

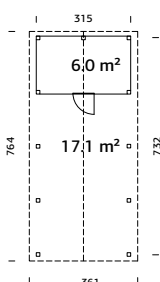

120 x 120 mm



A: 215 cm
B: 301 cm



19 mm



Optional
5 rotoli,
12 confezioni



Optional
2 x 106630

Rasmus 19,0 m² KIT



Su ordinazione

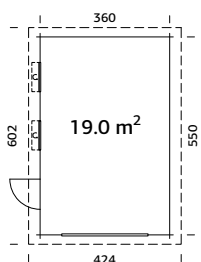

44 mm



A: 228 cm
B: 254 cm



19 mm



Vetro



Optional
6 rotoli,
2 x 111847



Optional
106628

Robert 20,6 m²



Su ordinazione

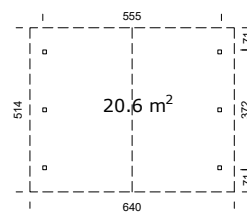

120 x 120 mm



A: 221 cm
B: 361 cm



19 mm



Optional
9 rotoli,
14 confezioni



Optional
106632

Robert 40,6 m²



Su ordinazione

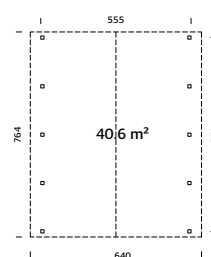

120 x 120 mm



A: 218 cm
B: 363 cm



19 mm



Optional
8 rotoli,
20 confezioni



Optional
2 x 106630

Robert 40,6 m² CON CASSETTA



Su ordinazione

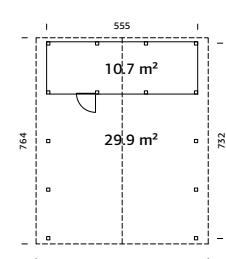

120 x 120 mm



A: 218 cm
B: 363 cm



19 mm



Optional
8 rotoli,
20 confezioni



Optional
2 x 106630

Rasmus 19,0 m² CON PORTONE IN LEGNO



Su ordinazione

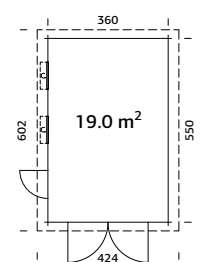

44 mm



A: 228 cm
B: 254 cm



19 mm



Vetro



Optional
6 rotoli,
2 x 111847



Optional
106628

Rasmus 19,0 m² CON PORTONE SEZIONALE

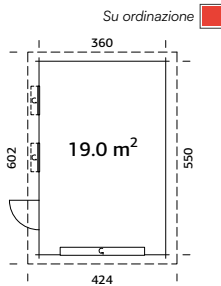

Motore optional



44 mm



A: 228 cm
B: 254 cm



19 mm



Vetro



Optional
6 rotoli,
2 x 111847



Optional
106628

Roger 21,9+5,2 m² KIT

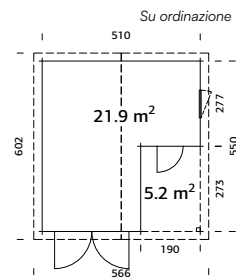

44 mm



A: 228 cm
B: 321 cm



19 mm



Doppio
vetro



Optional
7 rotoli, 14
confezioni



Optional
106632

Roger 21,9+5,2 m² CON PORTONE IN LEGNO

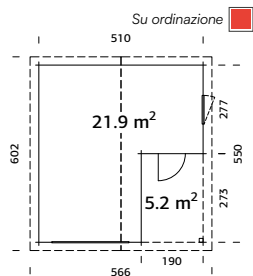

44 mm



A: 228 cm
B: 321 cm



19 mm



Doppio
vetro



Optional
7 rotoli,
14 confezioni



Optional
106632

Roger 21,9+5,2 m² CON PORTONE SEZIONALE



Motore optional



44 mm



A: 228 cm
B: 321 cm



19 mm



Doppio
vetro



Optional
7 rotoli,
14 confezioni



Optional
106632

Roger 19,0 m² KIT

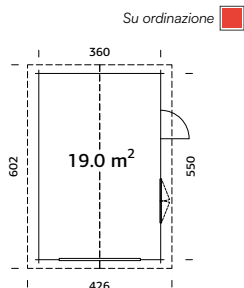

44 mm



A: 217 cm
B: 276 cm



19 mm



Doppio
vetro



Optional
6 rotoli,
10 confezioni



Optional
106632

Roger 19,0 m² CON PORTONE IN LEGNO

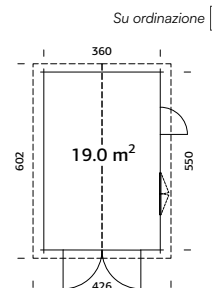

44 mm



A: 217 cm
B: 276 cm



19 mm



Doppio
vetro



Optional
6 rotoli,
10 confezioni



Optional
106632

Roger 19,0 m² CON PORTONE SEZIONALE



Motore optional



44 mm



A: 217 cm
B: 276 cm



19 mm



Doppio
vetro



Optional
6 rotoli,
10 confezioni



Optional
106632

Roger 23,9 m² KIT

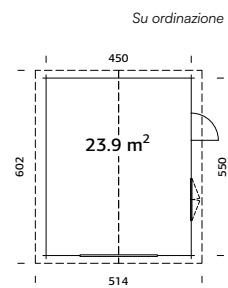

44 mm



A: 217 cm
B: 287 cm



19 mm



Doppio
vetro



Optional
7 rotoli,
12 confezioni



Optional
106632

Roger 23,9 m² CON PORTONE IN LEGNO

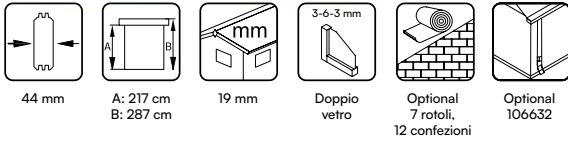
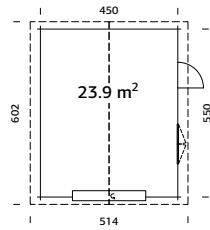

Roger 23,9 m² CON PORTONE SEZIONALE

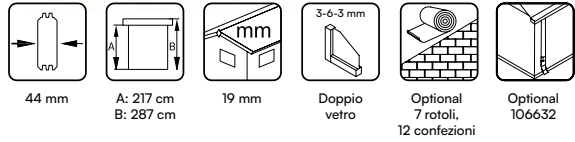
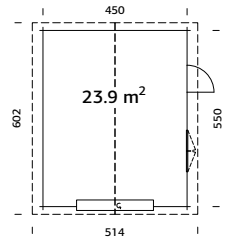

Roger 27,7 m² KIT

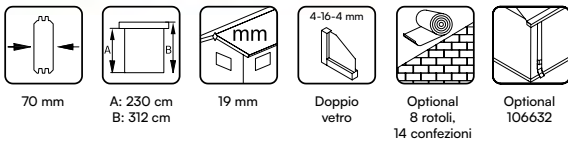
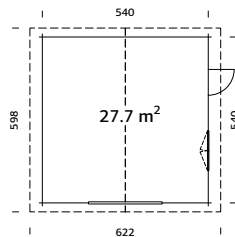

Roger 27,7 m² CON PORTONE IN LEGNO

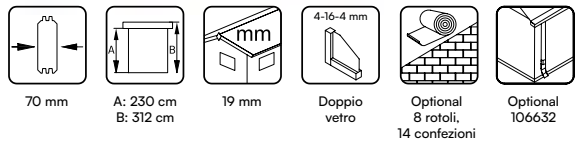
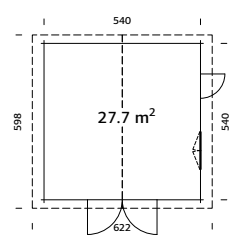

Roger 27,7 m² CON PORTONE SEZIONALE

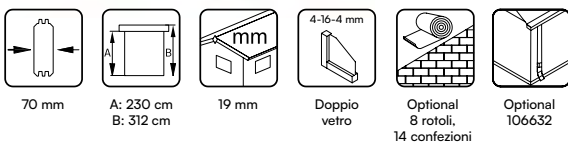
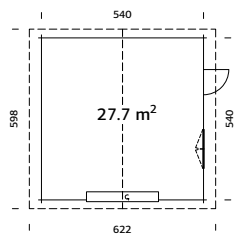

Roger 28,4 m² KIT

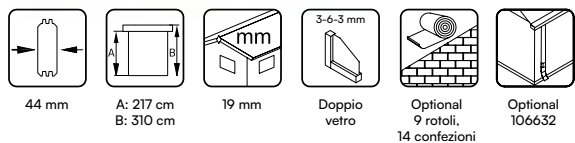
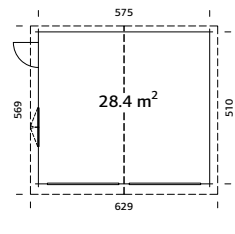

Roger 28,4 m² CON PORTONE IN LEGNO

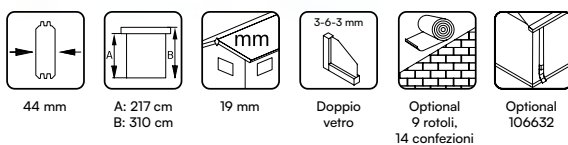
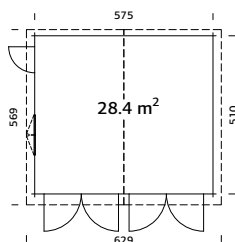

Roger 28,4 m² CON PORTONE SEZIONALE

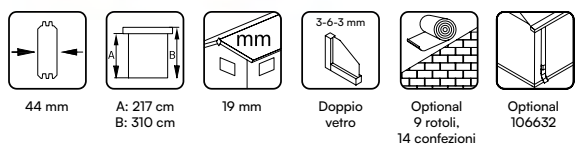
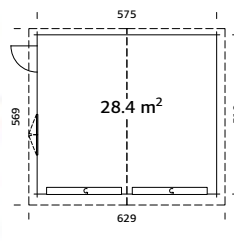

Roger 19,0+16,2 m² KIT



Su ordinazione

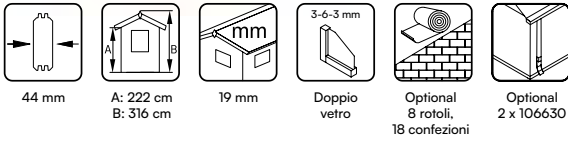
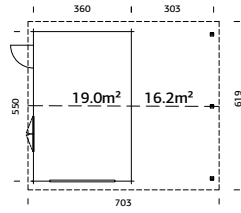

Roger 19,0+16,2 m² CON PORTONE IN LEGNO



Su ordinazione

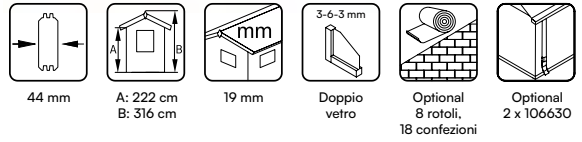
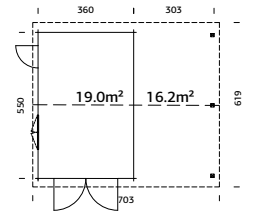

Roger 19,0+16,2 m² CON PORTONE SEZIONALE



Su ordinazione

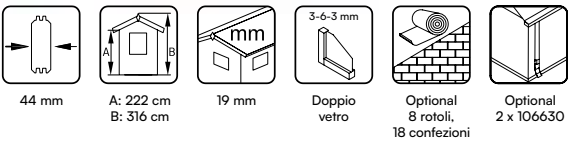
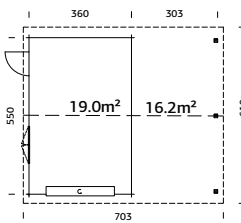

Roger 19,0+33,2 m² KIT



Su ordinazione

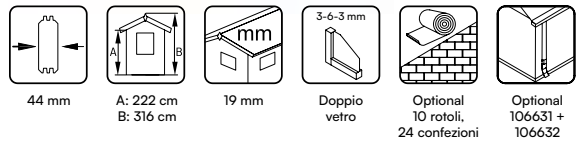
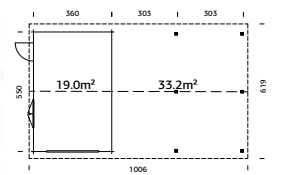

Roger 19,0+33,2 m² CON PORTONE IN LEGNO



Su ordinazione

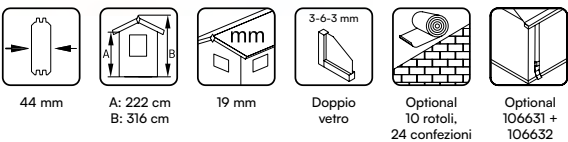
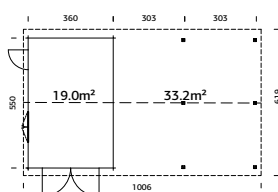

Roger 19,0+33,2 m² CON PORTONE SEZIONALE



Su ordinazione

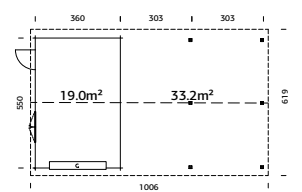
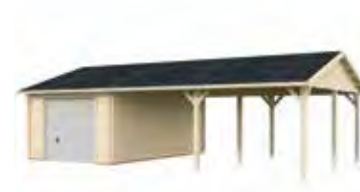

Motore optional

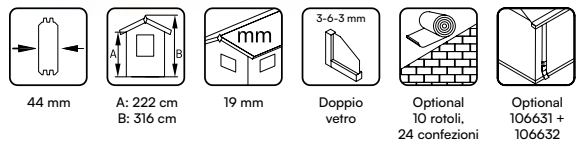

Andre 28,5 m² KIT

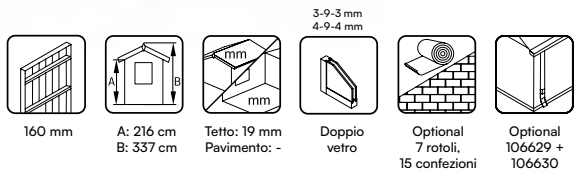

Andre 28,5 m² CON PORTONE SEZIONALE

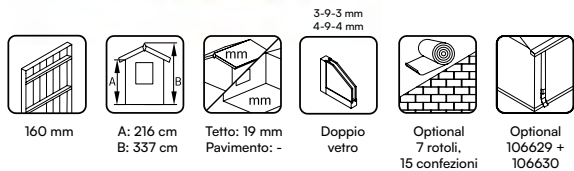

Andre 44,7 m² KIT

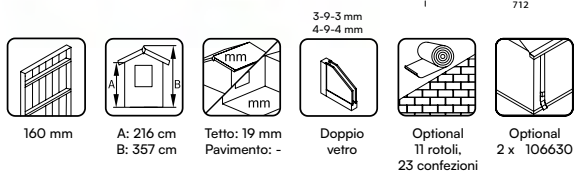

Andre 44,7 m² CON PORTONE SEZIONALE

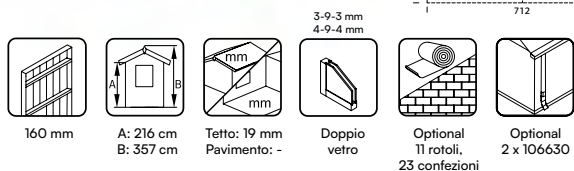



Maggiori
informazioni

22

GIOCHI PER BAMBINI



Jennie 3,6 m²

Su ordinazione 

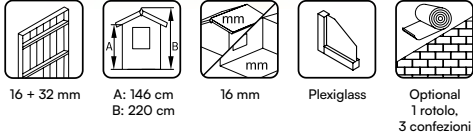
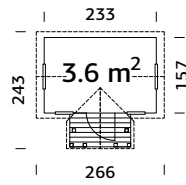

Marie 5,4 m²

Su ordinazione 

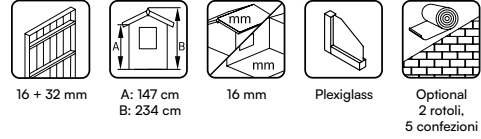
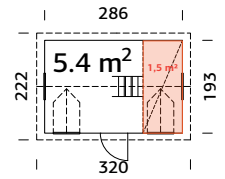

Grete 3,7 m²

Su ordinazione 

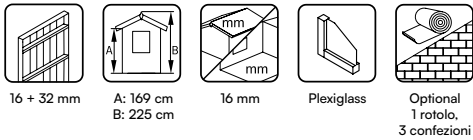
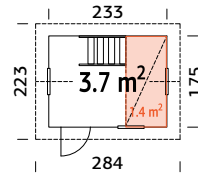

Stina 3,1 m²

Su ordinazione 

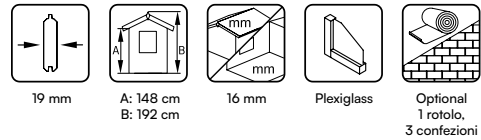
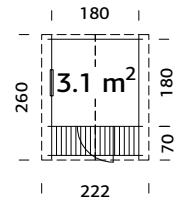

Huck 3,3 m²

Su ordinazione 

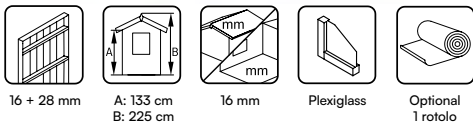
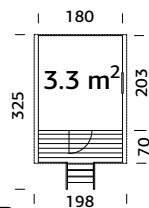

Magnus

Su ordinazione 

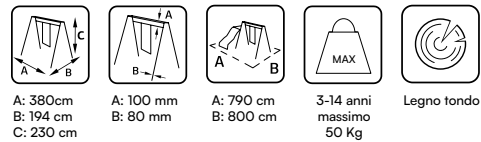

Holger

Su ordinazione 

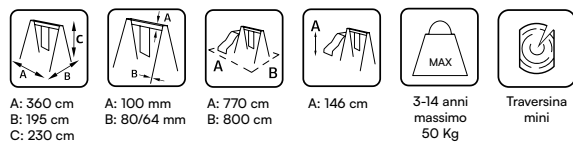

Henry

Su ordinazione 

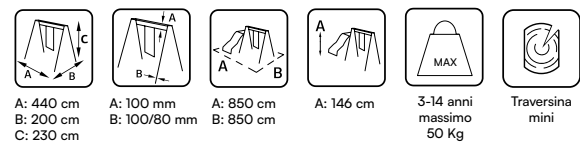

Brenda

Su ordinazione 



A: 510 cm
B: 195 cm
C: 230 cm



A: 100 mm
B: 80/64 mm



A: 920 cm
B: 880 cm



A: 146 cm



3-14 anni
massimo
50 Kg



Traversina
mini

Kalev

Su ordinazione 



A: 470 cm
B: 200 cm
C: 230 cm



A: 100 mm
B: 100/80 mm



A: 870 cm
B: 880 cm



A: 146 cm



3-14 anni
massimo
50 Kg



Traversina
mini

Merit

Su ordinazione 



A: 352 cm
B: 204 cm
C: 220 cm



A: 100 mm
B: 100 mm



A: 852 cm
B: 894 cm



3-14 anni
massimo
50 Kg



Legno tondo

Sandy 14 / 16

Su ordinazione 



A: 137 cm / 157 cm
B: 137 cm / 157 cm
C: 21 cm



3-14 anni
massimo
50 Kg



Tavole

Bosse

Su ordinazione 



A: 445 cm
B: 200 cm
C: 230 cm



A: 100 mm
B: 100/80 mm



A: 850 cm
B: 880 cm



A: 146 cm



3-14 anni
massimo
50 Kg



Traversina
mini

Kasper

Su ordinazione 



A: 366 cm
B: 200 cm
C: 230 cm



A: 100 mm
B: 100/80 mm



A: 880 cm
B: 770 cm



A: 146 cm



3-14 anni
massimo
50 Kg



Traversina
mini

Jonas

Su ordinazione 



A: 306 cm
B: 210 cm
C: 219 cm



A: 90 x 90 mm
B: 70 x 70 mm



A: 706 cm
B: 700 cm



A: 120 cm



3-14 anni
massimo
50 Kg



Legno
quadrato

Lisbet

Su ordinazione 



A: 90 cm
B: 89 cm
C: 50 cm



3-14 anni
massimo
50 Kg



Tavole

Jesper Torretta

Su ordinazione 

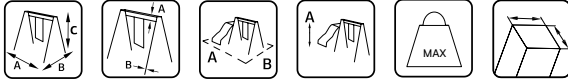

A: 120 cm
B: 120 cm
C: 314 cm
B: 70 x 70 mm
A: 520 cm
B: 605 cm
A: 120 cm
3-14 anni massimo 50 kg
Legno quadrato

Jesper Altalena

Su ordinazione 

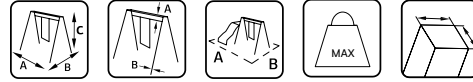

A: 241 cm
B: 208 cm
C: 214 cm
A: 90 x 90 mm
B: 70 x 70 mm
A: 445 cm
B: 700 cm
3-14 anni massimo 50 kg
Legno quadrato

Jesper Arrampicata

Su ordinazione 



A: 102 cm
B: 11 cm
C: 138 cm
3-14 anni massimo 50 kg
Legno quadrato

Jesper Ponte

Su ordinazione 



A: 235 cm
B: 116 cm
C: 89 cm
3-14 anni massimo 50 kg
Legno quadrato

Jesper set 1

2 torri con tetto + ponte+ parete da arrampicata + trave oscillante

Su ordinazione 



Lo scivolo è un optional

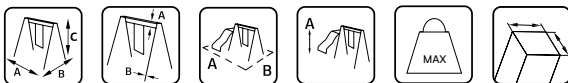

A: 600 cm
B: 464 cm
C: 314 cm
A: 90 x 90 mm
B: 70 x 70 mm
A: 1000 cm
B: 865 cm
A: 120 cm
3-14 anni massimo 50 kg
Legno quadrato

Jesper set 2

Torri con tetto + trave oscillante

Su ordinazione 

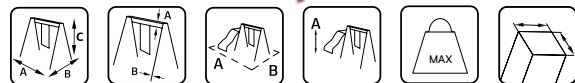

A: 366 cm
B: 305 cm
C: 314 cm
A: 90 x 90 mm
B: 70 x 70 mm
A: 766 cm
B: 866 cm
A: 120 cm
3-14 anni massimo 50 kg
Legno quadrato

Jesper set 3

Torre con tetto + parete da arrampicata + trave oscillante

Su ordinazione 



Lo scivolo è un optional

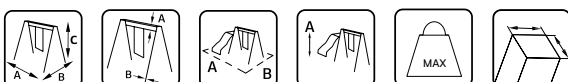

A: 361 cm
B: 304 cm
C: 314 cm
A: 90 x 90 mm
B: 70 x 70 mm
A: 761 cm
B: 704 cm
A: 120 cm
3-14 anni massimo 50 kg
Legno quadrato





ANCORAGGIO
Articolo nr. 100997



COLLARE ALTALENA
diametro 10 cm
Articolo nr. 101001



COLLARE ALTALENA
9 x 9 cm
Articolo nr. 108275



MORSETTO ALTALENA
Articolo nr. 108274

Scivoli per aree giochi

| ARTICOLO NUMERO | ALTEZZA PIATTAFORMA | COLORE SCIVOLO |
|-----------------|---------------------|----------------|
| 101005 | 150 ± 5 cm | Verde |
| 101006 | 150 ± 5 cm | Rosso |
| 101007 | 150 ± 5 cm | Blu |
| 101004 | 120 ± 5 cm | Rosso |
| 107382 | 120 ± 5 cm | Blu |

| | | |
|--------|------------|-------|
| 101005 | 150 ± 5 cm | Verde |
| 101006 | 150 ± 5 cm | Rosso |
| 101007 | 150 ± 5 cm | Blu |
| 101004 | 120 ± 5 cm | Rosso |
| 107382 | 120 ± 5 cm | Blu |



Accessori per parchi giochi



SEGGIOLINO LIBERO
Articolo nr. 101000



NEST SWING SWIBEE
Articoli nr. 100245, 100246



MONKEY SWING
Articolo nr. 107393



SCALETTA
Articolo nr. 107397



**TELO SOTTOFONDO
PER SABBIERA**
Articolo nr. 107502



PIETRE D'ARRAMPICATA
5 pezzi/pacco
Articolo nr. 107398



Maggiori
informazioni

23

MOBILI DA GIARDINO



Sanne 18

Articolo nr. 100821

Su ordinazione 



A: 180 cm
B: 74/37 cm
C: 75/42 cm

Ruby 18

Articolo nr. 103165

Su ordinazione 



A: 179 cm
B: 161 cm
C: 72 cm

Oscar

Articolo nr. 100762

Su ordinazione 



A: 231 cm
B: 231 cm
C: 73 cm

Leo

Articolo nr. 109524

Su ordinazione 



A: 198 cm
B: 200 cm
C: 242 cm

Sigrid

Articolo nr. 100753

Su ordinazione 



A: 193 cm
B: 161 cm
C: 198 cm

Ruby 24

Articolo nr. 100787

Su ordinazione 



A: 239 cm
B: 161 cm
C: 72 cm

Arthur

Articolo nr. 100797

Su ordinazione 



A: 274 cm
B: 274 cm
C: 73 cm

Aron

Articolo nr. 110316

Su ordinazione 



A: 99/37 cm
B: 99/37 cm
C: 107/74 cm

WPC



WPC - Wood Plastic Composite

COS'È

Il WPC è un materiale composito formato principalmente da:

- **Fibre di legno riciclato**
- **Polimeri plastici riciclati**
- **Additivi** che migliorano resistenza, stabilità, colore e protezione UV

Nasce tramite **estrusione a caldo**, che crea doghe e profili estremamente resistenti.

CARATTERISTICHE PRINCIPALI

- **Aspetto simile al legno**, ma più duraturo
- **Elevata resistenza** a: acqua, umidità, muffe, funghi, insetti, salsedine
- **Inattaccabile da tarli e parassiti**
- **Non si scheggia, non si deforma, non marcisce**
- **Superficie antiscivolo** e piacevole al tatto
- **Ottima resistenza ai raggi UV**
- **Bassa manutenzione** (non richiede oli o trattamenti)
- **Sostenibile**, grazie all'uso di materiali riciclati e alla riciclabilità del prodotto finito

Può essere lavorato come il legno.

PERCHÉ USARE IL PVC AL POSTO DI ALTRI POLIMERI

- **Dilatazione minima**
- **Resistente ad alte e basse temperature**
- **Ottimo isolante**
- **Ignifugo**
- **Meccanicamente molto robusto**

PERCHÉ SOLO IL 20% DI LEGNO

Mantenere una bassa percentuale di legno preserva:

- stabilità dimensionale
- resistenza nel tempo
- durabilità anche in condizioni severe



CARATTERISTICHE DEL WPVC ARTIGIANALE ITALIANO

- Prodotto interamente in Italia
- Filiera controllata e di lunga esperienza (35 anni)
- Profilo **espanso e alleggerito**, con peso simile al legno
- Facilmente lavorabile
- Incollabile, lavorabile, resistente, stabile



DOVE SI USA IL WPC

È ideale per applicazioni esterne grazie alla sua durabilità:

-  **Pavimentazioni (decking)**
-  **Arredo urbano e giardino**
-  **Rivestimenti**

PERCHÉ È ECOLOGICO

-  Realizzato con **100% materiali riciclati** (legno + plastica)
-  **Certificazione PSV**
-  **Completamente riciclabile a fine vita**



WPVC - WPC ARTIGIANALE A BASE PVC

Il WPVC è una variante particolare del WPC, composta generalmente da:

- **80% PVC**
- **20% farina di legno**

INSTALLAZIONE E MANUTENZIONE DEL WPC ESTERNO

Il **sistema di fissaggio a clip nascosto** è una caratteristica distintiva dei nostri pavimenti. Questo metodo non solo accelera l'installazione ma crea anche una superficie uniforme e sicura, senza viti visibili.

Per quanto riguarda la manutenzione, il **WPC esterno** si distingue per la sua praticità. A differenza del legno tradizionale, **non richiede manutenzione periodica**. La pulizia regolare con acqua e sapone neutro è sufficiente per mantenere l'aspetto originale del pavimento.

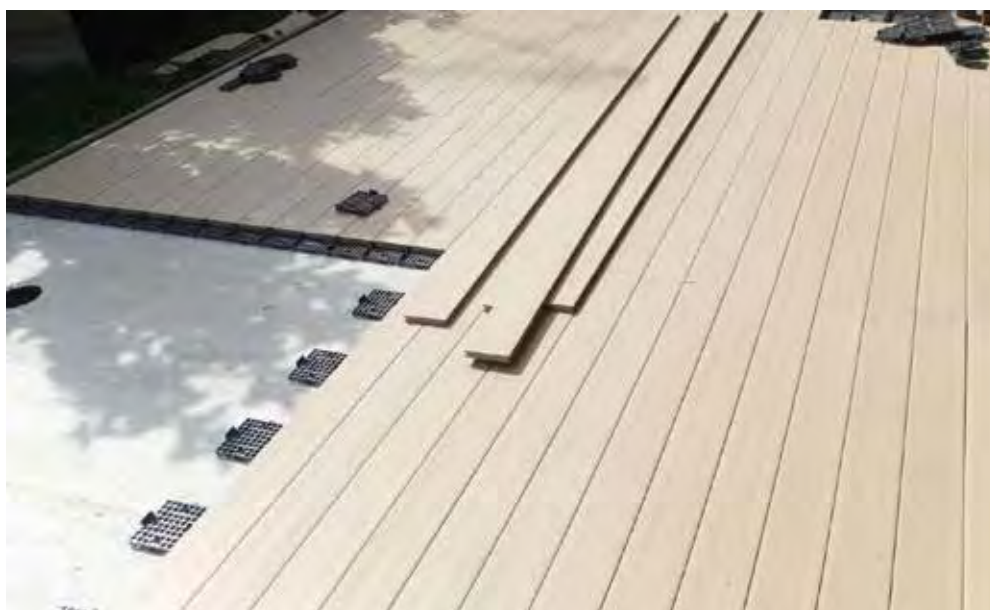

DIMENSIONI LISTONI DI CALPESTIO

Spessore
22 mm

Larghezza
13 cm

Lunghezza
300 cm

Note

Il pavimento viene fornito completo di clips in plastica spessore 18 mm (nr. 21 pz x mq)

| ARTICOLO NUMERO | DESCRIZIONE | MINIMO D'ORDINE |
|-----------------|--|-----------------|
| PF/G04 | Pavimentazione con superficie zigrinata color grigio chiaro | 10 mq |
| PF/G02 | Pavimentazione con superficie zigrinata color nocciola | 10 mq |
| PF/L01 | Pavimentazione con superficie venata effetto legno color marrone | 10 mq |

NB: Le clips devono essere fissate al massetto sottostante.

Picnic Sun

Articolo
PF/SUN

 **Materiale**
WPC

Su ordinazione 



DIMENSIONI

Spessore tavole
22 mm

Dimensione tavolo
180 x 80 cm

Dimensione panche
180 x 25 cm (seduta armata
spessore 45 mm)

Dimensioni totali
cm 180 x 160 x 75 h

SERVIZI

Scarico con sponda idraulica

 Disponibile

Dropshipping

 Disponibile, vedi condizioni a pag. 132

Panca Dori

Articolo
PF/DORI

 **Materiale**
WPC

Su ordinazione 



DIMENSIONI

Spessore tavole
45 mm

Dimensioni totali
180 x 80 cm

SERVIZI

Scarico con sponda idraulica

 Disponibile

Dropshipping

 Disponibile, vedi condizioni a pag. 132

Poltrona Kate

Articolo
PF/KATE

Su ordinazione 

 **Materiale**
WPC



DIMENSIONI

Spessore tavole
22 mm

Dimensioni totali
96 x 96 cm

SERVIZI

Scarico con sponda idraulica

 Disponibile

Dropshipping

 Disponibile, vedi condizioni a pag. 132

Cestino City

Articolo
PF/CITY

Su ordinazione 

 **Materiale**
WPC



DIMENSIONI

Spessore tavole
18 mm

Diametro cestino
30 cm

Altezza cestino
45 cm

Altezza totale
150 cm

CAPACITÀ

30 litri

SERVIZI

Scarico con sponda idraulica

 Disponibile

Dropshipping

 Disponibile, vedi condizioni a pag. 132

Dropshipping Condizioni di consegna al cliente finale

MODALITÀ OPERATIVE

Gli ordini devono essere inviati a ordini@losalegnami.com e devono contenere:

- Indirizzo completo del cliente finale (nome, cognome, via, CAP, località, provincia)
- Recapito telefonico (fisso e mobile)
- Eventuale richiesta di consegna con camion di piccole dimensioni
- Qualsiasi informazione utile per effettuare la consegna in modo corretto

Alla ricezione dell'ordine, **Losa Legnami Srl** invierà al Rivenditore la conferma d'ordine, che dovrà essere restituita **timbrata e firmata**.

La merce verrà spedita con **DDT Losa Legnami Srl intestato al Rivenditore** e destinato al cliente finale, senza alcuna indicazione di importi.

CONSEGNA DEI PRODOTTI

- La consegna avviene tramite corriere fino al **punto più vicino raggiungibile** dal mezzo (Isole minori escluse).
- Il servizio include **assicurazione e preavviso telefonico**.
- La consegna si intende al **piano strada**; non è previsto il trasporto ai piani.
- L'indirizzo del cliente finale deve essere **accessibile a camion di medie dimensioni**.
- La consegna con **mezzo piccolo** deve essere richiesta al momento dell'ordine ed è soggetta a verifica di compatibilità con la merce.
- Il trasporto **non comprende facchinaggio** né consegne in zone ZTL o centri storici. Questo servizio può essere fornito previa richiesta e preventivo.
- Alcuni articoli possono essere scaricati con **sponda idraulica**; per gli altri, in assenza di mezzi idonei, il cliente deve organizzare lo scarico manuale (3 - 4 persone) o richiedere il servizio di facchinaggio.
- Le consegne vengono effettuate dal lunedì al venerdì, **9:00 - 18:00**, previo appuntamento concordato dal vettore.
- In caso di mancata consegna, la merce sarà messa in **giacenza per 5 giorni** al costo di 80,00 €. Trascorso tale termine, la merce rientrerà ai magazzini Losa Legnami.

VERIFICA DELLA MERCE

All'arrivo della merce, il cliente finale deve:















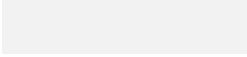

- controllare che il **numero dei colli** corrisponda al DDT;
- verificare che gli **imballi** siano integri e non danneggiati.

Qualsiasi anomalia deve essere immediatamente segnalata sul documento del corriere mediante "**Riserva di controllo**" scritta, specificando il motivo (es. "collo mancante", "imballo danneggiato").

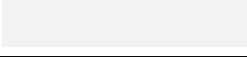







Verniciatura Colorazioni

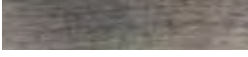

| ARTICOLO NUMERO | DESCRIZIONE | | COLORE PRINCIPALE / FINITURE | |
|-----------------|-------------------------------|-------------------|---|---|
| PNT7042A | Grigio chiaro + antracite | RAL7042 + RAL7016 |  |  |
| PNT7012A | Grigio scuro + antracite | RAL7012 + RAL7016 |  |  |
| PNT9016A | Bianco + antracite | RAL9016 + RAL7016 |  |  |
| PNT7042W | Grigio chiaro + bianco | RAL7042 + RAL9016 |  |  |
| PNT7012W | Grigio scuro + bianco | RAL7012 + RAL9016 |  |  |
| PNT9016W | Bianco + bianco | RAL9016 + RAL9016 |  |  |
| PNT7042H | Grigio chiaro + grigio chiaro | RAL7042 + RAL7042 |  |  |
| PNT7012G | Grigio scuro + grigio scuro | RAL7012 + RAL7012 |  |  |

Impregnazione Colorazioni

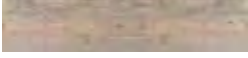

| ARTICOLO NUMERO | DESCRIZIONE | |
|-----------------|---|---|
| NO | Legno naturale, non trattato |  |
| BNDIP | Marrone a immersione |  |
| GYDIP | Grigio a immersione |  |
| WTDIP | Bianco chiaro a immersione |  |
| GYVPI | Grigio trattato a pressione in autoclave |  |
| BNVPI | Marrone trattato a pressione in autoclave |  |



Impregnazione ad immersione



Dettaglio del trattamento in autoclave

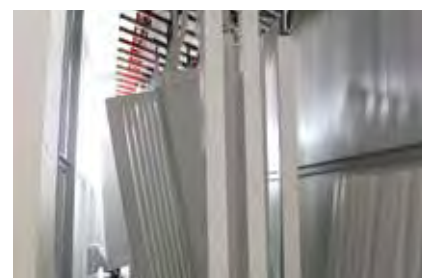

Prodotti verniciati in camera di essiccazione

Descrizione dei simboli

| | | | | |
|--|--|------|--|---|
| | | | | Spessore della parete / elemento / trave |
| | | | | Altezze (A: altezza della parete; B: altezza totale) |
| | | | | Perline sottotetto e pavimento |
| | | | | Vetro porta / finestra |
| | | EPDM | | Guaina, tegole canadesi o EPDM |
| | | | | Grondaie |
| | | | | Misure del prodotto assemblato |
| | | | | Diametro del dettaglio |
| | | | | Zona di sicurezza |
| | | | | Altezza della piattaforma scivolo |
| | | | | Limite di età / peso |
| | | | | Legno rotondo |
| | | | | Legno quadrato |
| | | | | Traversina mini |
| | | | | Legno lamellare incollato |
| | | | | Disponibile verniciato |
| | | | | Disponibile impregnato ad immersione |
| | | | | Articolo in pronta consegna |
| | | | | Articolo su ordinazione con tempi di consegna di 20 giorni lavorativi |



5 anni di garanzia
per le case in legno



2 anni di garanzia
per i giochi e le altalene



**Abbiamo sempre lo sguardo proiettato al futuro,
ed è proprio in quest'ottica che abbiamo deciso di certificare
la provenienza del legno che compone tutta la nostra gamma.
Ci impegnamo ogni giorno per darci e dare un futuro al nostro lavoro.**

esternidavivere.it



Losa Legnami S.r.l.

Via Strada Regia, 1/3

24030 Prezzate di Mapello (BG)

Tel. 035 908385 - Fax 035 4945073

info@losalegnami.com