

Shed-in-a-Box®

3,0 x 3,0 x 2,4 m

#70333EU

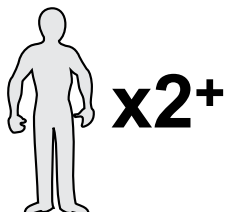
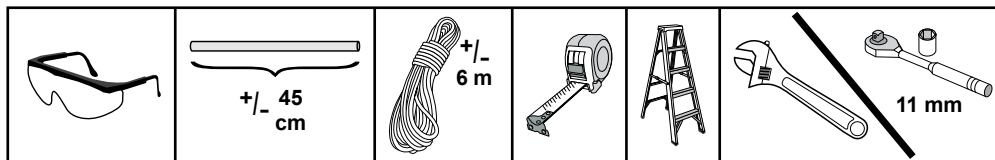

- = Helpful information
- = Nützliche Informationen
- = Information utile
- = Información útil
- = Informazioni utili
- = Nuttige informatie
- = Informação útil



ShelterLogic®

www.shelterlogic.eu

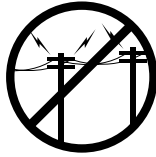
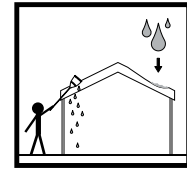
**GB****DE****FR****IMPORTANT:**

The shelter product was not tested for wind and snow loads. Please watch the weather forecasts to be able to properly protect or disassemble the shelter before problems appear. This shelter product is manufactured with quality materials. Please read and understand the installation detail, warnings and cautions prior to beginning installation and keep it for future reference.

WARNINGS:

1. Your shelter's cover can be quickly removed and stored prior to severe weather conditions. If strong winds or adverse weather is forecasted in your area, we recommend removal of cover.
2. DO NOT install near roof lines or other structures that could shed snow, ice or excessive run off onto your shelter. DO NOT hang objects from the roof or support cables.
3. **Danger: Keep away from electrical wires.** Check for overhead utility lines, tree branches or other structures. Check for underground pipes or wires before you dig.
4. Prior to installation, consult with all local municipal codes regarding installation of temporary shelters.
5. Risk of fire. DO NOT smoke or use open flame devices (including grills, fire pits, deep fryers, smokers or lanterns, etc.) in or around the shelter. DO NOT store flammable liquids (gasoline, kerosene, propane, etc.) in or around your shelter. Do not expose top or sides of the shelter to open fire or other flame source.
6. Please anchor this ShelterLogic® Corp. structure properly. See manual for more anchoring details. Proper anchoring, keeping cover tight and free of snow and debris is the responsibility of the consumer.
7. Use CAUTION when erecting the frame. Use safety goggles during installation. Secure and bolt together overhead poles during assembly. Be aware of pole ends.
8. Immediately remove any accumulated snow or ice from the roof structure with a broom, mop or other soft-sided instrument. Use extreme caution when removing snow from cover- always remove from outside the structure. DO NOT use hard-edged tools or instruments like rakes or shovels to remove snow. This could result in punctures to the cover.

PROPER ANCHORING AND INSTALLATION OF FRAME:

PROPER ANCHORING OF THE FRAME IS THE RESPONSIBILITY OF THE CONSUMER.

ShelterLogic® Corp. is not responsible for damage to the unit or the contents from acts of nature. Any shelter that is not anchored securely has the potential to fly away causing damage, and is not covered under the warranty. Periodically check the anchors to ensure stability of shelter. ShelterLogic® Corp. cannot be responsible for any shelter that blows away and cause personal injury or property damage. Adjustable cover slides up and down to fit height of wood stack. Neatly store your firewood outside your door. It is ready for use without the clutter.

CAUTION:

1. Choose the location of your shelter carefully. Please find a flat and even ground base.
2. Please check whether the ground base is suitable for your purpose.
3. Bungees are consumable parts. Used bungees must be replaced.
4. ShelterLogic® Corp. custom fabric should not come into contact with any objects with sharp edges.

BEFORE FIRST USAGE:

1. Please unpack the cartons and check against the packing list enclosed whether all parts have been delivered.
4. The screws joining the pipes with connectors must be tightened manually.

CARE AND CLEANING:

1. A tight cover ensures longer life and performance. Always maintain a tight cover. Loose fabric can accelerate deterioration of cover fabric. DO NOT use bleach or harsh abrasive products to clean the fabric cover. Cover is easily cleaned with mild soap and water.

WARRANTY, REPLACEMENT PARTS, QUESTIONS:

If you need have any problems, please contact your local dealer or contact us at: shelterlogic.eu

WICHTIG!

Diese Zelthalle wurde nicht auf Wind- und Schneelast geprüft. Bitte verfolgen Sie den Wetterbericht, um die Halle bei Gefahr ggf. abzubauen oder zu sichern. Die Zelthalle wird aus Qualitätsmaterialien hergestellt. Lesen Sie die Aufbauanleitung, die Warnhinweise und die Gefahrenhinweise vor dem Aufbauen durch und bewahren Sie die Anleitung für den späteren Gebrauch auf.

WARNUNGEN:

1. Bei drohendem Unwetter lässt sich die Plane schnell abnehmen und verstauen. Wir empfehlen, die Plane abzunehmen, wenn in Ihrer Region Sturm- oder Schlechtwetterwarnungen ausgegeben werden.
2. Bauen Sie die Zelthalle NICHT in der Nähe von Dachüberständen oder anderen Strukturen auf, von denen Schnee, Eis oder starke Regengüsse auf die Halle niedergehen könnten. Hängen Sie KEINE Gegenstände an das Dach oder an die Tragkonstruktion.
3. **Gefahr: Halten Sie Abstand zu elektrischen Kabeln.** Achten Sie auf Versorgungsleitungen, Äste oder andere Strukturen. Achten Sie auf im Boden verlegte Rohre oder Kabel, bevor Sie graben.
4. Informieren Sie sich vor dem Aufbauen über die geltenden kommunalen Vorschriften zum temporären Aufbau von Zelthallen.
5. Brandgefahr. Rauchen Sie NICHT in oder in Nähe der Zelthalle und verwenden Sie keine Geräte mit offener Flamme (wie beispielsweise Grills, Feuerstellen, Fritteusen, Räucheröfen oder Laternen usw.). Lagern Sie KEINE brennbaren Flüssigkeiten (wie beispielsweise Benzin, Kerosin, Propan usw.) in oder in Nähe der Zelthalle. Richten Sie kein offenes Feuer oder eine sonstige Flammenquelle gegen das Dach oder die Seiten der Zelthalle.
6. Verankern Sie die ShelterLogic® Corp.-Zelthalle vorschriftsmäßig. Nähere Informationen hierzu finden Sie in der Anleitung. Der Kunde ist dafür verantwortlich, das Produkt einwandfrei zu verankern, die Plane zu straffen und frei von Schnee und Ablagerungen zu halten.
7. Seien Sie beim Aufbau des Gestänges VORSICHTIG. Tragen Sie beim Aufbauen eine Schutzbrille. Befestigen Sie beim Aufbauen die Pfetten und verschrauben Sie diese miteinander. Achten Sie auf die Gestängeenden.
8. Entfernen Sie auf dem Dach befindlichen Schnee unverzüglich mit einem Besen, Mopp oder einem anderen Gerät, das eine weiche Seite hat. Gehen Sie sehr vorsichtig vor, wenn Sie Schnee von der Plane entfernen. Entfernen Sie den Schnee immer von außen. Verwenden Sie KEINE scharf- oder hartkantigen Werkzeuge oder Geräte, wie beispielsweise Harken, Rechen oder Schaufeln, um Schnee zu entfernen. Dies könnte die Plane beschädigen.

VORSCHRIFTMÄSSIGES VERANKERN UND AUFBAUEN DES GESTÄNGES:

DER KUNDE IST DAFÜR VERANTWORTLICH, DAS GESTÄNGE VORSCHRIFTMÄSSIG ZU VERANKERN.

ShelterLogic® Corp. haftet nicht für Schäden an dem Produkt oder dessen Inhalt, die auf Naturereignisse oder höhere Gewalt zurückzuführen sind. Eine nicht vorschriftsmäßig verankerte Zelthalle kann vom Wind erfasst werden und Schäden verursachen, die nicht unter die Gewährleistung fallen. Prüfen Sie die Verankerung regelmäßig, um die Stabilität der Zelthalle sicherzustellen. ShelterLogic® Corp. haftet nicht für Zelthallen, die vom Wind erfasst werden und dadurch Personen- oder Sachschäden verursachen. Die Plane lässt sich in der Höhe auf den Holzstapel einstellen. Das Brennholz findet vor dem Haus einen geeigneten Platz. So liegt es griffbereit, ohne Schmutz zu machen.

ACHTUNG:

1. Wählen Sie den Aufstellort für die Zelthalle sorgfältig aus. Der Untergrund sollte eben und flach sein.
2. Prüfen Sie, ob der Boden für den vorgesehenen Zweck geeignet ist.
3. Gummis sind Verschleißteile. Gebrauchte Gummis sind zu ersetzen.
4. Das ShelterLogic® Corp.-Gewebe darf nicht mit scharfkantigen Gegenständen in Berührung kommen.

VOR DEM ERSTEN GEBRAUCH:

1. Packen Sie die Kartons aus und kontrollieren Sie anhand der Packliste, ob alle Teile vorhanden sind.
4. Die Schrauben zur Verbindung der Rohre mit den Verbindungselementen werden von Hand angezogen.

PFLEGE UND REINIGUNG:

1. Gute Spannung trägt zur Funktion und Lebensdauer der Plane bei. Halten Sie die Plane daher stets gut gespannt. Das Gewebe der Plane altert ohne Spannung schneller. Verwenden Sie zur Reinigung der Plane keine Bleichmittel oder abrasiven Produkte. Säubern Sie die Plane mit milder Seifenlauge und Wasser.

GEWÄHRLEISTUNG, ERSATZTEILE, FRAGEN:

Bei Fragen oder Problemen wenden Sie sich bitte an Ihren Fachhändler oder direkt an uns unter: shelterlogic.eu

IMPORTANT :

L'abri n'a pas été testé pour résister au vent et aux charges de neige. Veuillez surveiller les prévisions météo afin de protéger correctement ou de démonter l'abri avant l'apparition de complications. Cet abri est fabriqué avec des matériaux de qualité. Veuillez lire attentivement les consignes d'installation, avertissements et mises en garde avant de commencer l'installation et conservez-les pour une consultation ultérieure.

AVERTISSEMENTS :

1. La toile de votre abri se démonte rapidement afin d'être rangée avant des intempéries. En cas de prévision de fortes rafales de vent ou d'intempéries dans votre région, nous recommandons de démonter la toile.
2. NE PAS installer près de toits ou d'autres structures pouvant entraîner un écoulement d'eau excessif ou la chute de neige ou de glace sur votre abri. NE PAS suspendre d'objets au toit ou aux câbles de support.
3. **Danger : restez à l'écart des lignes électriques.** Vérifiez qu'il n'y ait pas de lignes aériennes, de branches d'arbres ou d'autres structures à proximité de l'abri. Vérifiez qu'il n'y ait pas de conduites enterrées ou de câbles avant de creuser.
4. Avant l'installation, consultez tous les règlements de votre municipalité concernant l'installation d'abris temporaires.
5. Risque d'incendie. NE PAS fumer ou utiliser d'équipements à flamme nue (grills, feux de camp, friteuses, fumeurs ou lanternes, etc.) dans l'abri ou à proximité. NE PAS stocker de liquides inflammables (gasoil, kérosène, propane, etc.) dans l'abri ou à proximité. Ne pas exposer le haut ou les côtés de l'abri au feu ou à d'autres sources de flammes.
6. Veuillez ancrer cette structure ShelterLogic® Corp. de manière sécurisée. Consultez le manuel pour de plus amples détails concernant l'ancrage L'utilisateur est responsable de l'ancrage correct, du maintien de la tension de la toile et de l'absence de neige et de débris sur l'abri.
7. Procédez avec PRUDENCE lors du montage du cadre. Utilisez des lunettes de sécurité lors de l'installation. Sécurisez et vissez les mâts supérieurs durant l'assemblage. Faites attention aux extrémités des mâts.
8. Retirez immédiatement toute accumulation de neige ou de glace de la structure du toit avec un balai, une serpillière ou tout autre instrument à bords souples. Procédez avec une extrême prudence lorsque vous retirez la neige du toit ; passez toujours par l'extérieur de la structure. NE PAS utiliser des outils ou des instruments à bords durs comme des râtaux ou des pelles pour enlever la neige. Cela pourrait trouser la toile.

ANCRAGE ET INSTALLATION CORRECTS DU CADRE:

L'UTILISATEUR EST RESPONSABLE DE L'ANCRAGE CORRECT DU CADRE.

ShelterLogic® Corp. n'est pas responsable des dommages du produit ou de son contenu en cas d'événement naturel. Tout abri qui n'est pas correctement ancré risque de s'envoler et de causer des dommages ; cela n'est aucunement couvert par la garantie. Contrôlez régulièrement les ancrages pour assurer la stabilité de l'abri. ShelterLogic® Corp. ne saurait être tenu responsable d'un abri qui s'envolerait et qui causerait des dégâts matériels voire des blessures physiques. La couverture ajustable monte et descend en fonction de la hauteur du tas de bois. Rangez proprement le bois de chauffage à l'extérieur. Il est prêt à l'utilisation et bien rangé.

ATTENTION :

1. Choisissez attentivement l'emplacement de votre abri. Veuillez opter pour une surface de base plane et régulière.
2. Veuillez contrôler si la surface de base convient à l'utilisation visée.
3. Les tendeurs sont des produits soumis à l'usure. Les tendeurs usés doivent être remplacés.
4. La toile ShelterLogic® Corp. ne doit pas entrer en contact avec des objets coupants.

AVANT LA PREMIERE UTILISATION:

1. Veuillez débarrasser les cartons et contrôler que toutes les pièces sont présentes, conformément à la liste.
4. Les vis qui raccordent les tubes avec des connecteurs doivent être serrées manuellement.

ENTRETIEN ET NETTOYAGE :

1. Une toile tendue assure une durée de vie plus longue et de meilleures performances. Tendez toujours la toile. Une toile détendue peut se détériorer plus rapidement. NE PAS utiliser d'eau de Javel ou de produits abrasifs pour nettoyer la toile. La toile se nettoie facilement avec un savon doux et de l'eau.

GARANTIE, PIÈCES DE RECHANGE, QUESTIONS :

En cas de problème, veuillez contacter votre revendeur local ou contactez-nous sur : shelterlogic.eu

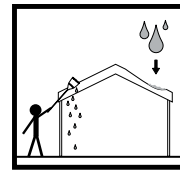
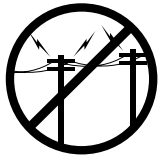

SP

IMPORTANTE:

La cubierta no fue sometida a pruebas en lo concerniente al viento y las cargas de nieve. Por favor, revise el pronóstico del tiempo a fin de que cuente con criterios para proteger correctamente el refugio o desmontarlo antes de que surjan problemas. Esta cubierta ha sido manufacturada con materiales de calidad. Por favor, lea y comprenda las indicaciones de instalación, advertencias y precauciones antes de iniciar el montaje y conserve las instrucciones para futuras consultas.

ADVERTENCIAS:

1. La cubierta de su refugio se puede desmontar y almacenar rápidamente antes de que aparezcan condiciones ambientales severas. Si, en su zona, se han pronosticado fuertes vientos o condiciones meteorológicas adversas, recomendamos que desmonte la cubierta.
2. NO realice la instalación cerca de bordes de tejados o de otras estructuras desde las que, sobre su refugio, se pueda desprender nieve, hielo o una caída excesiva de agua. NO suspenda objetos del techo ni de las estructuras de soporte.
3. **Peligro: Instale la cubierta en un lugar alejado de los cables de electricidad.** Tenga cuidado con las líneas aéreas de la red, las ramas de los árboles u otras estructuras. Antes de empezar a cavar, compruebe la ausencia de tuberías o cables en el suelo.
4. Antes de la instalación, consulte todas las normativas locales de su comunidad relacionadas con el montaje de refugios temporales.
5. Peligro de incendio. NO fume ni use dispositivos que produzcan una flama abierta (inclusive parrillas, fogatas, freidoras, hornos para ahumar, faroles, etc.) dentro o alrededor del refugio. NO almacene líquidos inflamables (gasolina, queroseno, propano, etc.) dentro o alrededor de su refugio. No exponga al fuego ni a cualquier otra fuente de llamas la parte superior ni las laterales del refugio.
6. Por favor, fije correctamente la estructura de este refugio de ShelterLogic® Corp. Consulte el manual para conocer mayores detalles acerca de la instalación. La fijación correcta, el tensado permanente de la cubierta y el hecho de mantenerla libre de nieve y desechos constituye responsabilidad del usuario.
7. Tenga PRECAUCIÓN al levantar el marco. Use gafas de protección durante la instalación. Asegure y atornille las barras superiores durante el montaje. Tenga cuidado con los extremos de las barras.
8. Retire de inmediato la nieve o el hielo que se haya acumulado sobre el techo de la estructura empleando una escobilla, una fregona o cualquier otro instrumento de bordes suaves. Tenga un cuidado extremo cuando retire la nieve de la cubierta y hágalo siempre desde el exterior de la estructura. NO use una herramienta que tenga bordes duros para retirar la nieve, como es el caso de los rastrillos o palas. Esto podría perforar la cubierta.

FIJACIÓN E INSTALACIÓN CORRECTA DEL MARCO: LA FIJACIÓN CORRECTA DEL MARCO ES RESPONSABILIDAD DEL USUARIO.

ShelterLogic® Corp. no es responsable de daños sufridos por el producto o por lo que albergue si esto se deriva de la acción de la naturaleza. Todo refugio que no se haya fijado seguramente puede, potencialmente, ser elevado por el viento y causar daños, hecho que no cubre la garantía. Controle periódicamente las fijaciones para asegurar la estabilidad del refugio. No se puede responsabilizar a ShelterLogic® Corp. por ningún refugio que, llevado por el viento, haya causado heridas a personas o daños a la propiedad. La cubierta ajustable se desliza hacia arriba y hacia abajo para fijar la altura de la pila de madera. Almacene cuidadosamente la madera de su chimenea en el exterior. Así la tendrá siempre a disposición sin desorden.

CUIDADO:

1. Seleccione cuidadosamente la ubicación de su refugio. Por favor, elija una superficie plana y pareja.
 2. Por favor, compruebe si la superficie es apta para sus propósitos.
 3. Componentes elásticos y piezas de desgaste. Es necesario reemplazar los componentes elásticos desgastados por el uso.
 4. Los tejidos de ShelterLogic® Corp. no deben entrar en contacto con ningún objeto que tenga filos cortantes.
- Antes del primer uso:
1. Por favor, desempaque los cartones y, en función de la lista incluida, revise si el suministro incluye todos los componentes.
 4. Los tornillos que unen las tuberías con sus conexiones tienen que apretarse manualmente.

CUIDADO Y LIMPIEZA:

1. Una cubierta tensada asegura su larga vida útil y sus prestaciones. Mantenga la cubierta siempre tensada. El tejido suelto puede acelerar el deterioro de la cubierta. NO use lejía ni productos abrasivos para limpiar el tejido de la cubierta. Esto se puede llevar a cabo sencillamente con agua y un jabón suave.

GARANTÍA, PIEZAS DE RECAMBIO, PREGUNTAS:

Si se le presenta algún problema, por favor, póngase en contacto con su distribuidor local o con nosotros, en la dirección: shelterlogic.eu

IT

IMPORTANTE:

La struttura non è stata testata per carichi di neve e vento. Verificare le previsioni meteo al fine di proteggere adeguatamente la struttura o smontarla prima che si verifichi un problema. La struttura è prodotta con materiali di qualità. Prima di procedere all'installazione, leggere attentamente i dati relativi al montaggio, le avvertenze e le precauzioni e conservarli a scopo di riferimento futuro.

AVVERTENZE:

1. La copertura della struttura si può rimuovere rapidamente ed essere riposta prima che si verifichino condizioni meteo avverse. Si raccomanda la rimozione della copertura in caso di venti forti o maltempo previsti nell'area.
2. NON posizionare in prossimità di sagome dei tetti o altri elementi da cui potrebbero cadere neve, ghiaccio o deflusso eccessivo sulla struttura stessa. NON appendere oggetti al tetto o ai cavi di sostegno.
3. **Peligro: allontanarsi da fili elettrici.** Controllare le linee di servizio sopraelevate, i rami degli alberi o altri elementi. Prima di procedere allo scavo, controllare cavi o tubature sotterranee.
4. Prima del montaggio, consultare le disposizioni municipali locali relative all'installazione di strutture temporanee.
5. Rischio di incendio. NON fumare né utilizzare fiamme libere (comprese griglie, focolari, friggitorici, barbecue o lanterne, ecc.) all'interno o in prossimità della struttura. NON conservare liquidi infiammabili (benzina, cherosene, propano, ecc.) all'interno o in prossimità della struttura. Non esporre la parte superiore o laterale della struttura a fiamme libere o altre fonti di incendio.
6. Fissare adeguatamente la struttura ShelterLogic® Corp. Per ulteriori dettagli sul fissaggio, consultare il manuale. L'utente è responsabile di fissaggio corretto, mantenimento della copertura in tensione e rimozione di neve e sporizia.
7. Usare CAUTELA nell'erigere il telaio. Indossare occhiali protettivi durante l'installazione. Durante il montaggio, fissare e imbullonare i pali sopraelevati. Prestare attenzione alle estremità dei pali.
8. Rimuovere immediatamente eventuali accumuli di neve o ghiaccio dalla struttura del tetto con una scopa, uno spazzolone o un altro attrezzo morbido. Prestare estrema cautela nel rimuovere la neve dalla copertura; agire sempre dall'esterno della struttura. NON rimuovere la neve con strumenti o attrezzi con bordi rigidi come rastrelli o pale in quanto potrebbero perforare la copertura.

INSTALLAZIONE E FISSAGGIO CORRETTO DEL TELAIO: L'UTENTE È RESPONSABILE DEL FISSAGGIO CORRETTO DEL TELAIO.

ShelterLogic® Corp. non è responsabile dei danni all'unità o a quanto in essa contenuto a seguito di eventi naturali. Le strutture non adeguatamente fissate possono volare via provocando danni e non sono coperte dalla presente garanzia. Controllare periodicamente i fissaggi per accertare la stabilità della struttura. ShelterLogic® Corp. non è responsabile delle strutture spazzate via che provocano lesioni personali o danni a beni. La copertura regolabile è scorrevole in alto e in basso per adattarsi all'altezza delle pile di legna. Tenere ben pulita la legna da ardere posta all'esterno, in modo che risulti ordinata e pronta all'uso.

PRECAUZIONE:

1. Scegliere attentamente l'ubicazione della struttura, individuando un terreno piano e uniforme.
2. Controllare che il terreno sia adatto allo scopo.
3. I cavi elastici sono soggetti a usura e quelli usati devono essere sostituiti.
4. Il tessuto personalizzato di ShelterLogic® Corp. non dovrà essere posto a contatto con oggetti dai bordi affilati.

PRIMA DEL PRIMO UTILIZZO:

1. Rimuovere l'imballaggio di cartone e controllare con la distinta del contenuto allegata che tutti i componenti siano stati consegnati.
4. Serrare manualmente le viti che uniscono i tubi ai raccordi.

MANUTENZIONE E PULIZIA:

1. Una copertura tesa garantisce prestazioni e durata superiore. Mantenere la copertura costantemente tesa. Il tessuto allentato può accelerare il deterioramento della copertura. NON utilizzare candeggina o prodotti abrasivi aggressivi per pulire la copertura in tessuto. Utilizzare semplicemente sapone neutro e acqua.

GARANZIA, RICAMBI, DOMANDE:

Per eventuali problemi, contattare il rivenditore locale o noi su shelterlogic.eu

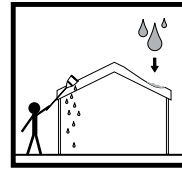
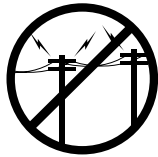
**DT****PT****BELANGRIJK!**

De tent is niet getest op wind- en sneeuwbelasting. Raadpleeg de weersvoorspellingen, zodat de tent adequaat kan worden beveiligd of gedemonteerd, voordat zich problemen voordoen. Deze tent is gemaakt van hoogwaardige materialen. De handleiding inclusief instructies en waarschuwingen dient vóór de montage te worden gelezen en begrepen. Bewaar deze zorgvuldig voor latere raadpleging.

WAARSCHUWINGEN:

1. Wanneer slecht weer in aantocht is, kan het tentzeil snel worden verwijderd en opgeborgen. Indien krachtige wind of ongunstig weer voor uw streek wordt voorspeld, adviseren wij het zeil te verwijderen.
2. Installeer de tent NIET dicht bij een dak of andere constructie waarvan sneeuw, ijs of grote hoeveelheden water op uw tent kunnen terechtkomen. Hang GEEN voorwerpen aan het dak of steunkabels.
3. **Gevaar! Verwijderd houden van stroomkabels.** Controleer de opstellingsplaats op overhangende kabels, takken en dergelijke. Controleer op ondergrondse leidingen, voordat u begint te graven.
4. Voordat u de tent opstelt, dient u de lokale overheidsvoorschriften met betrekking tot het opstellen van tijdelijke tenten te controleren.
5. Brandgevaar! Rook NIET en gebruik GEEN open vuur (inclusief barbecues, vuurmanden, frituurpannen, rookovens of lantaarns enz.) in of dicht bij de tent. Bewaar GEEN brandbare vloeistoffen (benzine, petroleum, propaan enz.) in of dicht bij de tent. Stel het dak of de zijwanden van de tent niet bloot aan open vuur of andere hittebronnen.
6. Zorg ervoor dat deze ShelterLogic® Corp. -constructie goed wordt verankerd. Raadpleeg de handleiding voor meer instructies met betrekking tot de verankering. Een goede verankering, het zeil strak gespannen en vrij van sneeuw en puin houden, behoort tot de verantwoordelijkheid van de klant.
7. Wees VOORZICHTIG bij het opstellen van het frame. Draag een veiligheidsbril tijdens de montage. Bevestig en schroef de stangen boven het hoofd tijdens de montage vast. Let op met de uiteinden van de stangen.
8. Sneeuw of ijs op het dak moet onmiddellijk worden verwijderd met een borstel, zwabber of ander geschikt, zacht gereedschap. Wees voorzichtig bij het verwijderen van sneeuw van het dak – verwijder altijd eerst de sneeuw aan de rand van de constructie. Gebruik GEEN harde voorwerpen of gereedschappen zoals harken of schoppen, om sneeuw te verwijderen. Deze kunnen gaten in het zeil maken.

GOED VERANKEREN EN INSTALLEREN VAN HET FRAME: DE GOEDE VERANKERING VAN HET FRAME IS DE VERANTWOORDELIJKHEID VAN DE KLANT.

ShelterLogic® Corp. stelt zich niet aansprakelijk voor schade aan de tent of inhoud die werd veroorzaakt door natuurgeweld. Bij een tent die niet veilig verankerd is, bestaat altijd het risico dat deze wegvliegt en schade veroorzaakt. Deze schade valt niet onder de garantie. Controleer daarom regelmatig de verankering, om de stabiliteit van de tent te verzekeren. ShelterLogic® Corp. kan niet aansprakelijk worden gesteld voor een wegvliegende tent die persoonlijk letsel of materiële schade veroorzaakt.

Het verstelbare zeil kan op en neer schuiven, om aan de hoogte van de houtstapel te worden aangepast. Stapel uw voorraad brandhout netjes buiten op. Zo ligt het altijd gebruiksklaar binnen handbereik.

LET OP!

1. Kies zorgvuldig de plaats voor uw tent. Zoek een vlakke en effen ondergrond.
2. Controleer of de ondergrond geschikt is voor uw doeleinden.
3. Elastieken zijn verbruiksgoederen. Gebruikte elastieken moeten worden vervangen.
4. De ShelterLogic® Corp. -zeilen mogen niet in aanraking komen met voorwerpen met scherpe randen.

VOOR HET EERSTE GEBRUIK:

1. Haal de inhoud uit de dozen en controleer deze aan de hand van de bijgevoegde paklijst op volledigheid.
4. De schroeven in de verbindingstukken tussen de stangen moeten met de hand worden aangedraaid.

ONDERHOUD EN REINIGING:

1. Een strak zeil verzekert een betere functie en langere levensduur. Zorg ervoor dat het zeil altijd strak gespannen is. Losse zeilen verslijten sneller. Gebruik GEEN bleekmiddelen of schurende producten om het zeil te reinigen. Het zeil kan eenvoudig worden gereinigd met water en een milde zeep.

GARANTIE, RESERVEONDERDELEN, VRAGEN:

Bij eventuele problemen kunt u terecht bij uw plaatselijke dealer of bij ons op: shelterlogic.eu

IMPORTANTE:

A tenda não foi testada sob cargas de vento e neve. Veja a previsão meteorológica para tomar providências adequadas para proteger a tenda ou desmontá-la em caso de surgirem problemas. Esta tenda foi fabricada com materiais de qualidade. Leia e compreenda as instruções de instalação, os avisos e as precauções antes de começar com a instalação e guarde-os para uma futura referência.

AVISOS:

1. A lona da sua tenda pode ser removida e guardada rapidamente em situações meteorológicas graves. Se a previsão do tempo indicar vento forte ou condições meteorológicas adversas para a sua região, recomendamos retirar a lona.
2. NÃO instale a tenda perto de telhados ou outras estruturas das quais possa cair neve, gelo ou precipitação excessiva para dentro da sua tenda. NÃO pendure objetos no teto ou nos cabos de suporte.
3. **Perigo: Manter afastado de cabos elétricos.** Preste atenção a linhas de eletricidade, ramos de árvores e outras estruturas. Verifique se existem tubos ou cabos no solo antes de inserir as estacas.
4. Antes da instalação, assegure-se de que cumpre as normas municipais relativamente à instalação temporária de tendas.
5. Risco de incêndio. NÃO fume nem utilize dispositivos de chamas abertas (incluindo grelhadores, braçadeiras, fritadeiras, radiadores ou lanternas, etc.) dentro ou nos arredores da tenda. NÃO guarde líquidos inflamáveis (gasolina, querosene, propano, etc.) dentro ou nos arredores da tenda. Não exponha o topo ou os lados da tenda ao fogo aberto ou a outra fonte de chamas.
6. Ancore corretamente esta estrutura ShelterLogic® Corp. Consulte o manual para mais informações sobre a ancoragem. O cliente é responsável por uma ancoragem correta, bem como por manter a lona bem fixa e livre de neve e destroços.
7. Proceda com CUIDADO na montagem da armação. Utilize óculos de proteção durante a instalação. Fixe com parafusos os tubos do teto durante a montagem. Preste atenção às extremidades dos tubos.
8. Remova imediatamente qualquer neve ou gelo acumulado na estrutura do teto com uma vassoura, esfregona ou outro instrumento macio. Tenha extremo cuidado quando remove a neve da lona – faça-o sempre fora da estrutura. NÃO utilize ferramentas ou instrumentos pontiagudos tais como ancinhos ou pás. Isto pode danificar a lona.

ANCORAGEM E INSTALAÇÃO CORRETAS DA ARMAÇÃO: O CLIENTE É RESPONSÁVEL POR UMA ANCORAGEM CORRETA DA ARMAÇÃO.

A ShelterLogic® Corp. não assume responsabilidade alguma por danos na unidade ou danos por força maior. Qualquer tenda que não seja corretamente ancorada pode ser levada pelo vento e causar danos. Estes danos não estão cobertos pela garantia. Verifique periodicamente a ancoragem para assegurar a estabilidade da tenda. A ShelterLogic® Corp. não assume responsabilidade por tendas que sejam levadas pelo vento e causem ferimentos em pessoas ou danos materiais.

A lona ajustável pode ser deslizada para cima e baixo para uma adaptação à altura do mastro de madeira.

Guarde a lenha arrumada fora da porta.

Esta tem de estar pronta para utilizar e não deve ter qualquer lixo.

CUIDADO:

1. Escolha com cuidado o local para a instalação da tenda. O solo deve ser plano e regular.
2. Verifique se o solo é adequado para os fins previstos.
3. Os esticadores são peças consumíveis. Os esticadores usados têm de ser substituídos.
4. O material têxtil ShelterLogic® Corp. não deve entrar em contacto com objetos de arestas vivas.

ANTES DA PRIMEIRA UTILIZAÇÃO:

1. Desembale as caixas e, com base na lista de embalagem incluída, verifique se todas as peças foram fornecidas.
4. Os parafusos para ligação dos tubos aos conectores têm de ser apertados manualmente.

CUIDADOS E LIMPEZA:

1. Uma lona bem fixa garante uma longa vida útil e um bom desempenho. Mantenha sempre a lona bem fixa. Uma lona solta pode acelerar o desgaste do material têxtil. NÃO utilize lixívia nem produtos abrasivos para a limpeza da lona. A lona pode ser limpa facilmente com um sabão suave e água.

GARANTIA, SUBSTITUIÇÃO DE PEÇAS, QUESTÕES:

Em caso de problemas, contacte o seu revendedor local ou a nossa sede através de: shelterlogic.eu

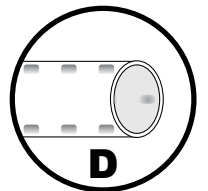
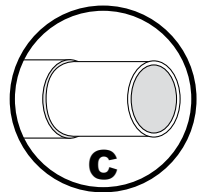
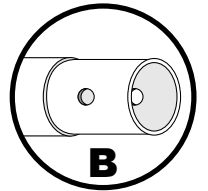
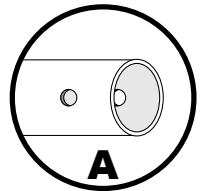
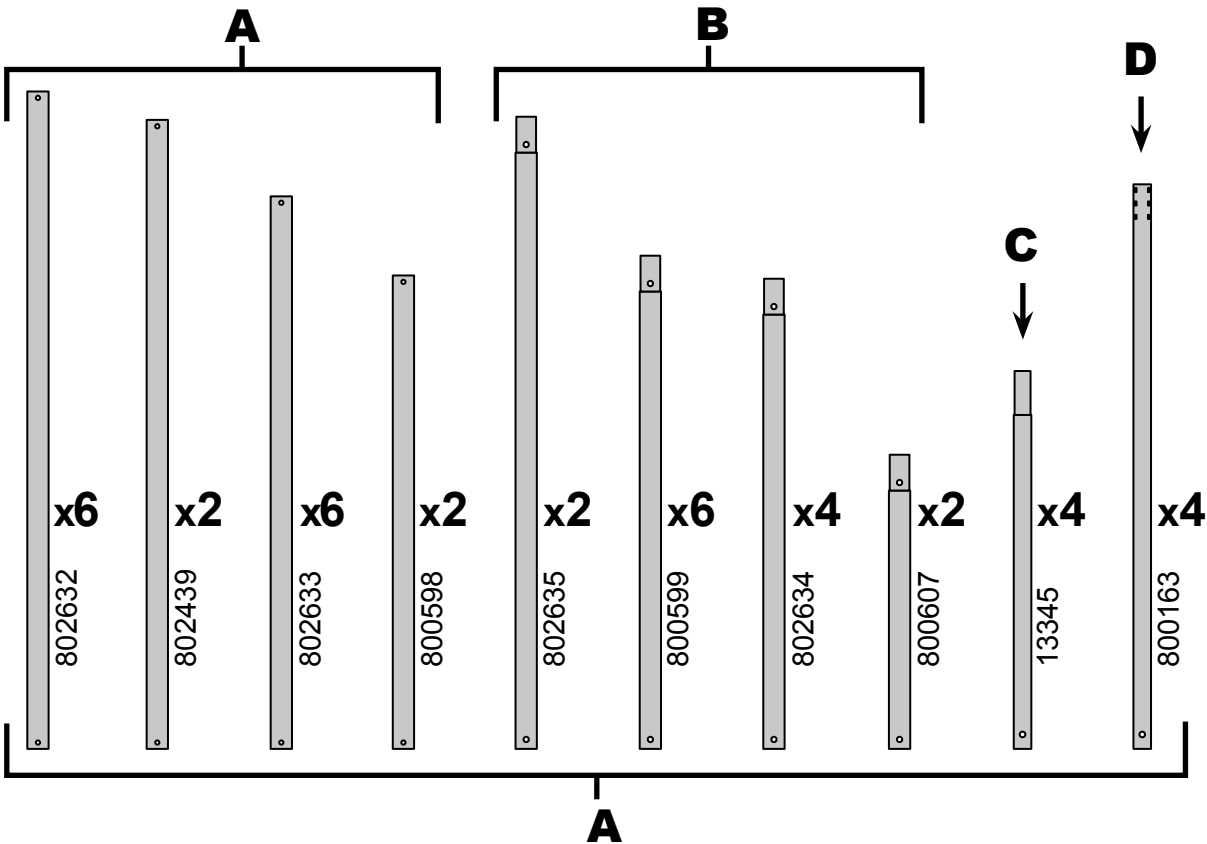
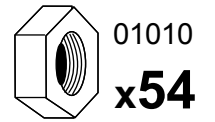
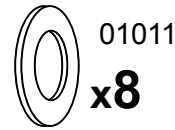
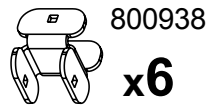
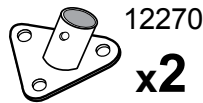
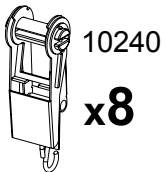
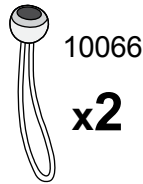
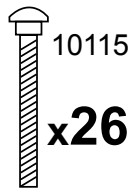
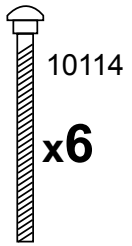
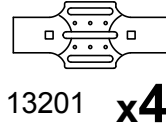
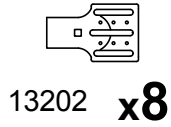
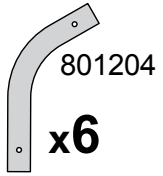
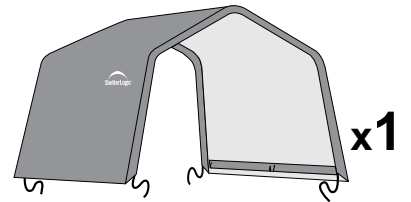
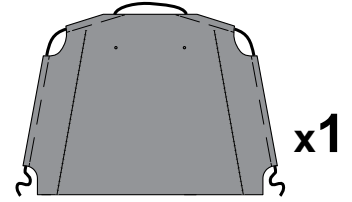
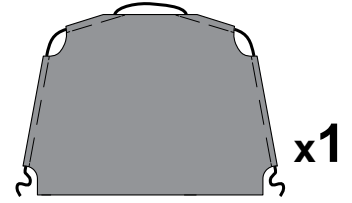
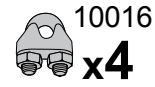
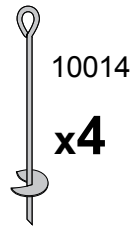
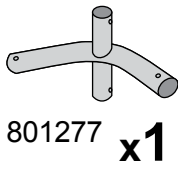
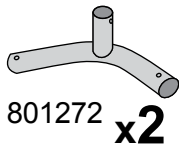
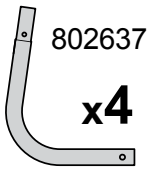

1.

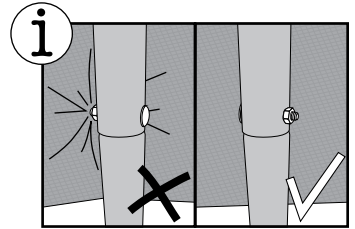
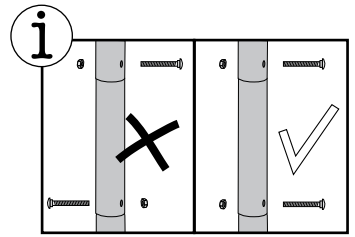
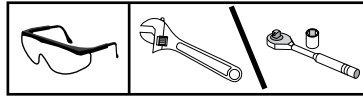

x2

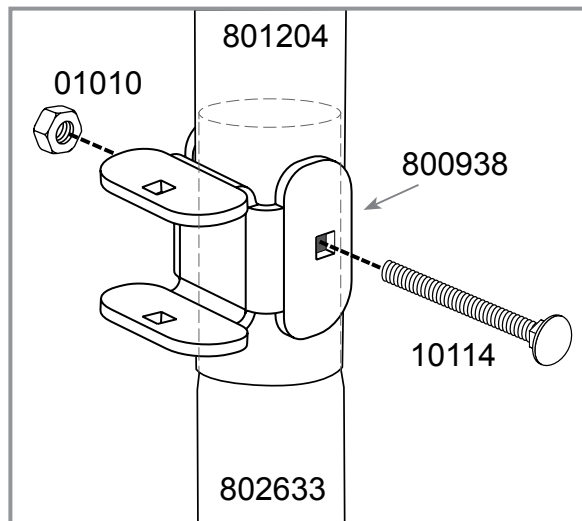
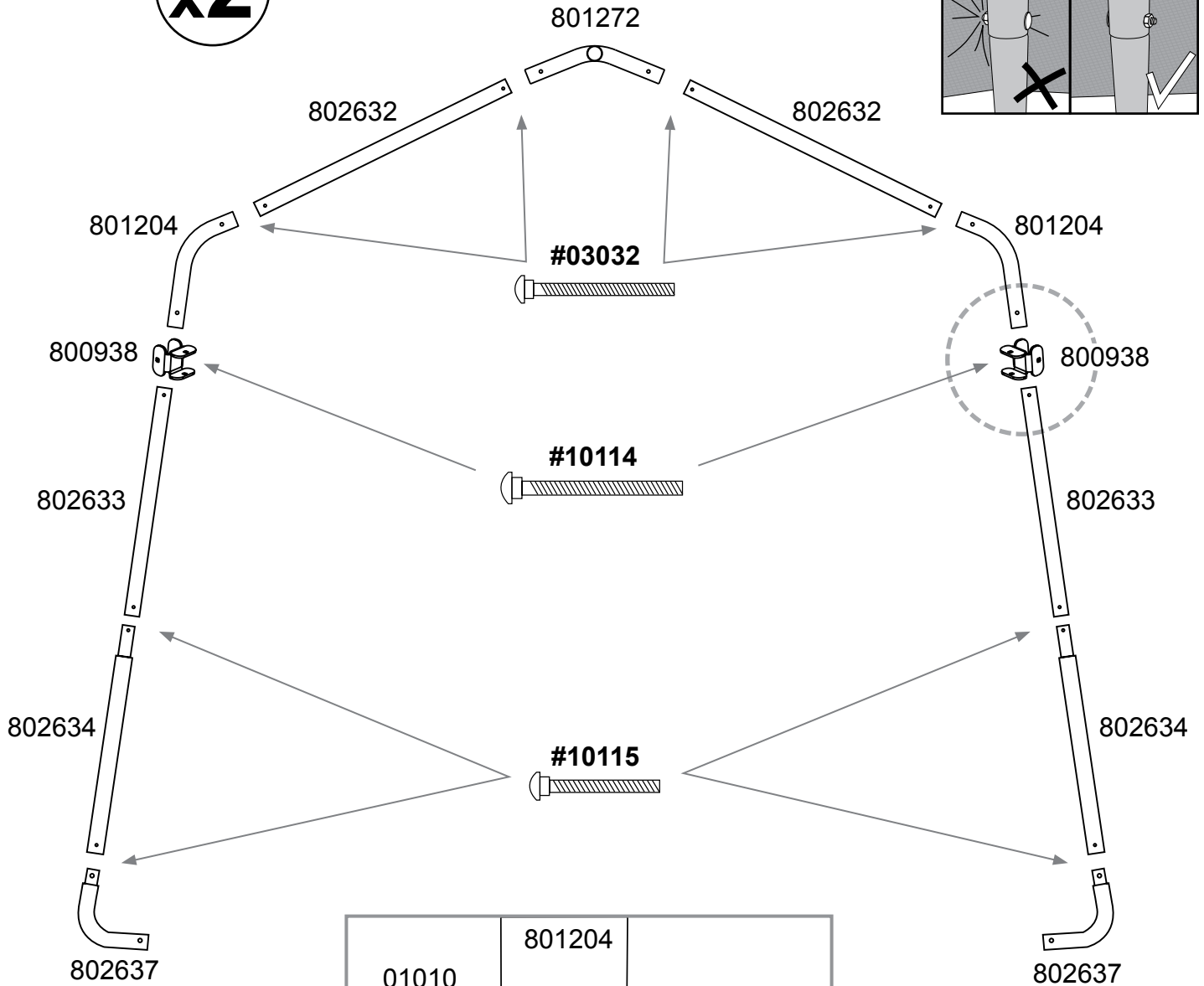

2.

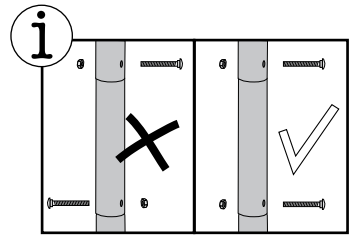
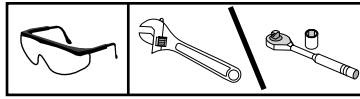

x1

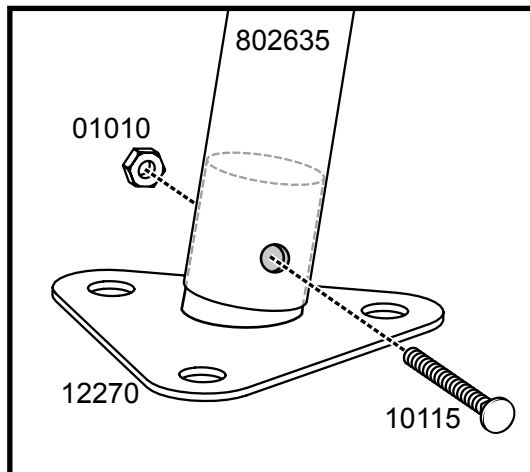
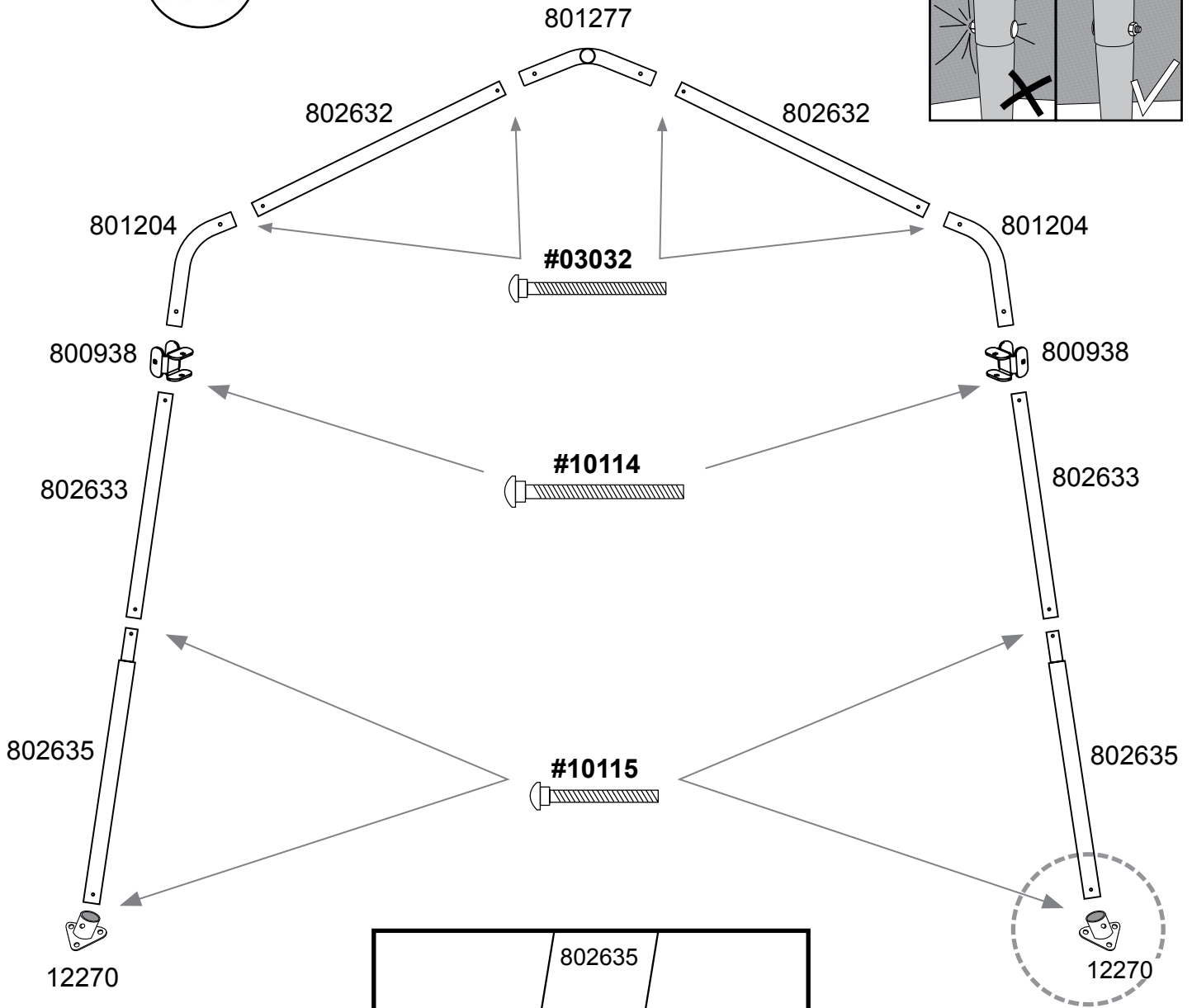
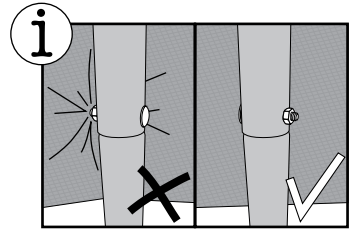

3.

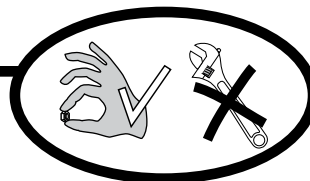
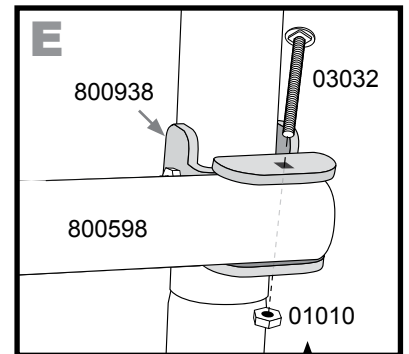
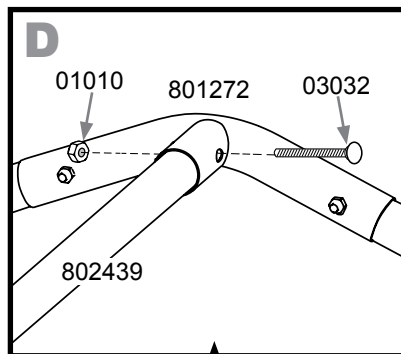
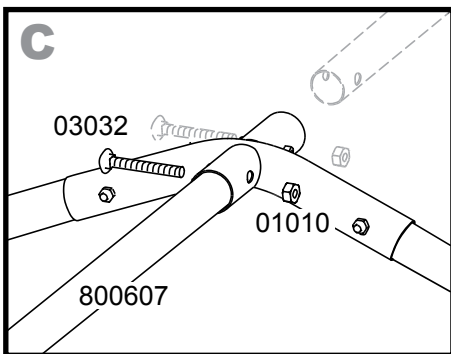
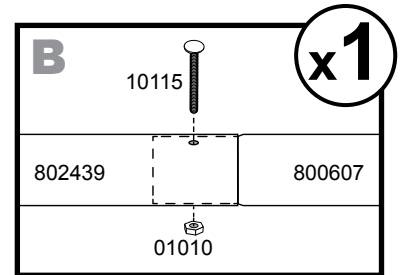
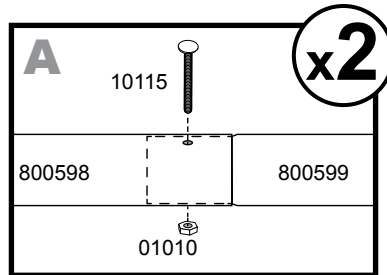
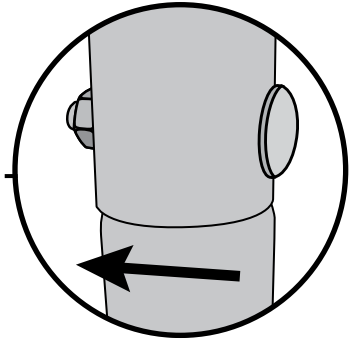
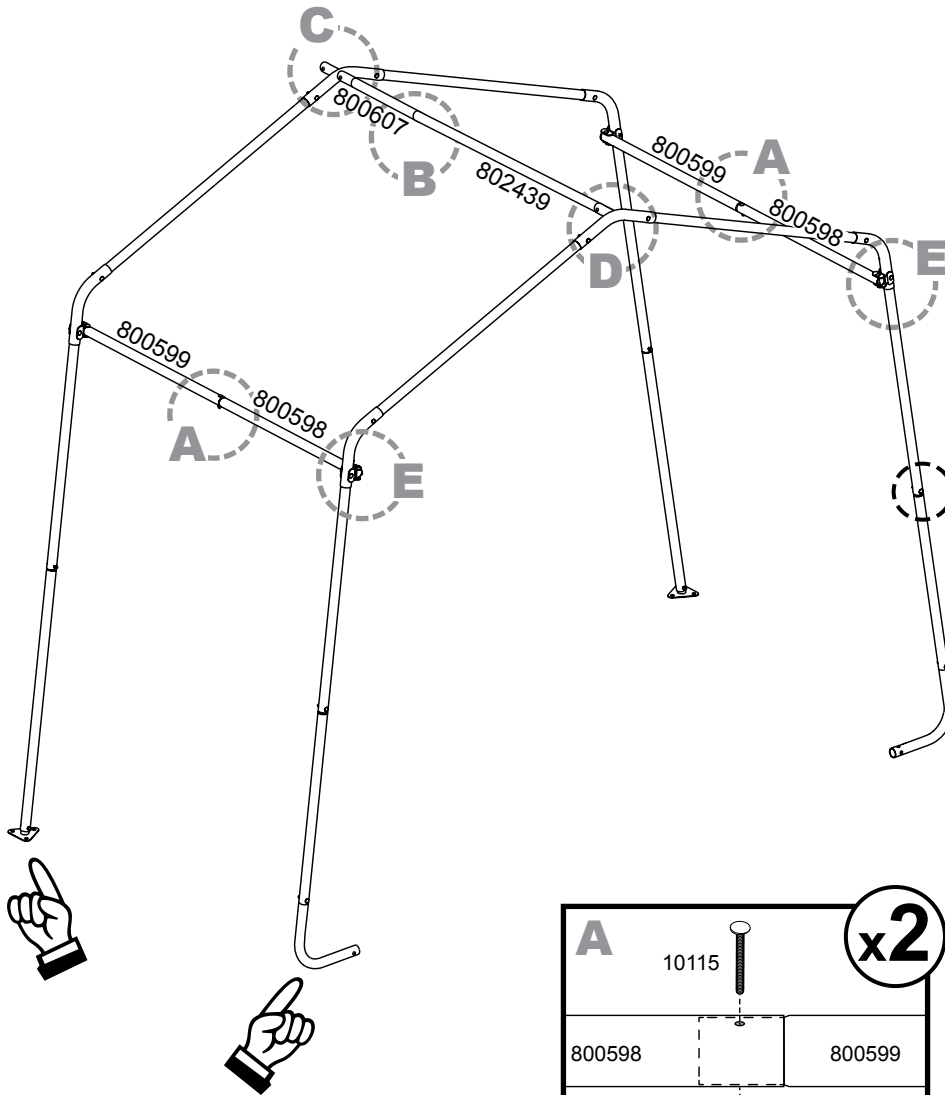
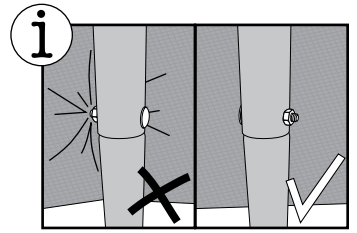
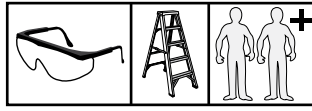

4.

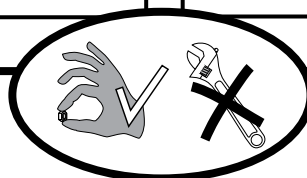
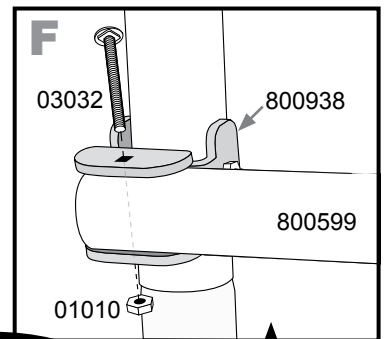
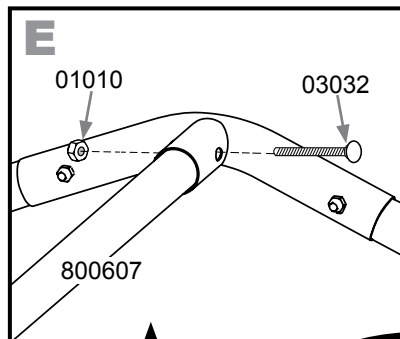
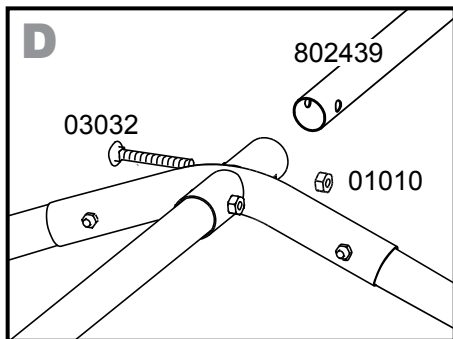
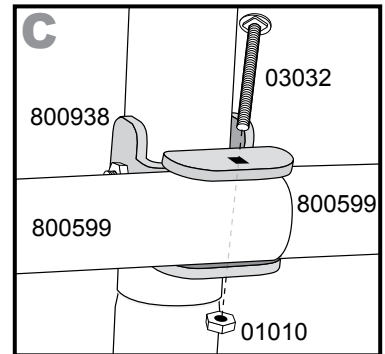
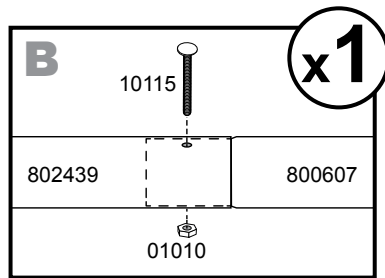
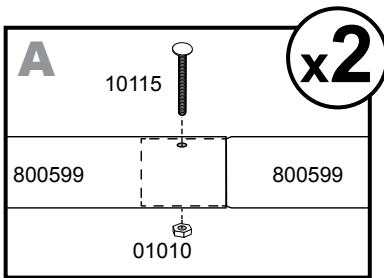
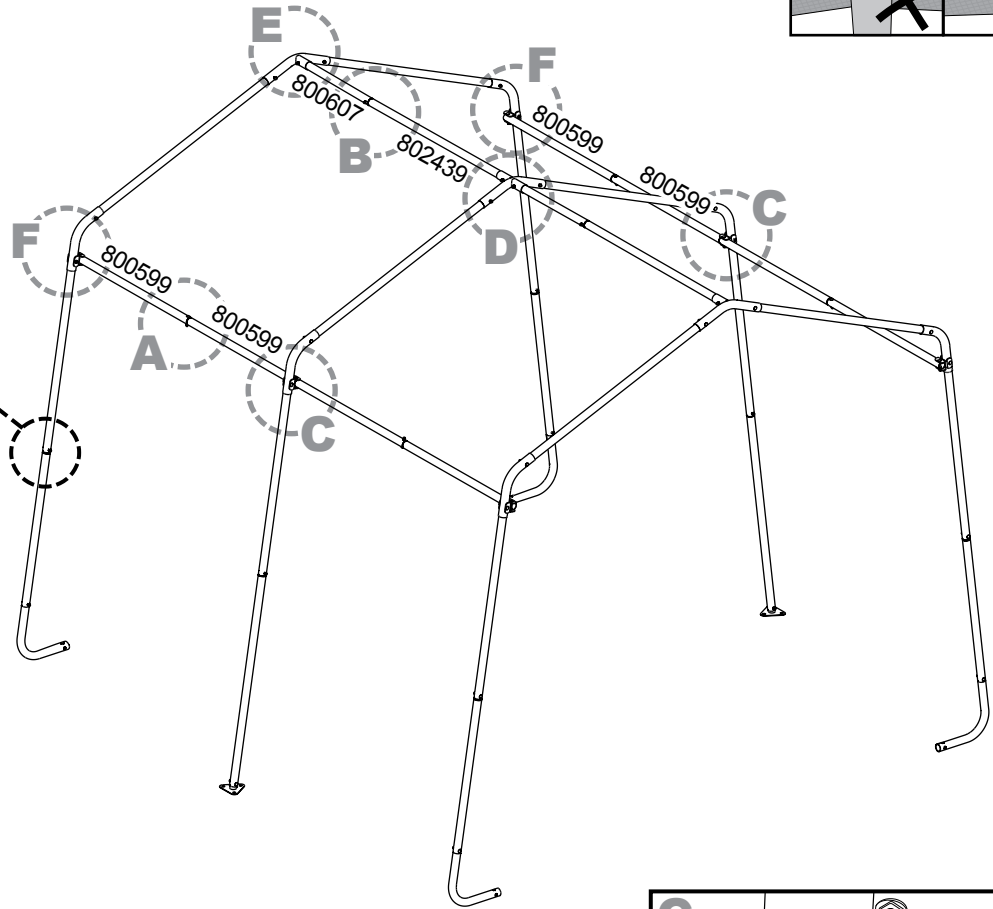
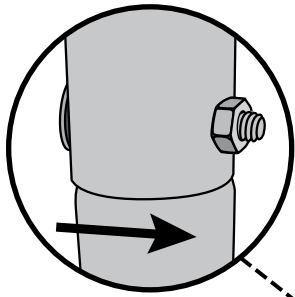
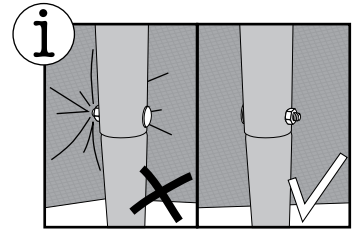
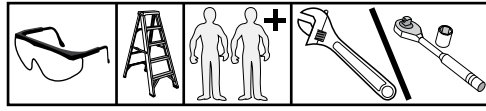

5.

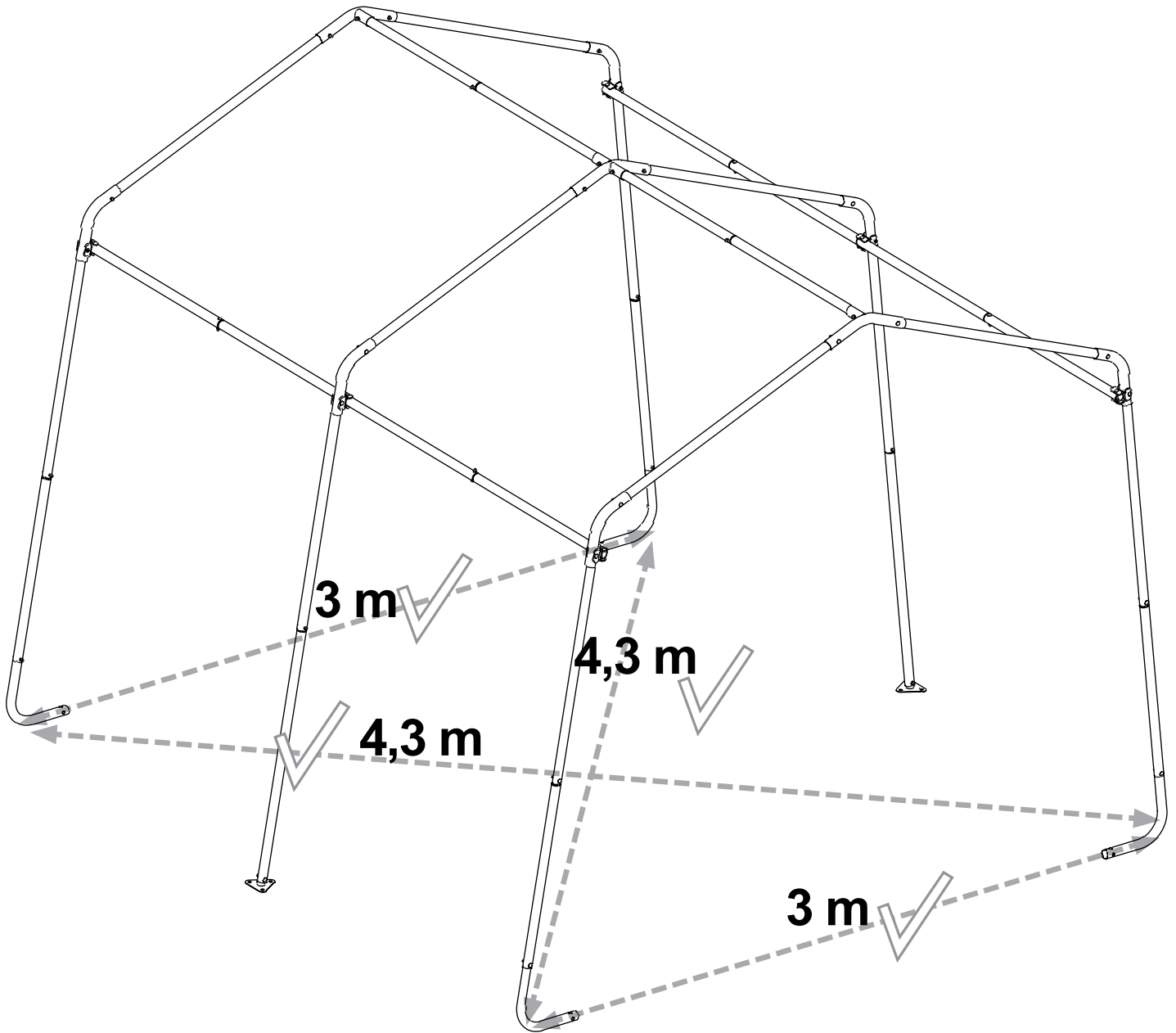
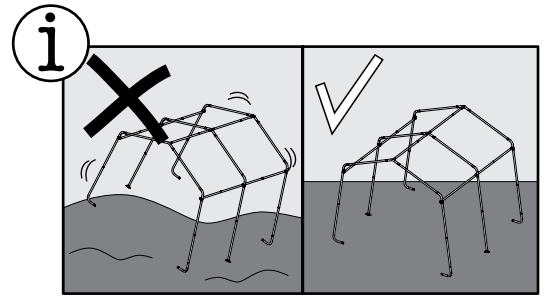
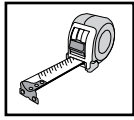

✓ ⊗ = ⊙
+/- 2,5 cm

6.

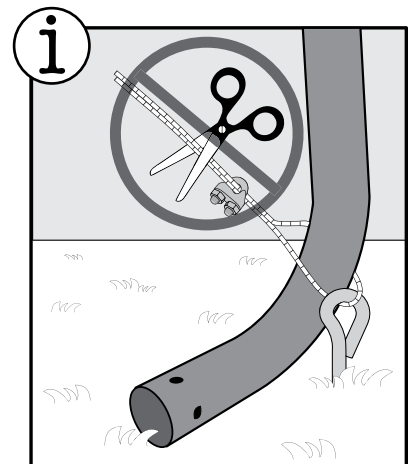
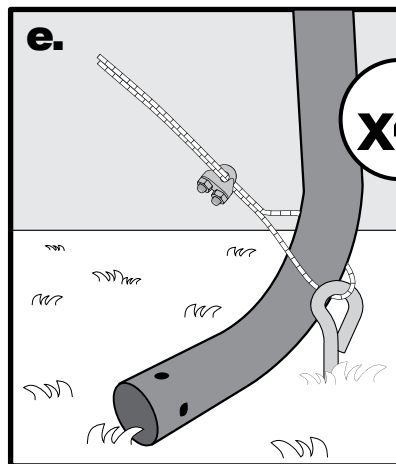
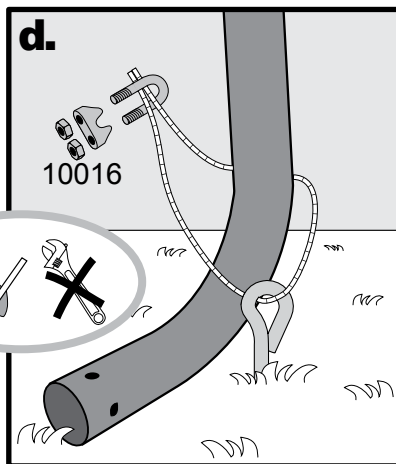
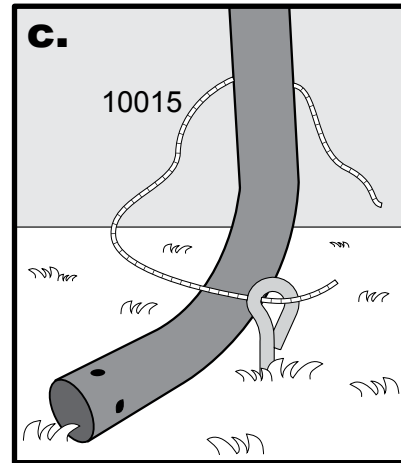
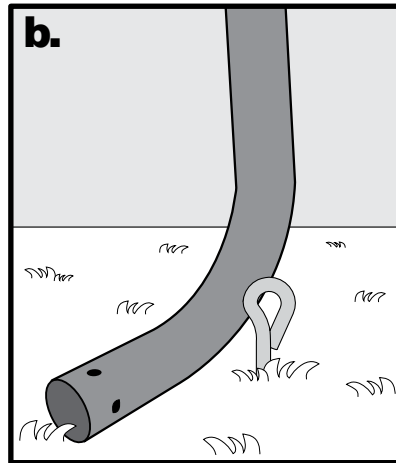
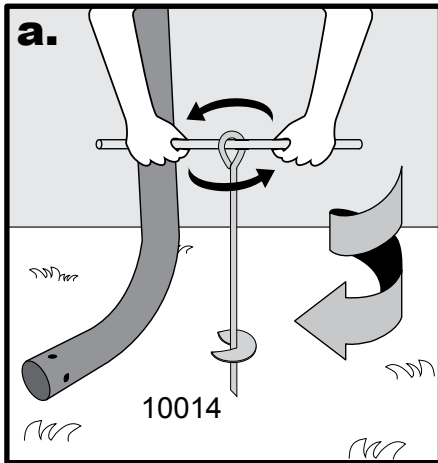
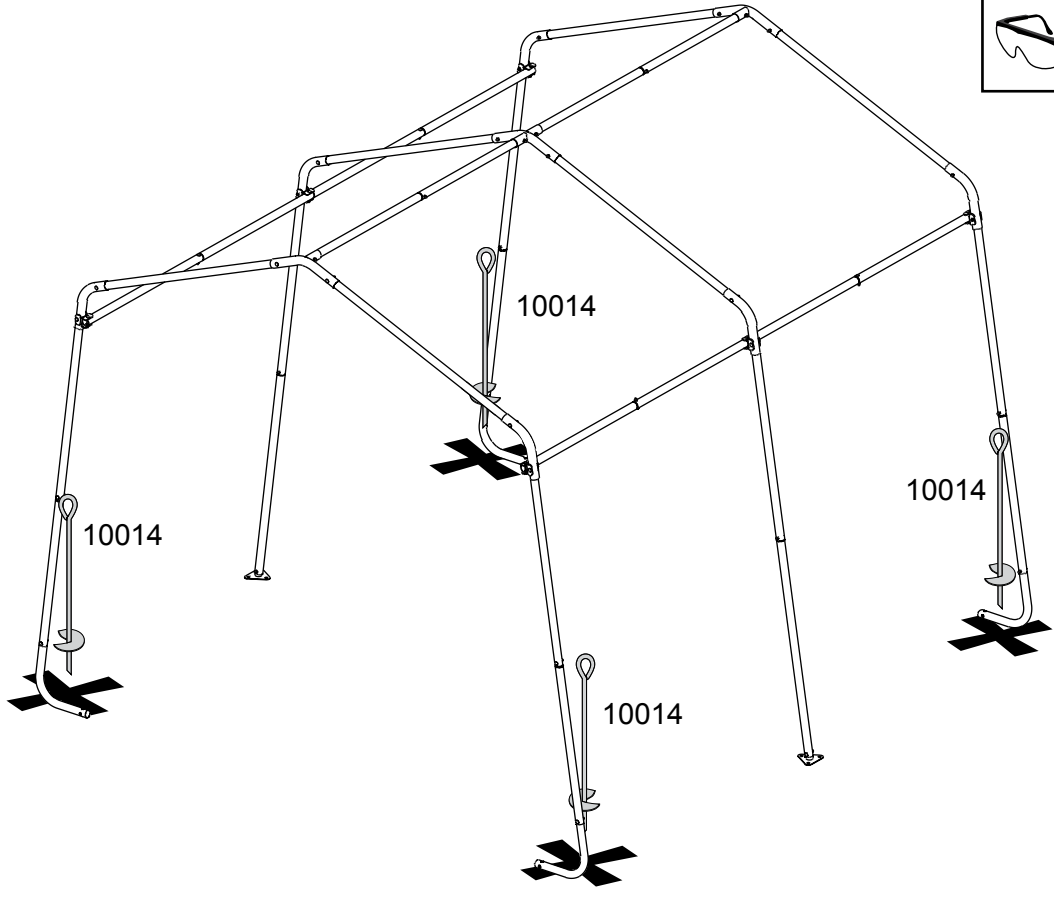
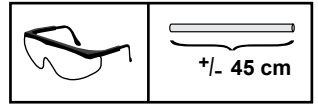

7.

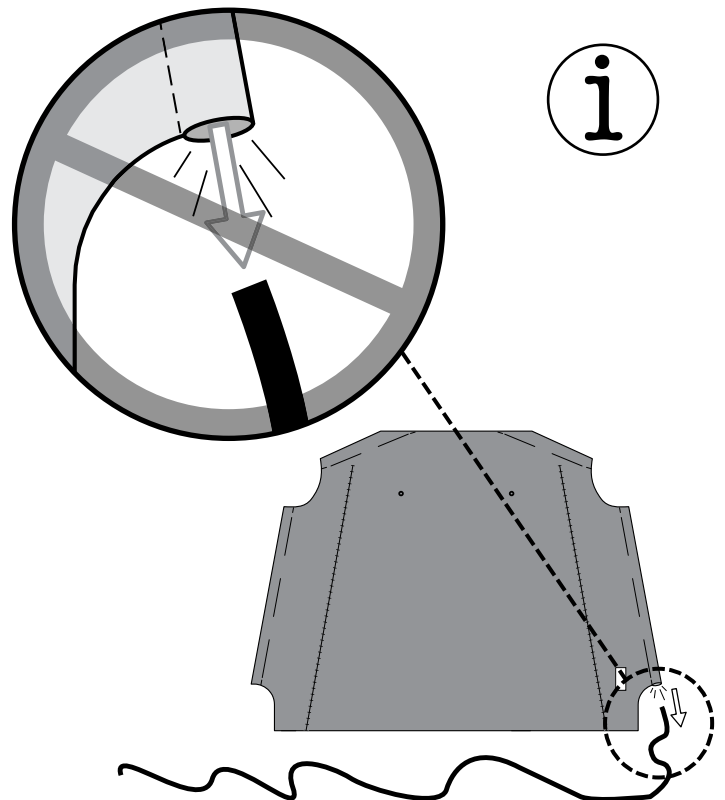
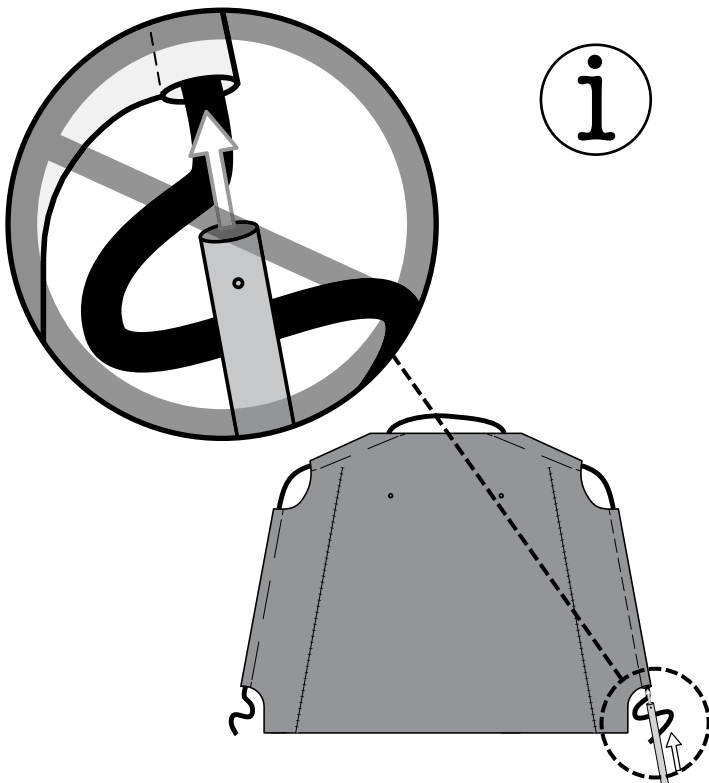
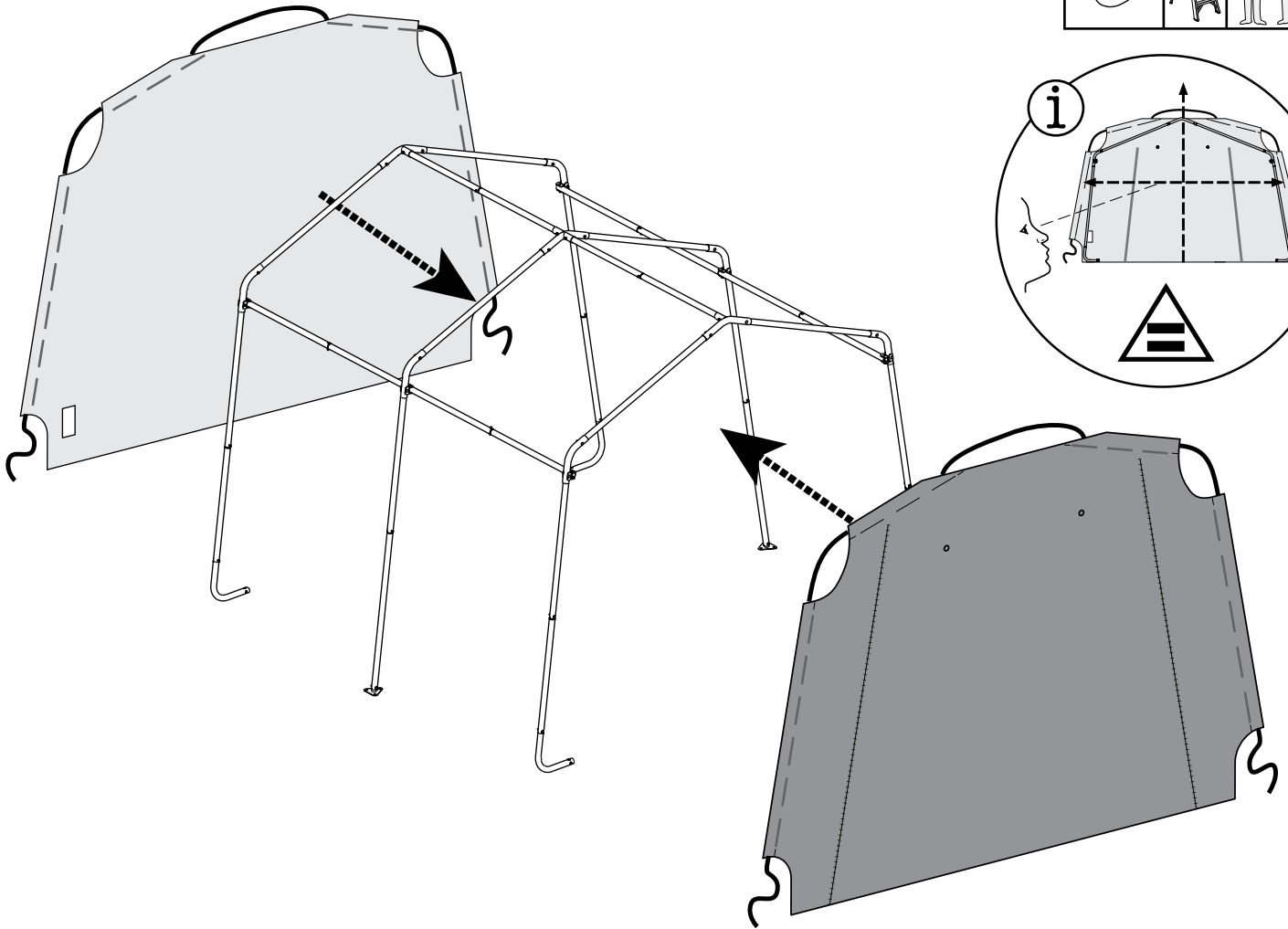
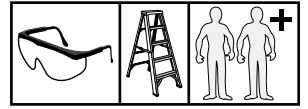

8.

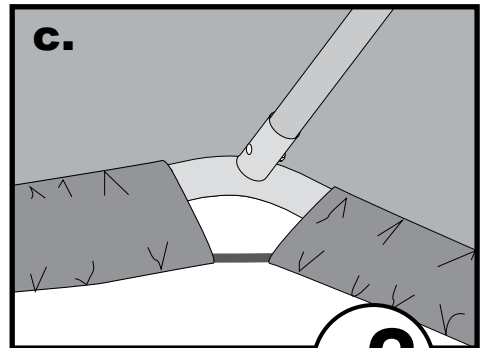
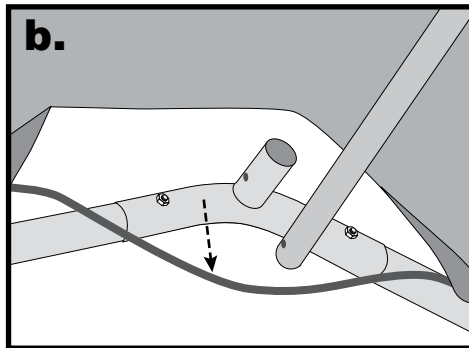
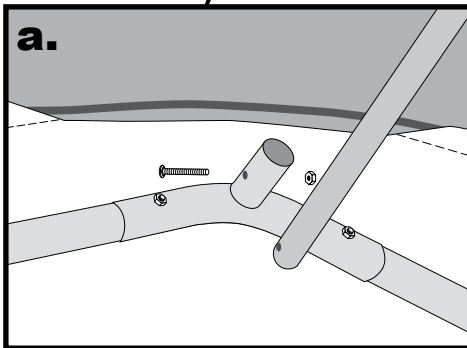
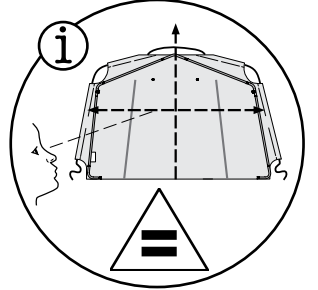
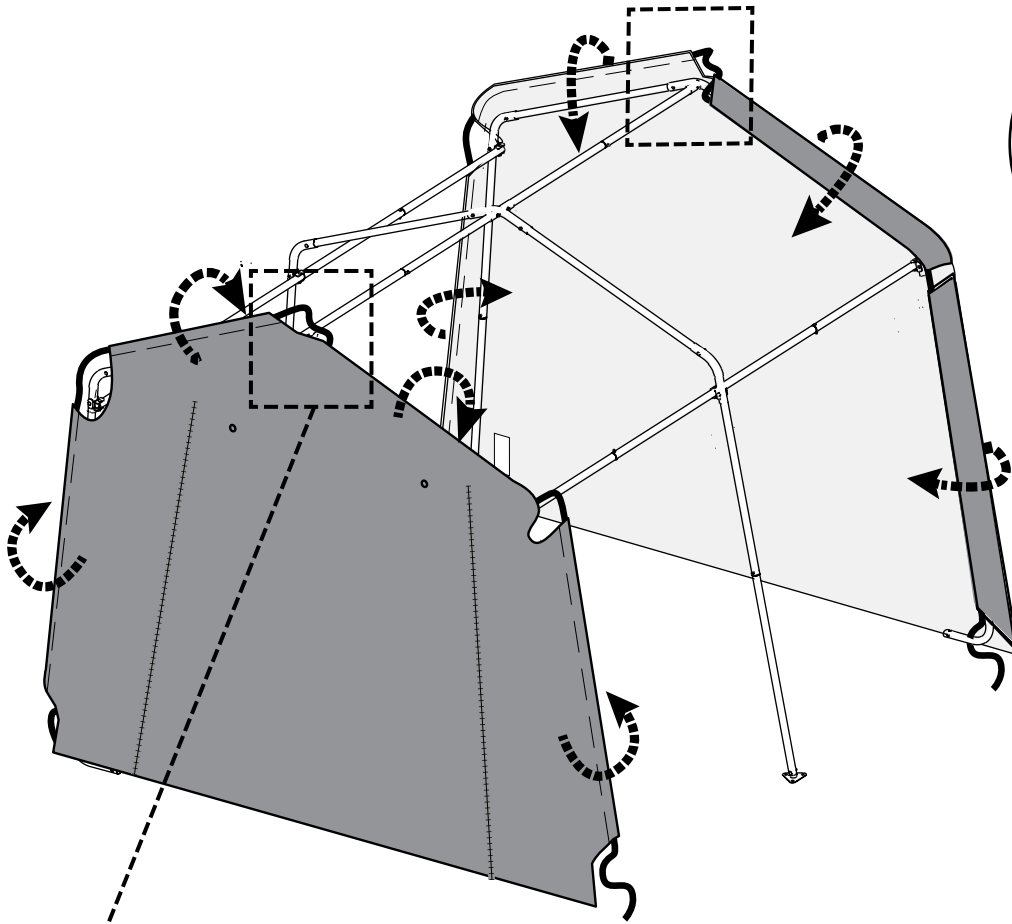
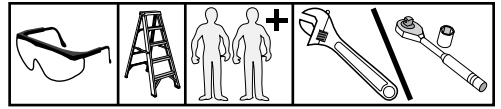

x2

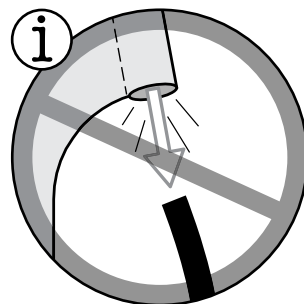
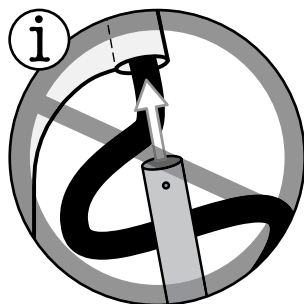

9.

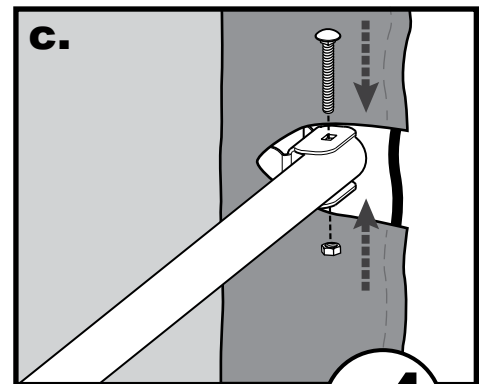
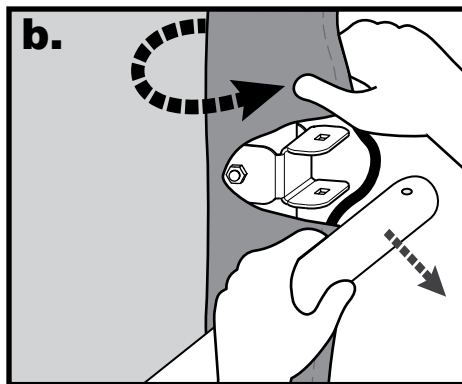
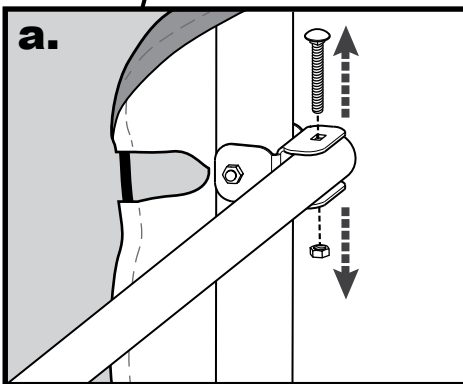
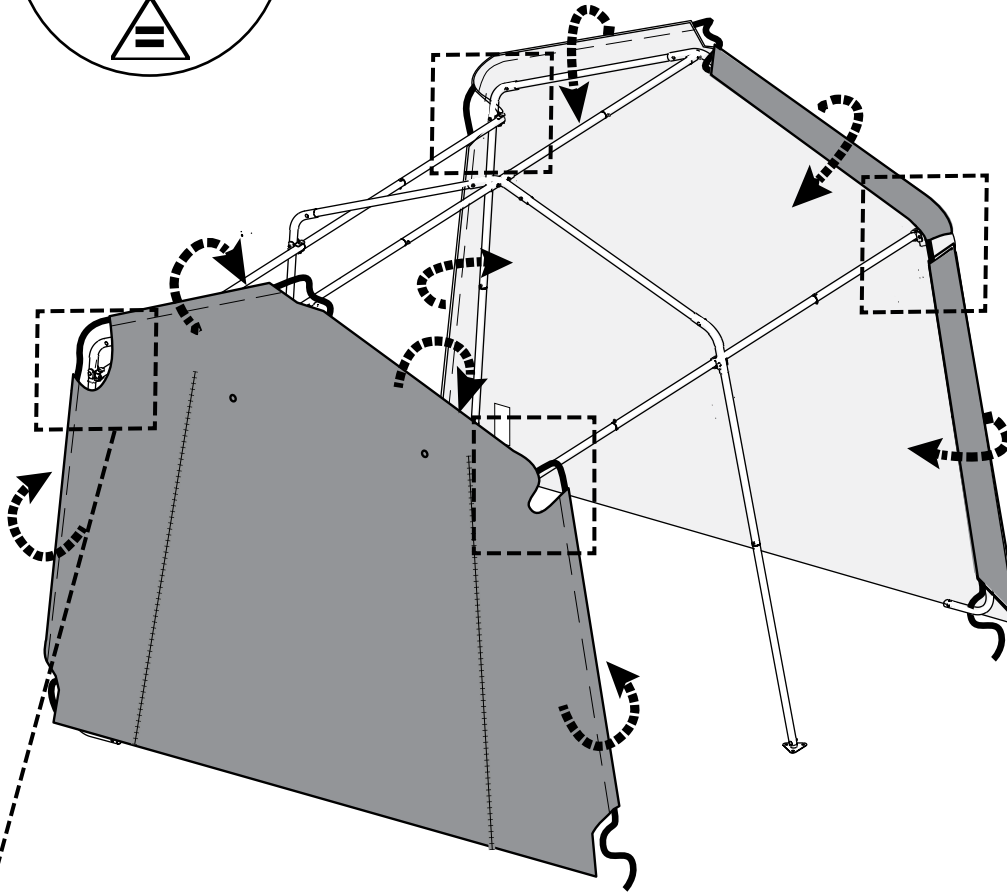
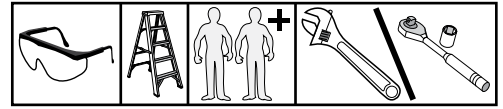
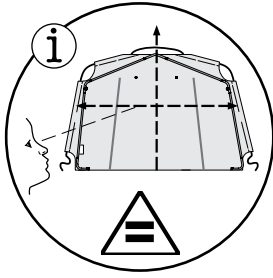

GB: Tool-tighten all connections after the installation of end panels.

DE: Ziehen Sie alle Verbindungen nach Montage der Endpaneele mit einem Werkzeug an.

FR: Serrez toutes les connexions avec un outil après installation des panneaux finaux.

SP: Apriete por medio de una herramienta todos los empalmes antes de instalar los paneles finales.

IT: Dopo l'installazione dei pannelli finali, serrare con un attrezzo idoneo tutti i collegamenti.

DT: Na het installeren van de eindpanelen, dienen alle verbindingen met behulp van gereedschap te worden aangehaald.

PT: Aperte todas as conexões depois da instalação das lonas terminais.

10.

a.

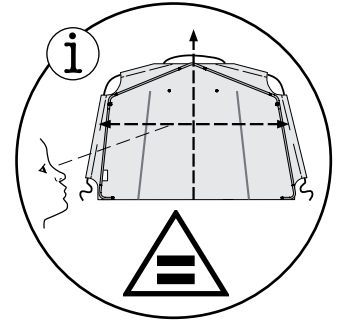
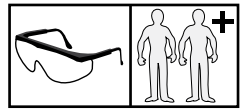
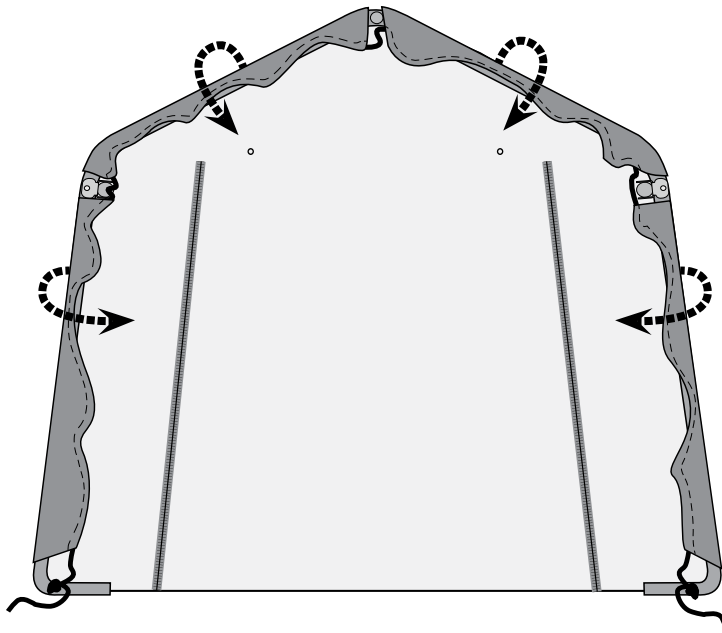

x2

b.

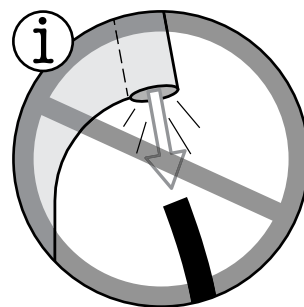
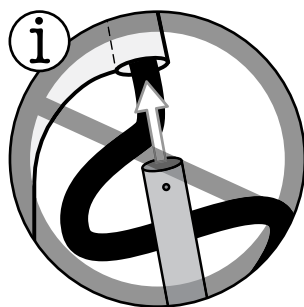
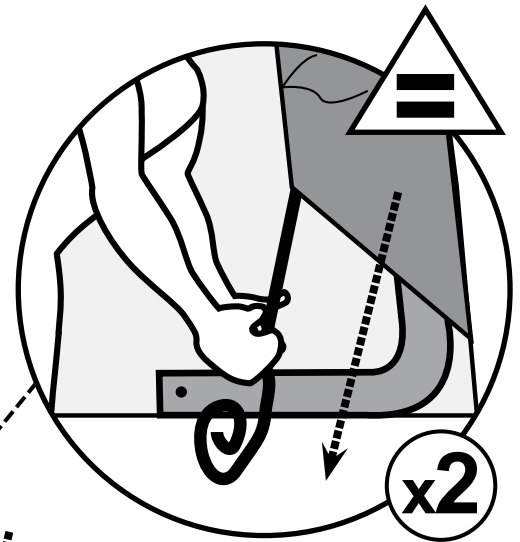
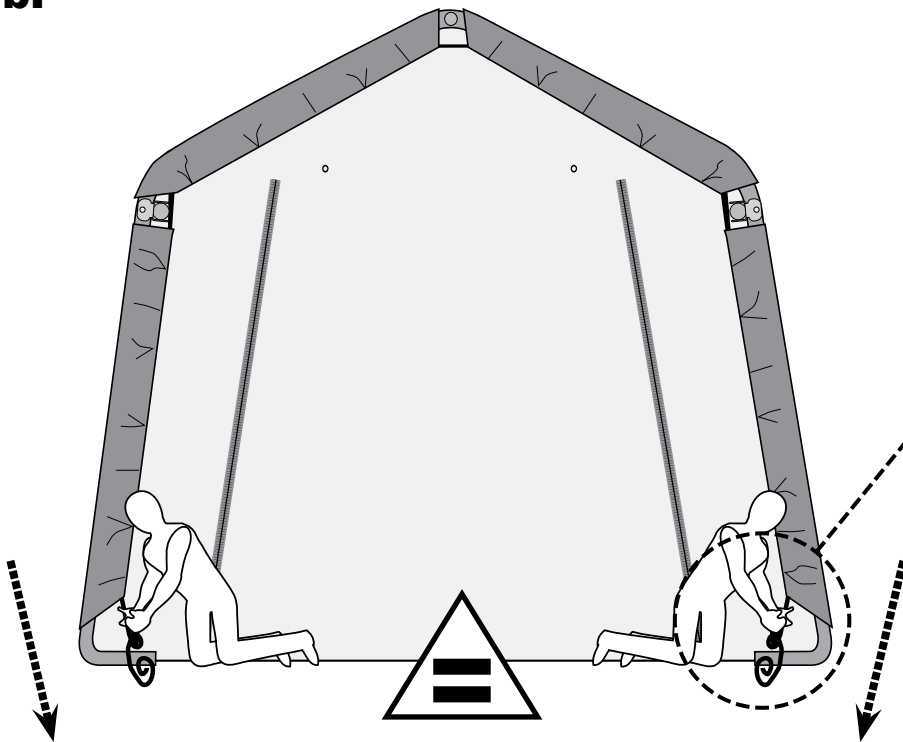

11.

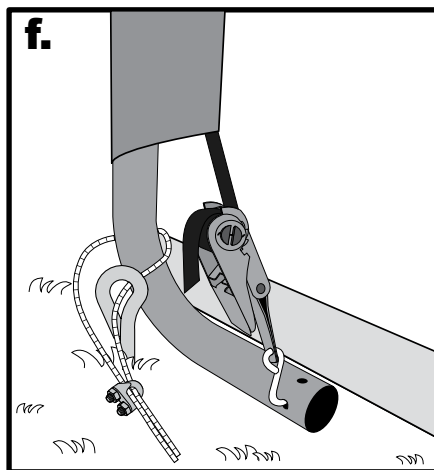
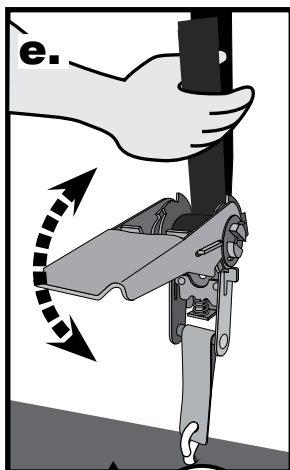
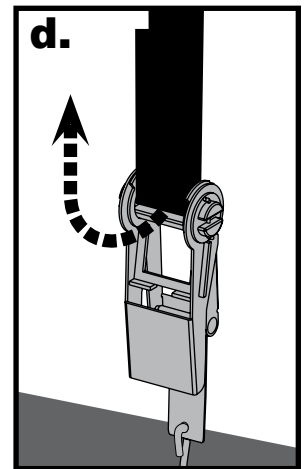
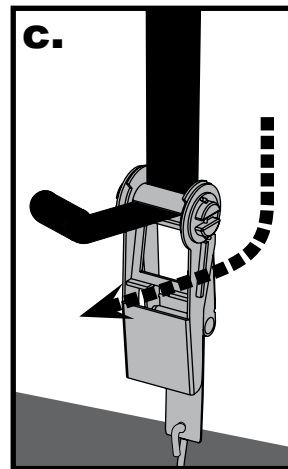
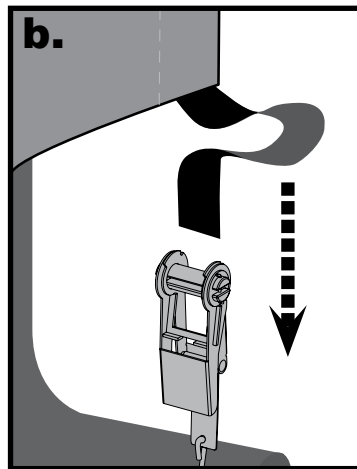
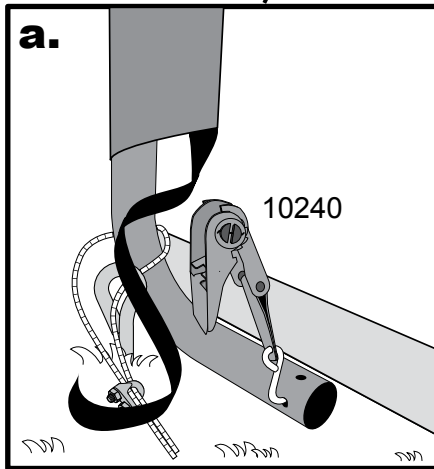
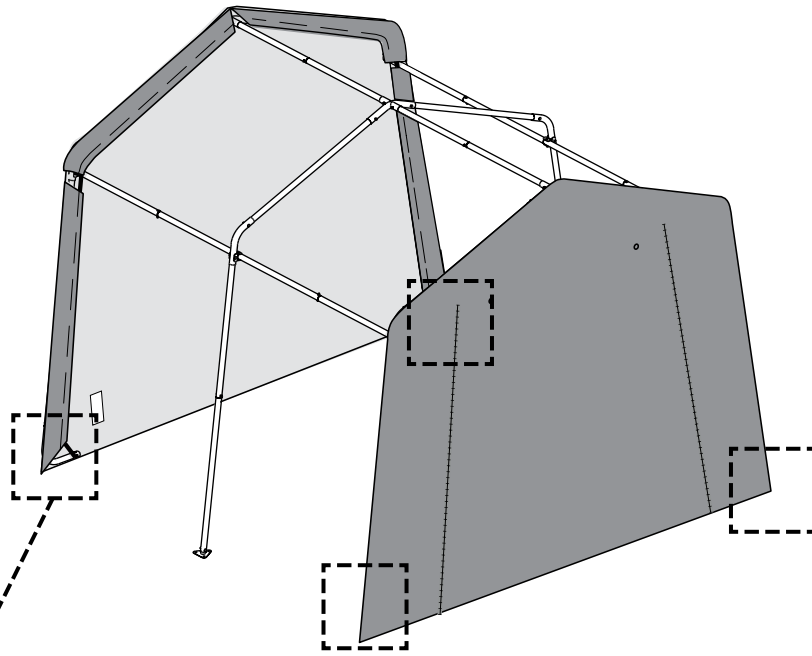
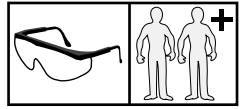

x4

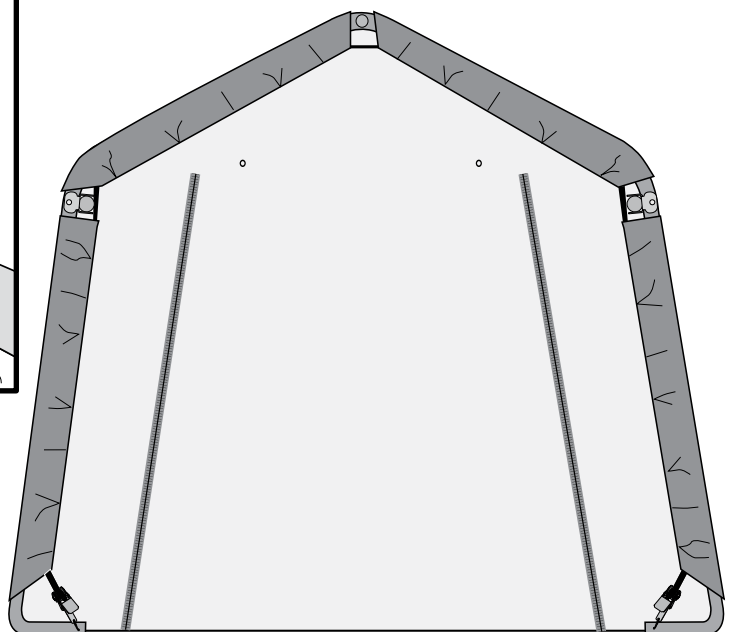

12.



a.

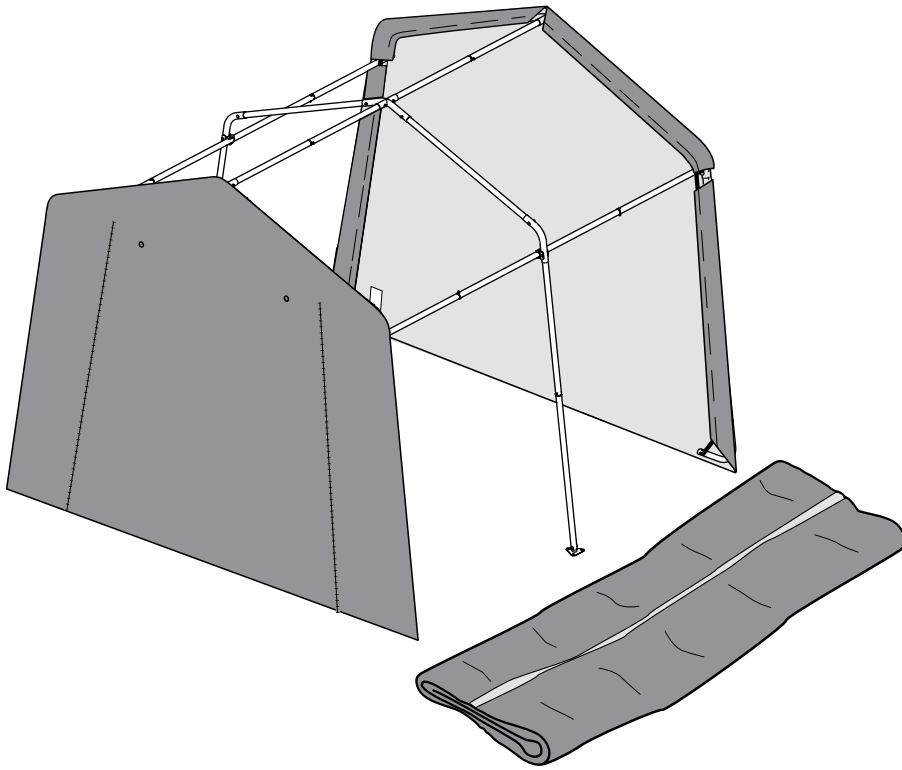

b.

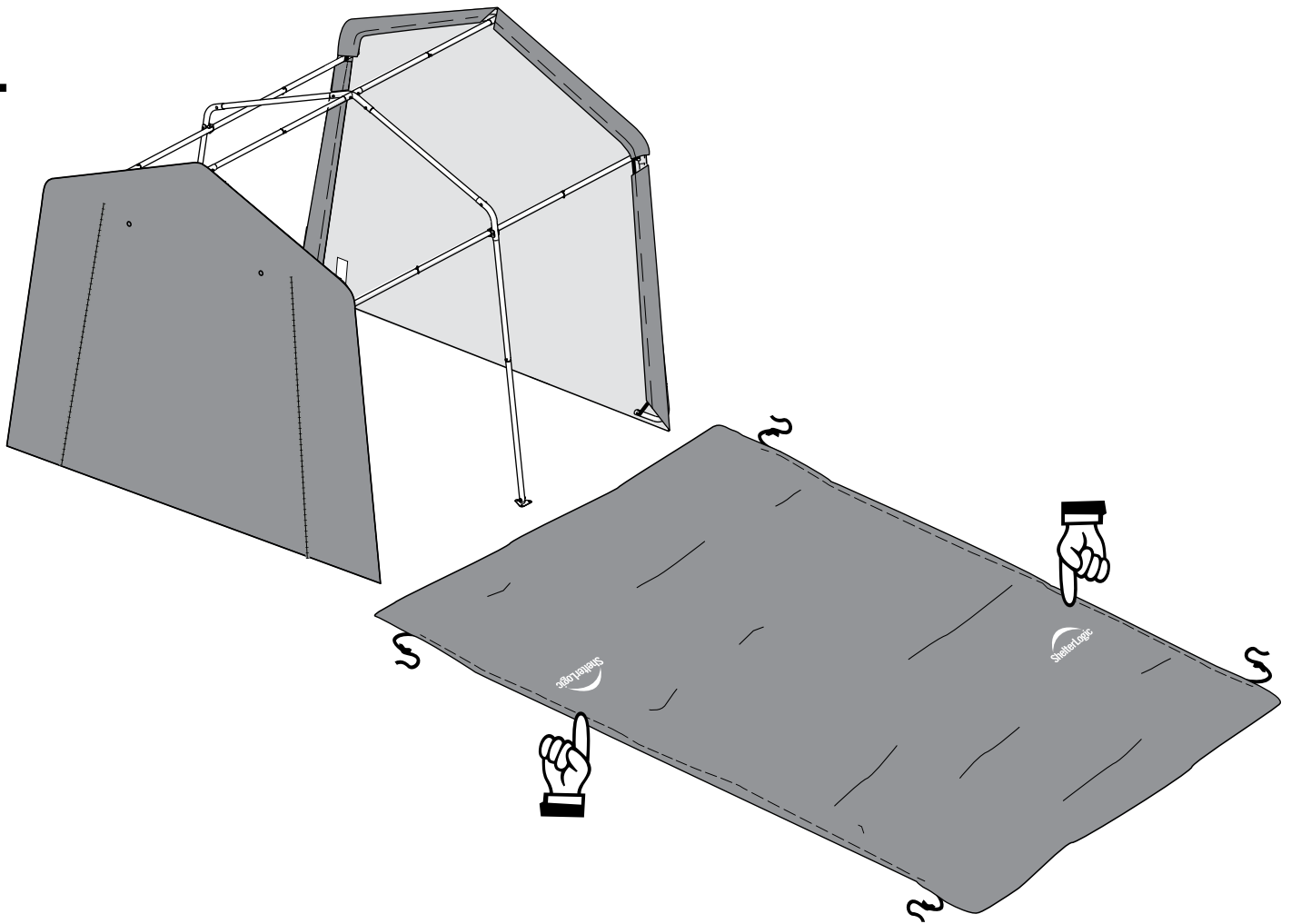

13.

a.

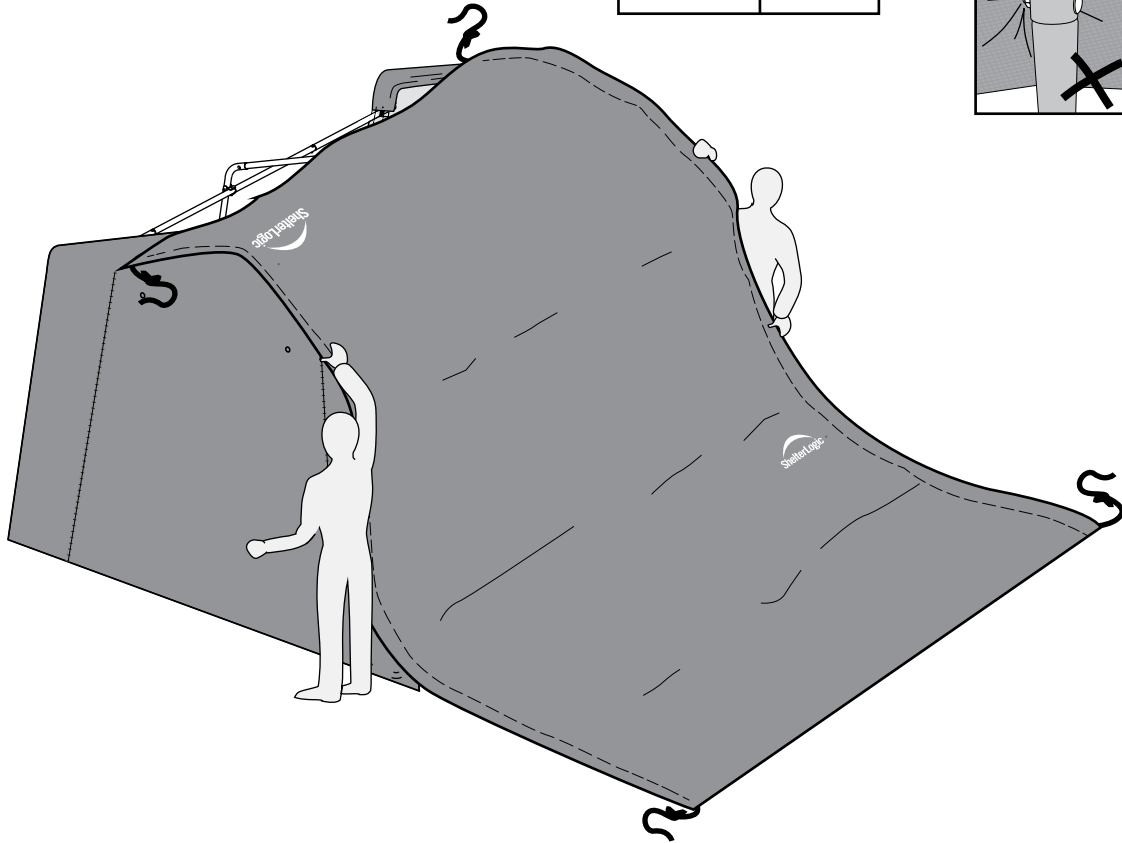
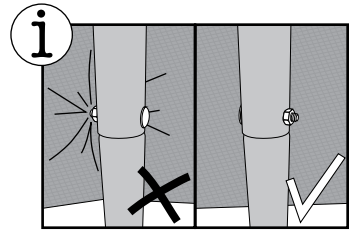
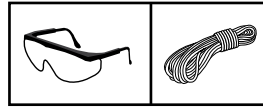

b.

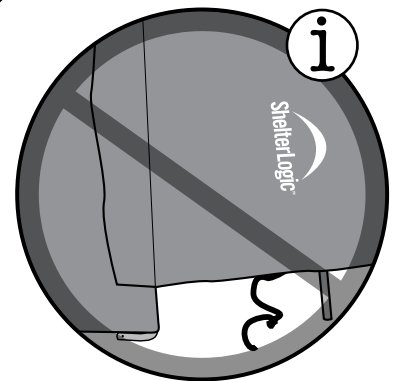
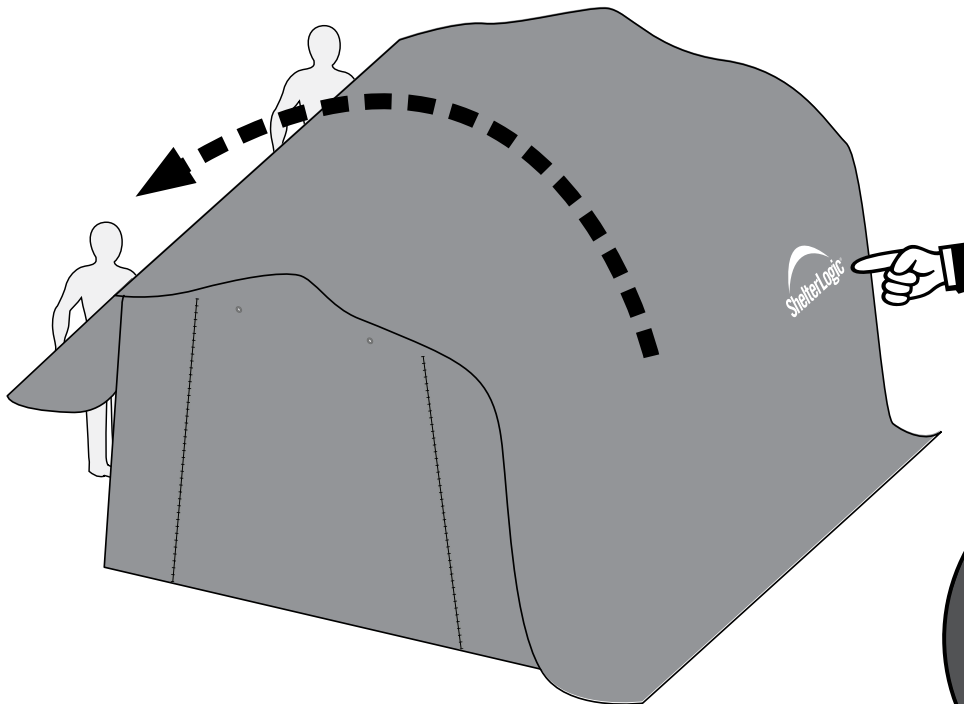

14.

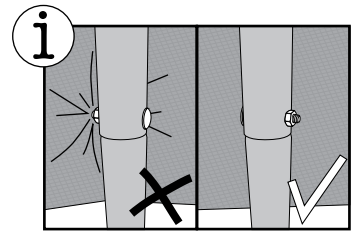
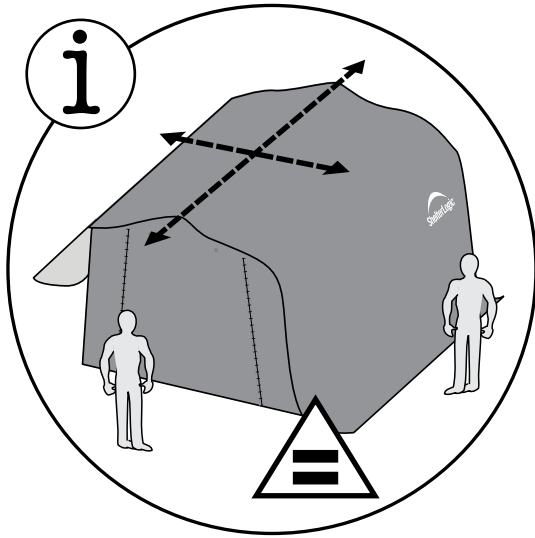

a.

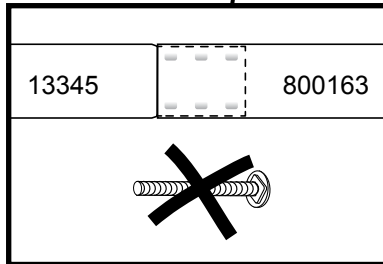
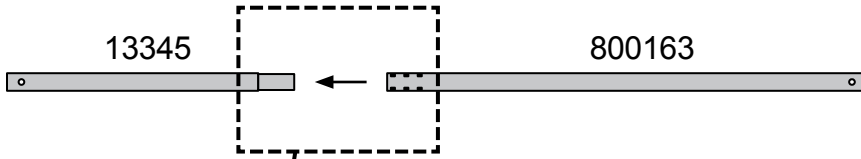

x4

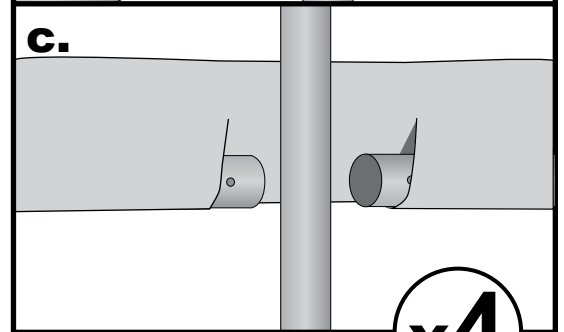
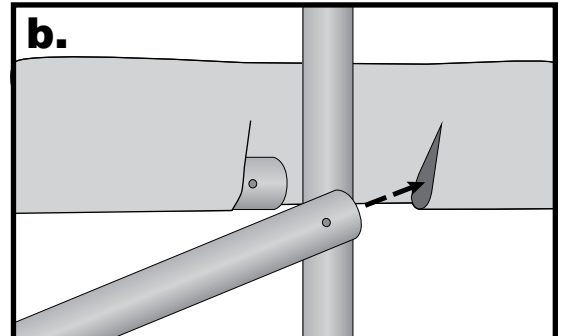

x4

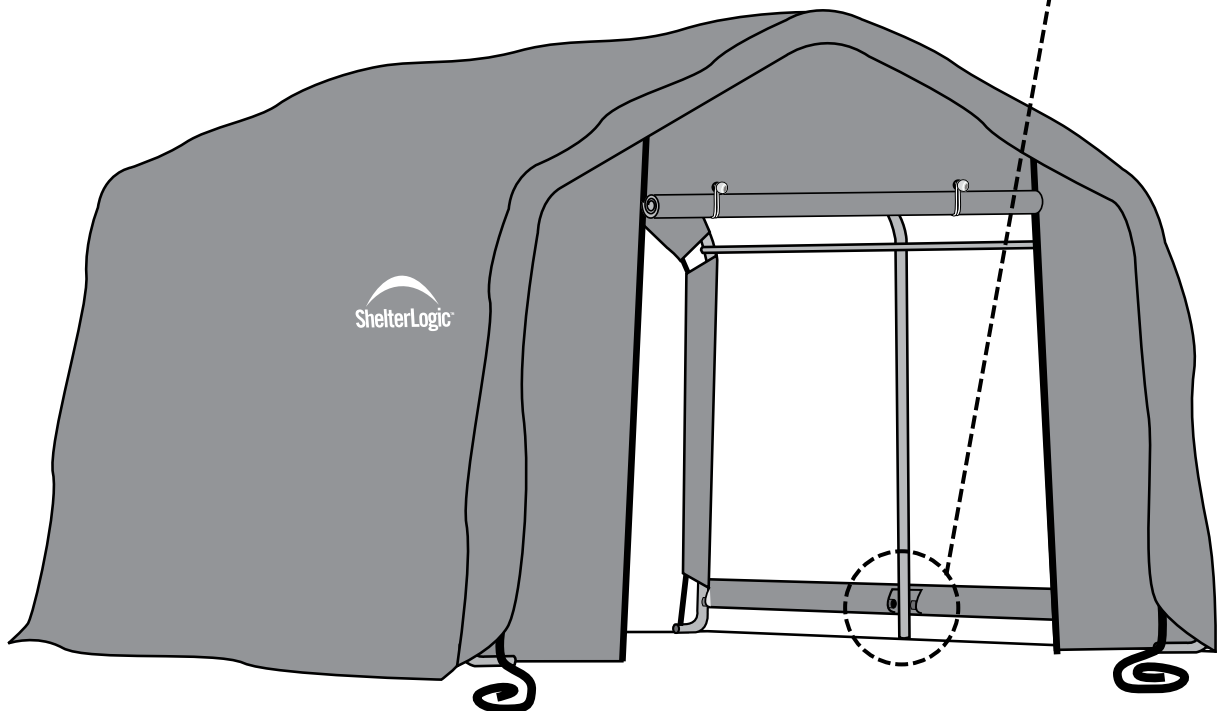

15.

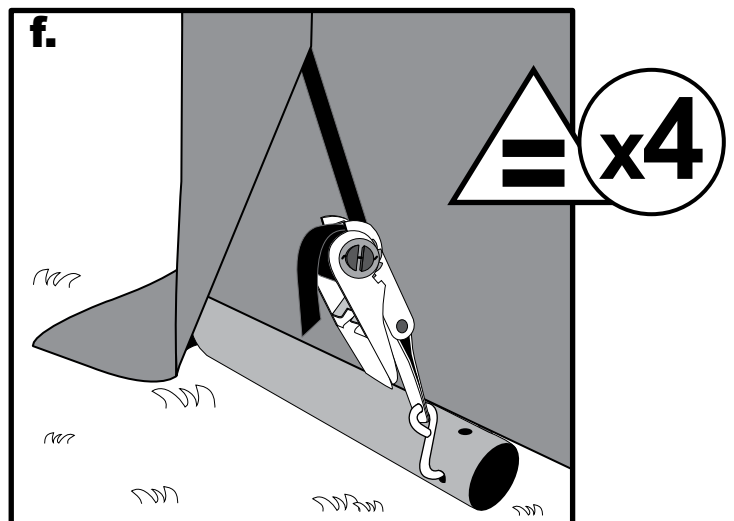
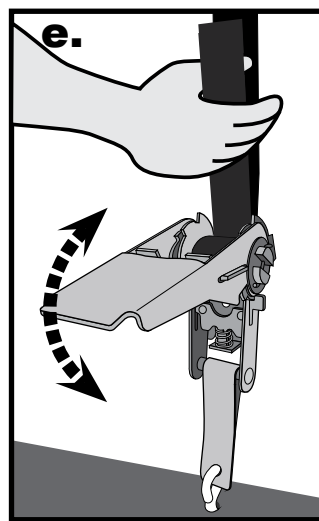
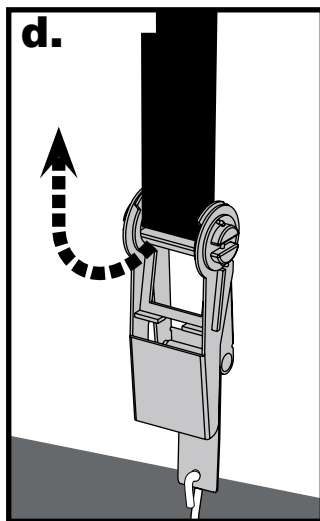
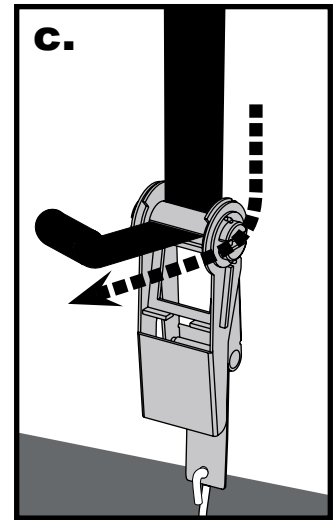
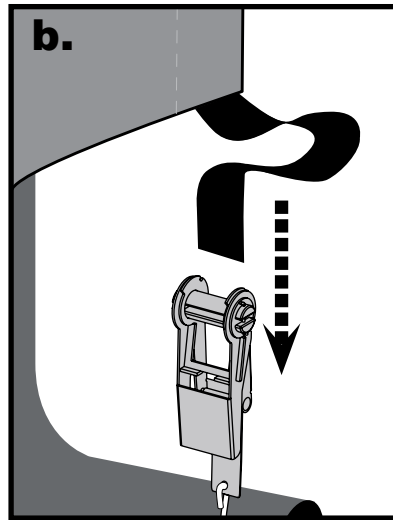
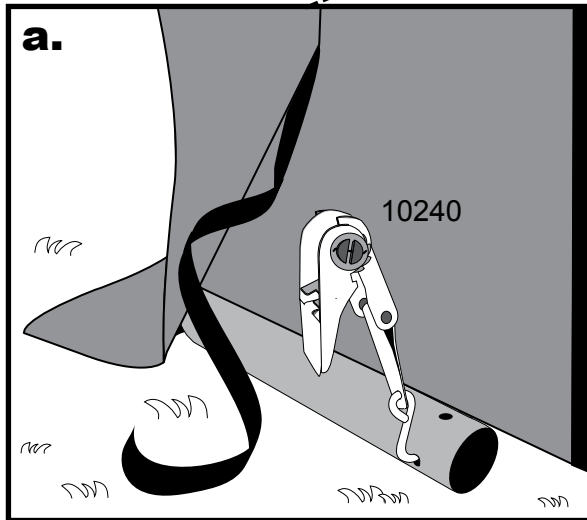
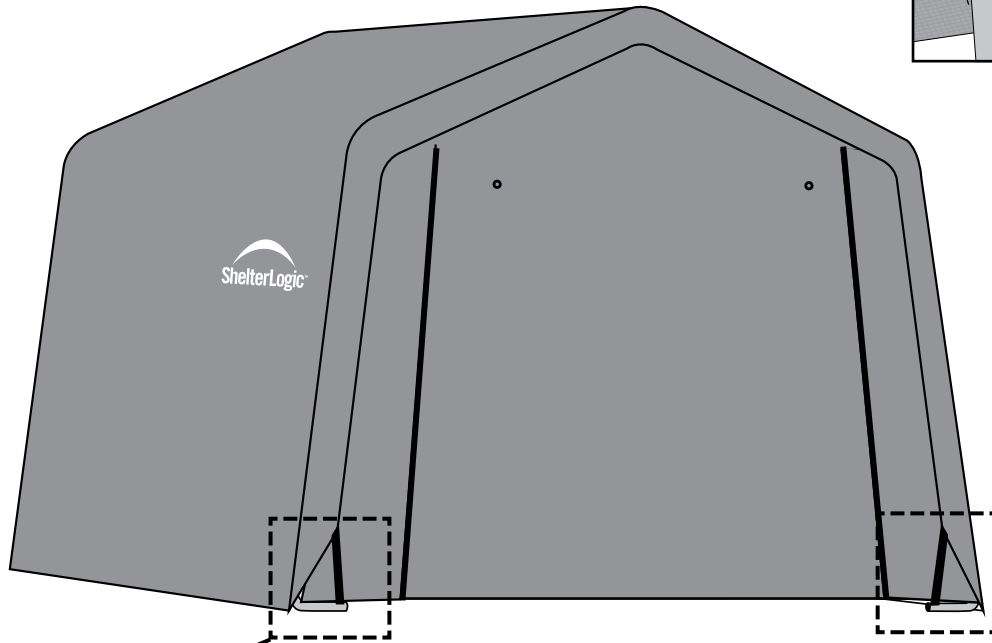
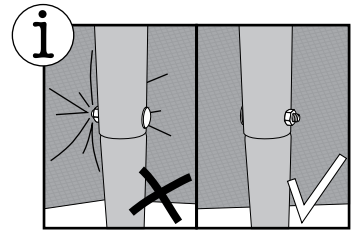
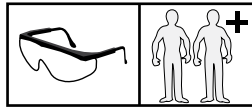

16.

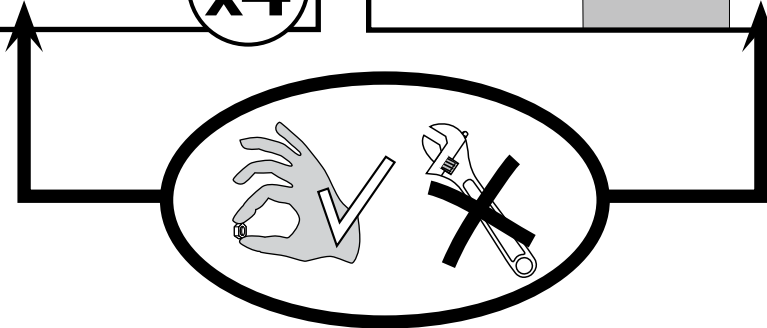
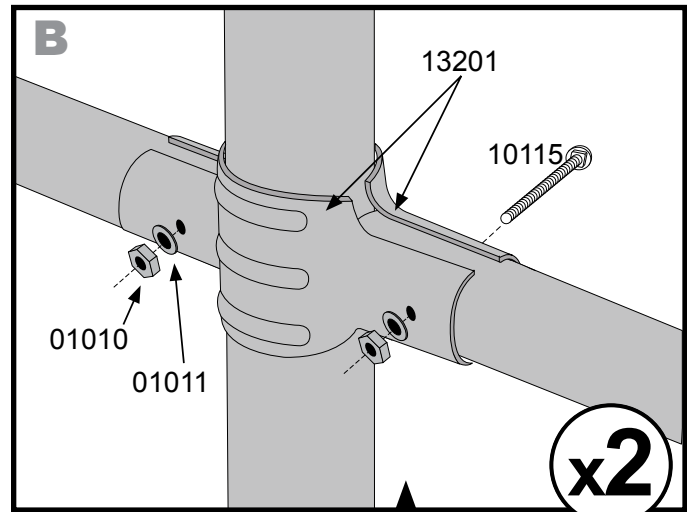
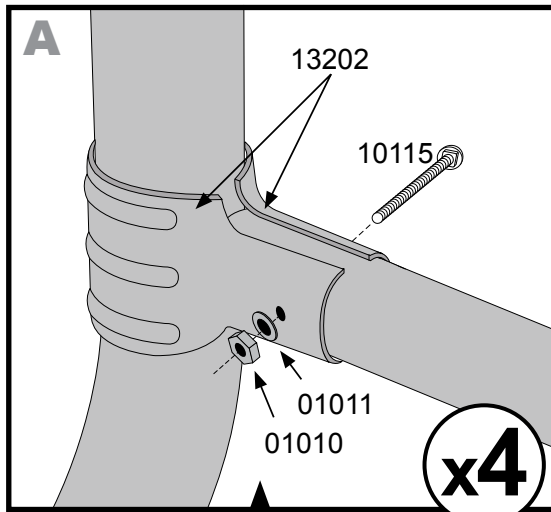
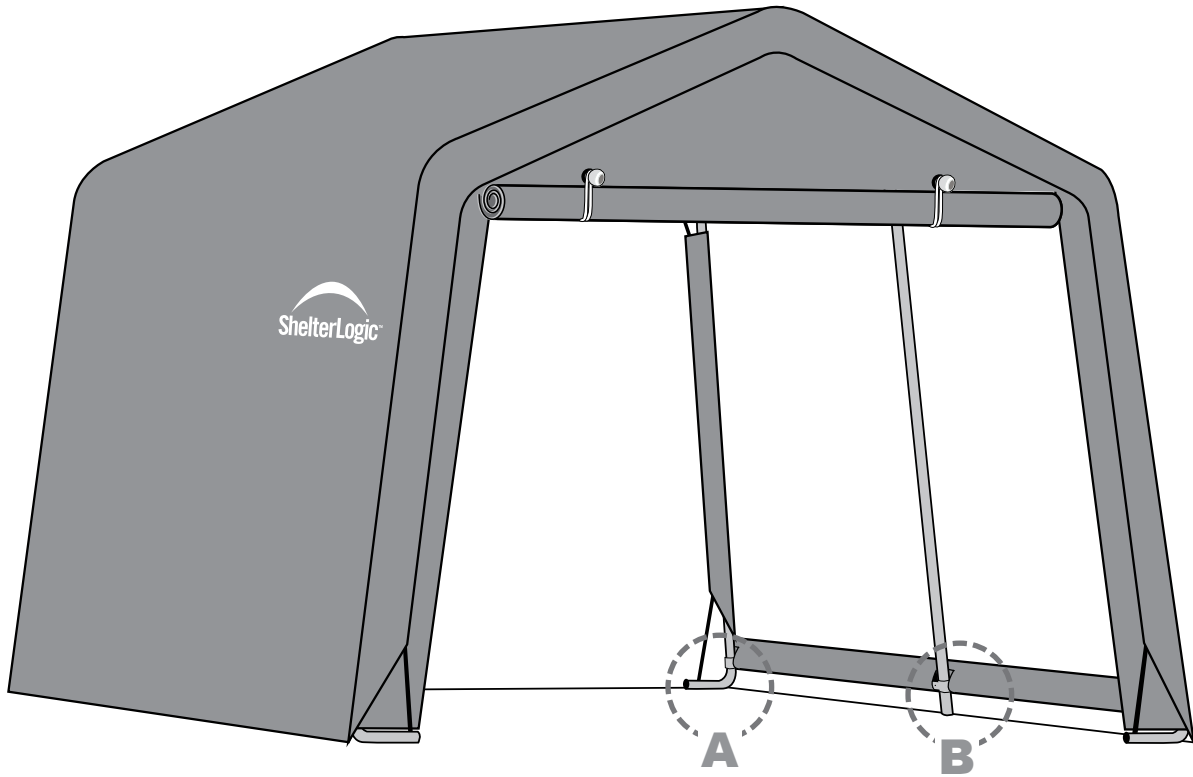
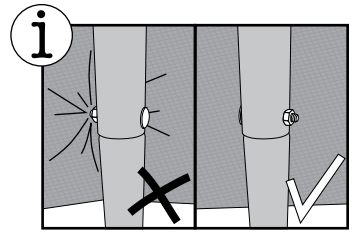
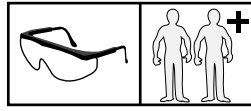

17.

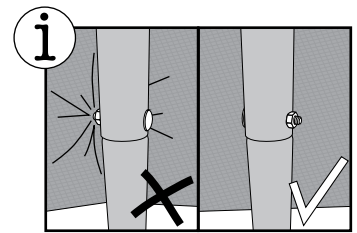
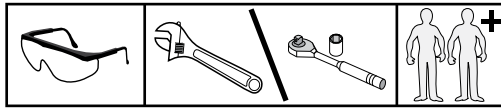

GB: To ensure longer cover life, check and retighten the cover every month.

DE: Um eine lange Lebensdauer der Plane zu gewährleisten, prüfen und spannen Sie die Plane monatlich.

FR: Pour assurer une bonne longévité de la couverture, vérifiez et resserrez la couverture tous les mois.

SP: Para asegurar una larga vida útil de la cubierta, revisela y reajústela cada mes.

IT: Per garantire una maggiore durata della copertura, controllare e serrare nuovamente la copertura a cadenza mensile.

DT: Voor een langere levensduur van het tentzeil dient u de bevestiging ervan iedere maand te controleren en indien nodig aan te spannen.

PT: Para aumentar a vida útil da lona, verifique e reaperte a amarração todos os meses.

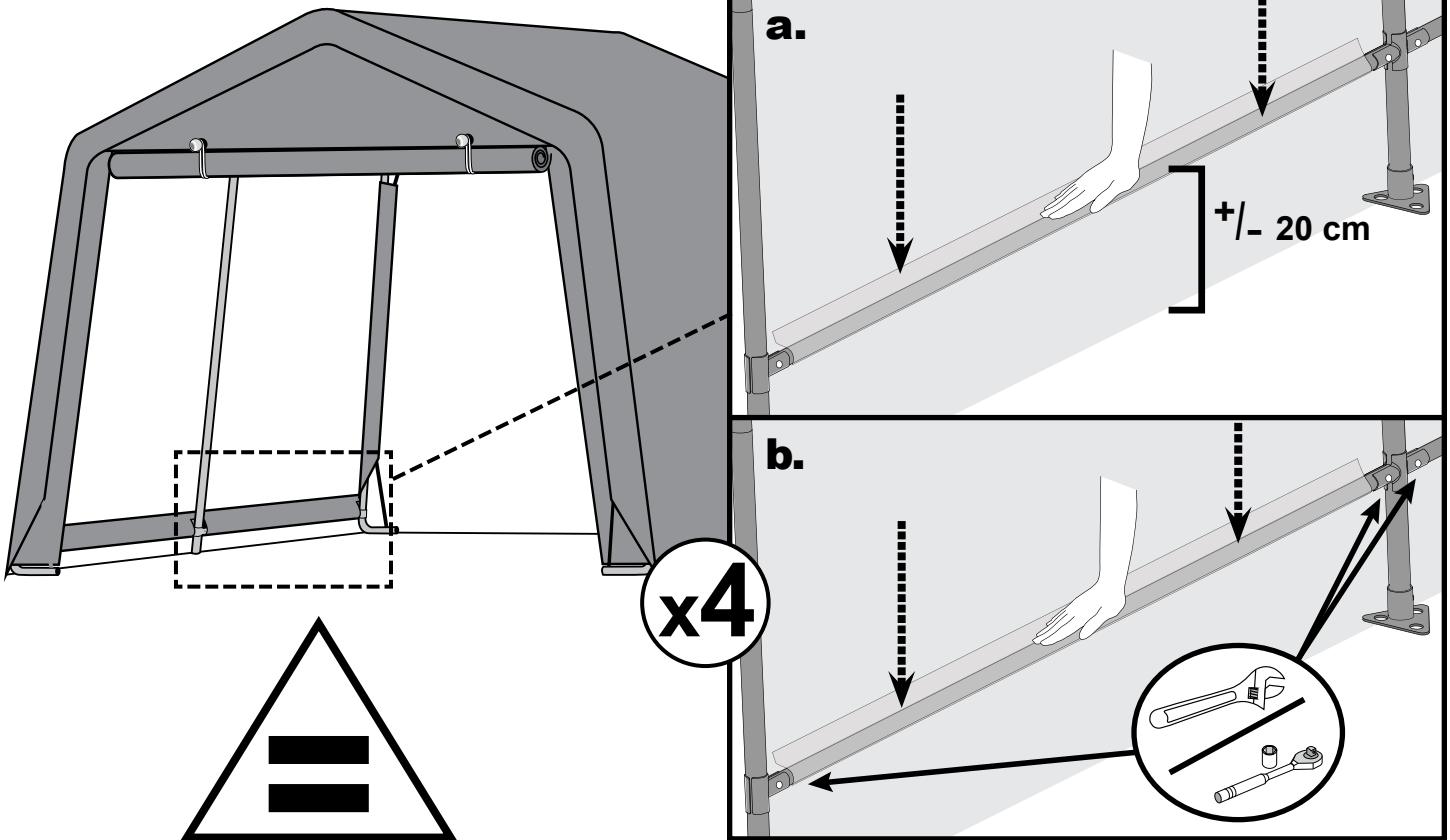

GB: Simultaneously tighten ratchets A & B, then C & D.

DE: Spannen Sie hierzu zunächst gleichzeitig die Ratschen A & B, dann C & D.

FR: Serrez simultanément les cliquets A & B, puis C & D.

SP: Ajuste simultáneamente los trinquetes A y B y, a continuación, el C y el D.

IT: Serrare simultaneamente i fermi A e B, quindi C e D.

DT: Haal tegelijkertijd de ratels A & B aan en vervolgens C & D.

PT: Aperte ao mesmo tempo os trinquetes A e B e depois C e D.

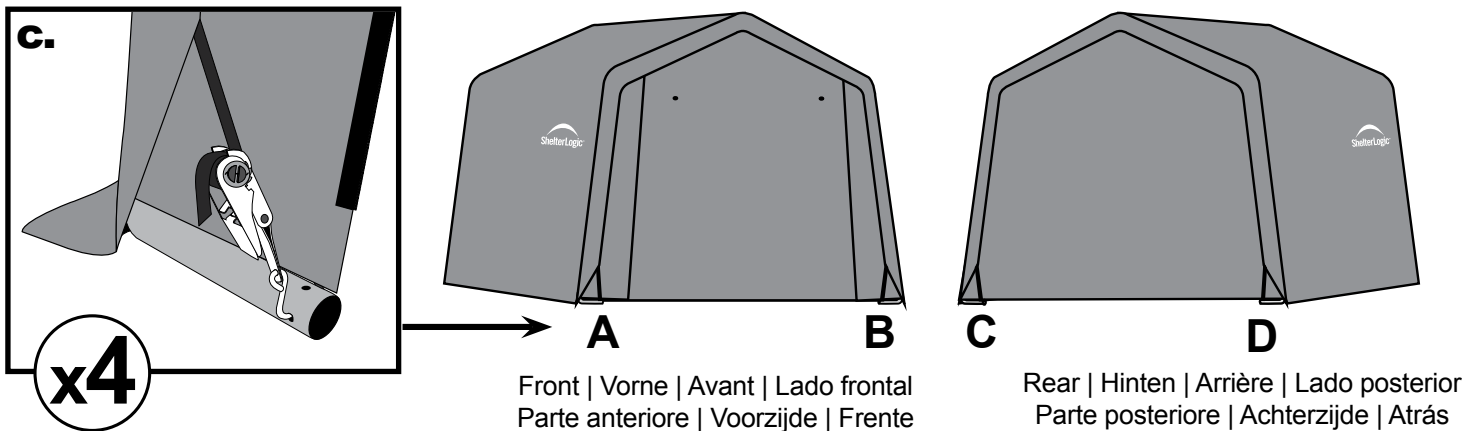

18.

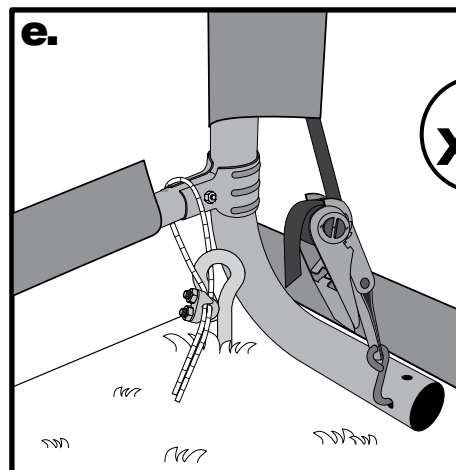
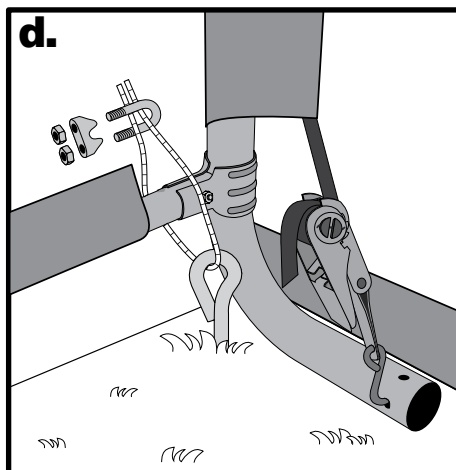
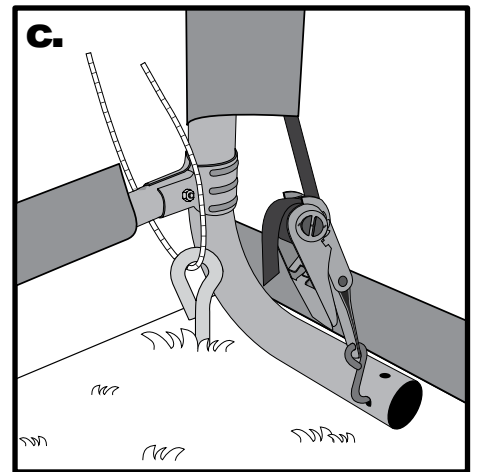
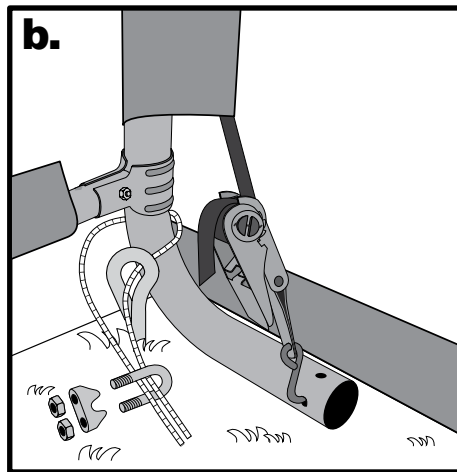
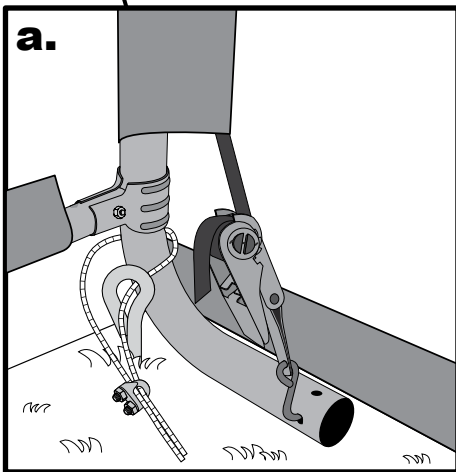
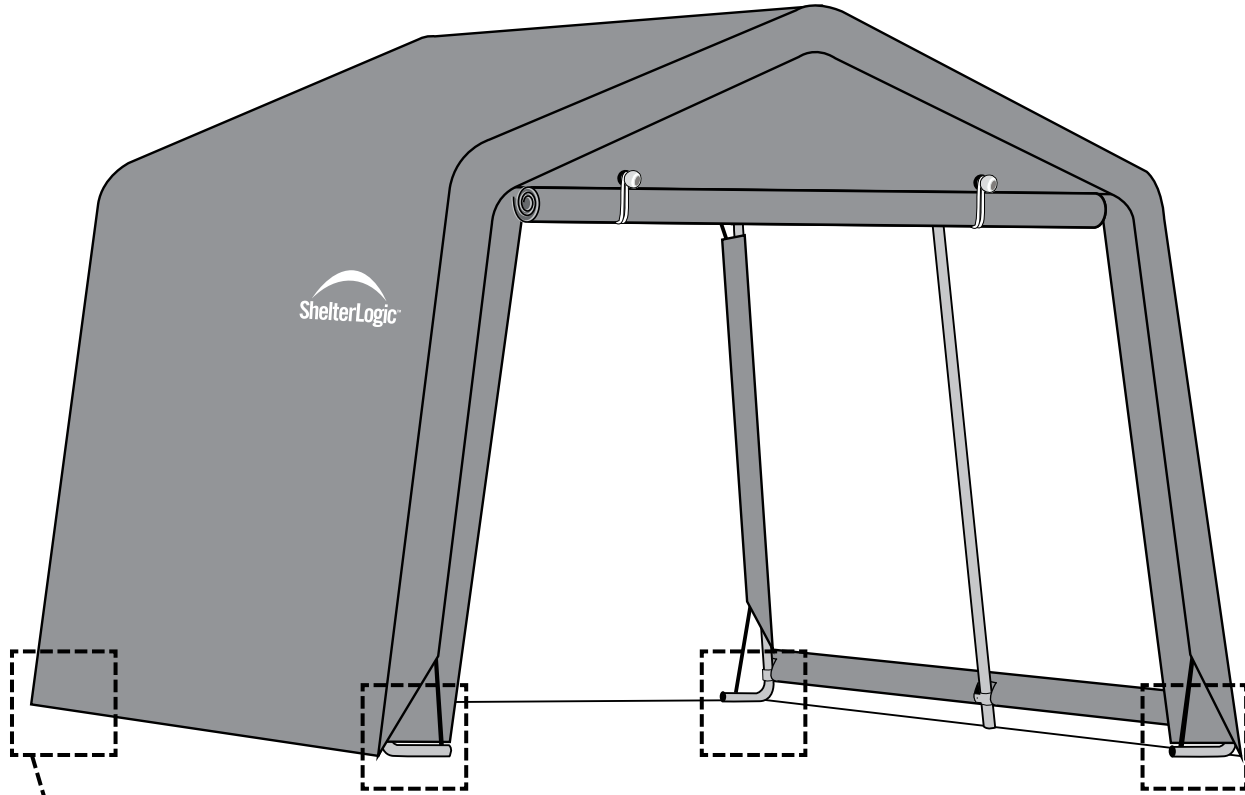
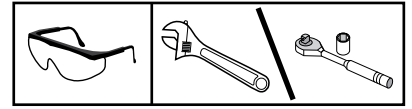

19.



a.

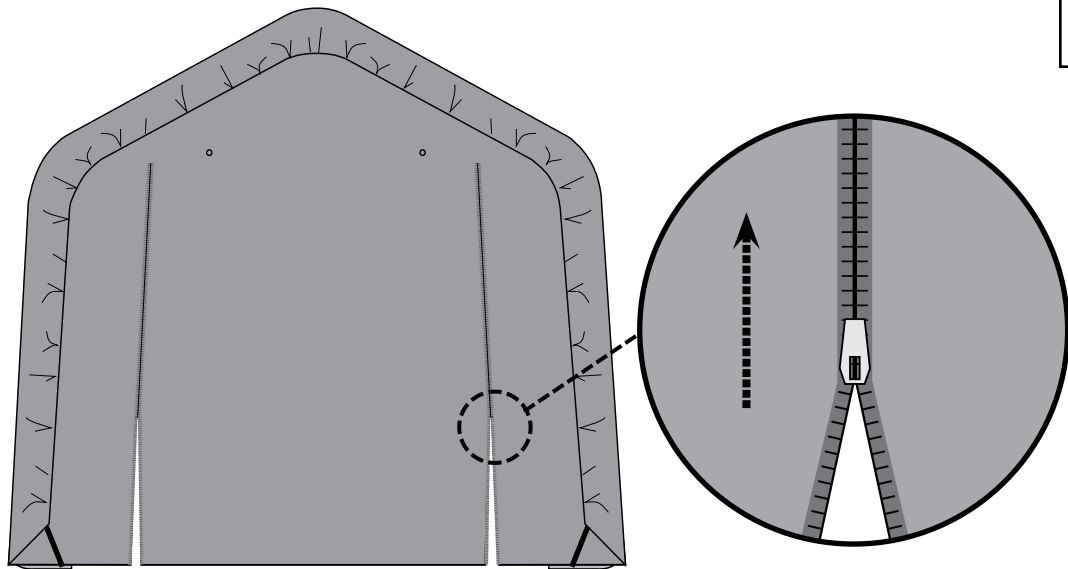

b.

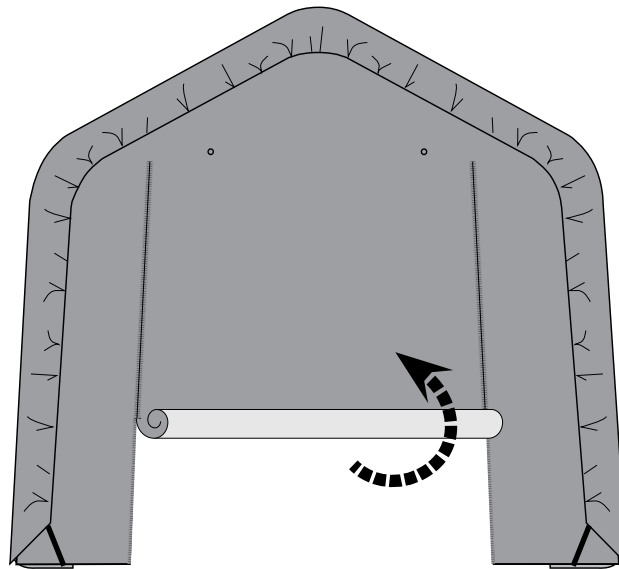

c.

