

*Tuvalu 1*  
*Art. Nr. 285100*  
*1/6*



2.08.2019

Art. Nr. 285100

Groundplan - Grundplan - Plan de masse - Planimetria - Plattegrond  
- Põhiplaan

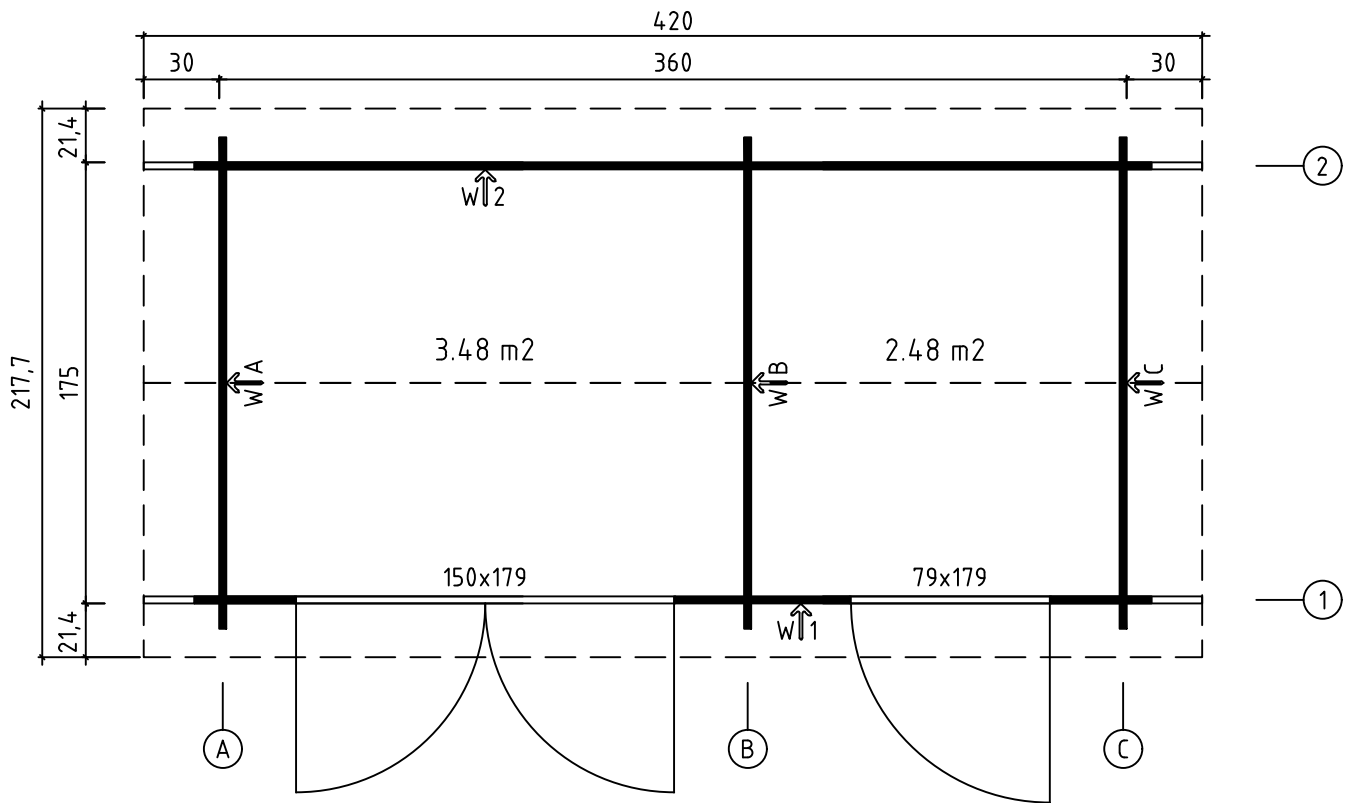

Foundation - Fundament - Fondation - Fondamenta - Fundering -  
Immutatud alusraam

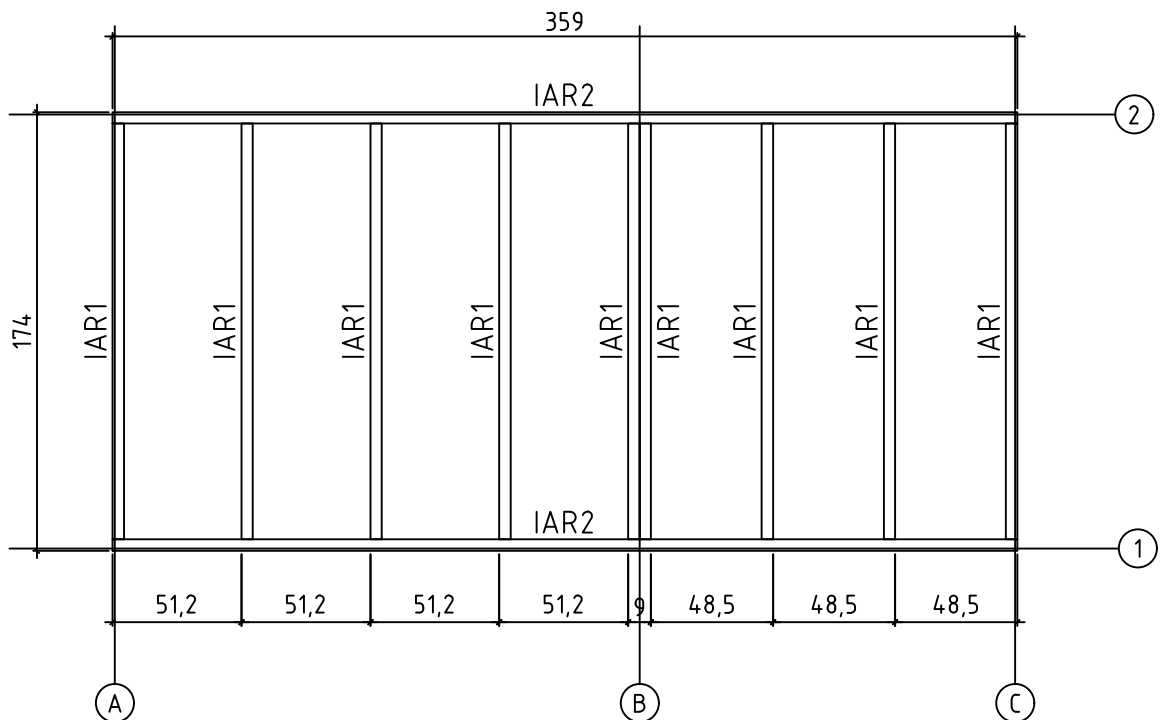





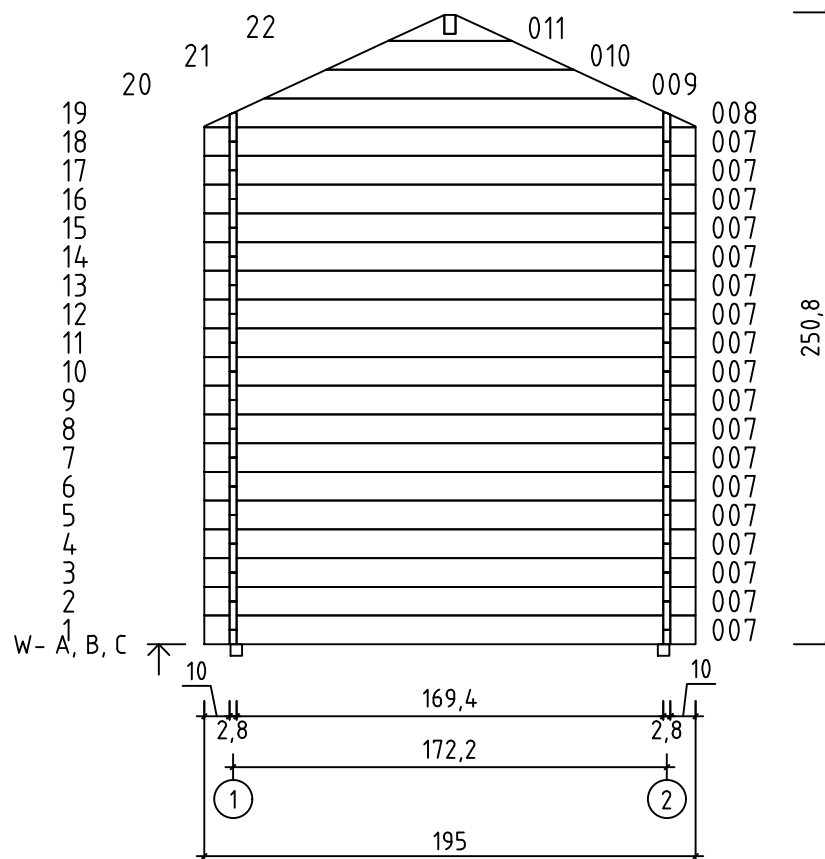
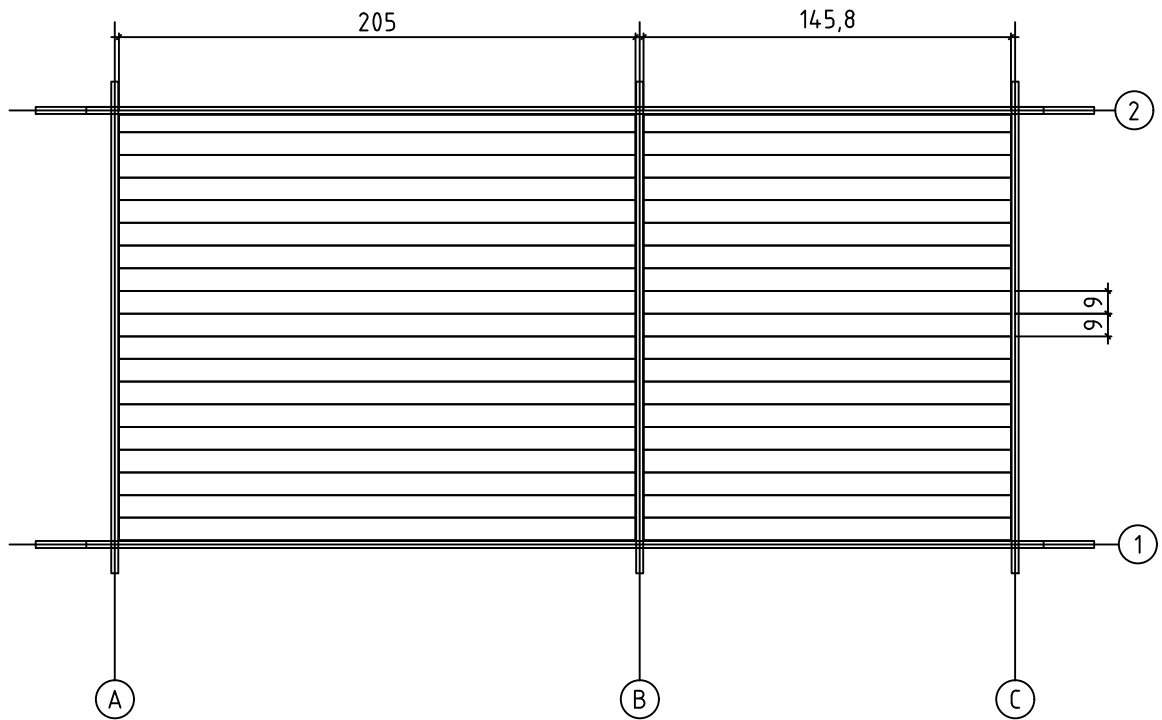



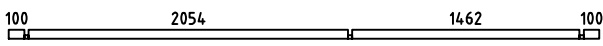

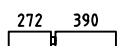
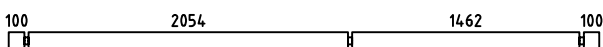
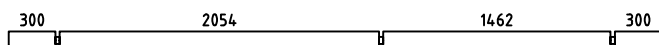
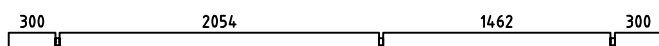
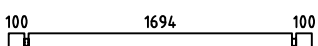
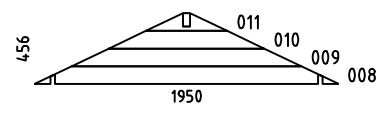
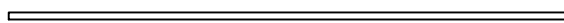
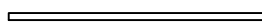
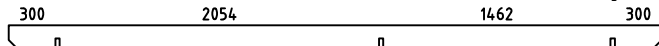

Art. Nr. 285100

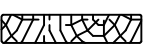

Floor boards - Fussbodenbretter - Plan pose plancher - Pavimento -  
Vloerhout - Põrandalaudis

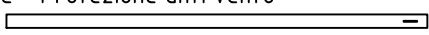
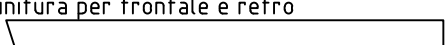



Pos	02.08.2019 Piece list - Stückliste - Liste des pièces - Elementi - Stuklijst - Tükitalabel Art. Nr. 285100 5/6	Q	P (mm)	L (mm)
001		2	28x57	3800
002		32	28x114	400
003		16	28x114	690
004		18	28x114	3800
005		1	28x120	4200
006		1	28x120	4200
007		54	28x114	1950
WA-1 WB-1 WC-1		1 1 1		
IAR2	Foundation - Fundament - Fondation - Fondamenta - Fundering - Immutatud alusraam 	2	45x45	3590
IAR1	Foundation - Fundament - Fondation - Fondamenta - Fundering - Immutatud alusraam 	9	45x45	1650
A-PR1	Roof beam - Dachbalken - Panne de toit - Perlina del tetto - Gordingen / dakbalk - Pärilin 	1	44x140	4200
	Floor boards - Fussbodenbretter - Lamé de plancher - Pavimento - Vloerhout - Põrandalaud 	19	90x18	2050
	Floor boards - Fussbodenbretter - Lamé de plancher - Pavimento - Vloerhout - Põrandalaud 	19	90x18	1458
DB	Roof boards - Dachbretter - Voliges - Perlina per tetto - Dakhout - Katuselaud 	94	90x18	1200
	Floor fillet - Fussbodenteiste - Corniere de finition du plancher - Finitura per pavimento (battisco pa) - Vloerafwerkljst - Põrandaliist 		18x18	13.78
DPL	Roofing felt fillet - Dachpappenleiste - Baguette de fixation du feutre bitumeux - Asse per fissaggio guaina bituminosa - Afdekljst asfaltpapier - Katusepapiiist 	4	18x58	1250
TB	Fascia board - Traufbrett - Bandeau de toit - Finitura lati tetto - Gevelljst Räästalaud 	2	18x90	4200
DRV	Roof edge reinforcement - Dachrandverstärkung - Corniere de renfort de bord de toit - Rinforzo x tetto - Dakrand versterking - Räästatugevdus 	2	28x34	4200
KFS-1	Storm protection - Sturmleiste - Latte anti-tempete - Protezione anti vento - Stormverankering / beveiliging - Tormikinnitusliist 	4	22x45	2500
GL	Gable moulding - Giebelleiste - Planche de rive - Finitura per frontale e retro del tetto - Gevelljst - Viilulaud 	4	18x120	1250
HS8	Screw for gable segment - Schrauben für deckblatt - Vis pour fixation losange de finition - Viti x frontali tetto - Schroef voor gevelpunt segment - Kruvi rombile 	4	3.5x35	
HS9	Screw for gable moulding - Schrauben für giebelleiste - Vis pour fixation planche de rive - Vite per fissare finiture davanti e dietro del tetto - Schroef voor gevelljst - Kruvi viilulauale 	16	3.5x50	

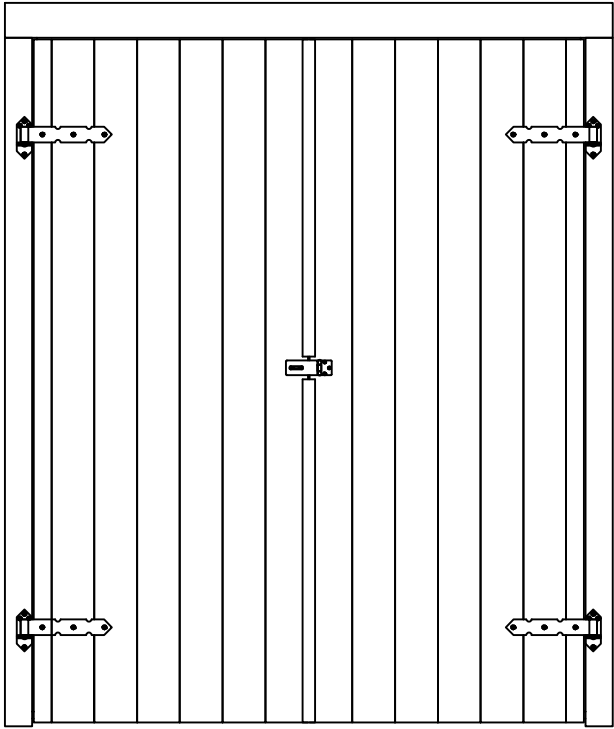
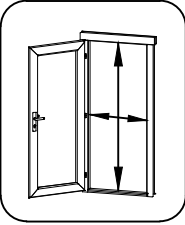
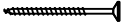
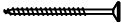
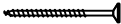

Pos	15.09.2016	Piece list - Stückliste - Liste des pièces - Elementi - Stuklijst - Tükítabel 1500x1790 TUL.1.100.IVP.Md TZ	1/1	Q	P (mm)	L (mm)
						
	 1400x1722 mm					
HS7	Screw for padlock hasp - Schrauben für panzer überfalle - Vis pour loquet pour cadenas - Viti per lucchetto a fermaglio - Schroef tbv slot - Kruvi tabakrambile		7	3.5x20		
HS4	Screw for door fillet - Schraube zur befestigung türleiste - Vis pour fixation baguette d'arret de porte - Viti per massellino della porta - Schroef voor deurlijst - Kruvi ukse kokkuvaltšiliistule		5	3x30		
HS16	Screw for door jamb - Schraube für türrahmen - Vis de fixation partie haute avec montants du cadre de porte - Viti x fissaggio montanti porte - Schroef voor deurkozijn - Kruvi ukse lengile		4	5x90		
TT	Door hinges - Torriegel - Gonds de porte - Cerniere - Deur scharnier - T-hing		4			
	Padlock hasp - Panzer überfalle - Loquet pour cadenas - Lucchetto a fermaglio - Hangslot vergrendeling - Tabakramp		1			

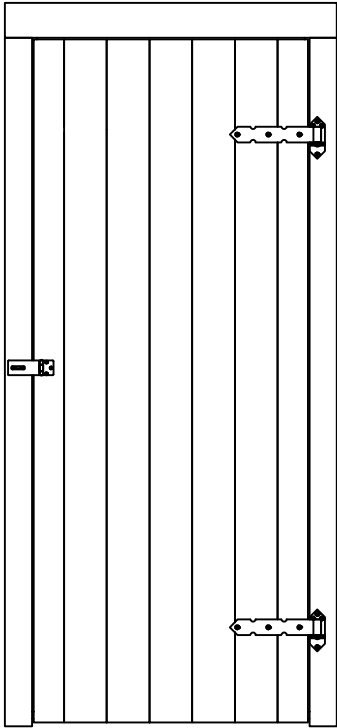
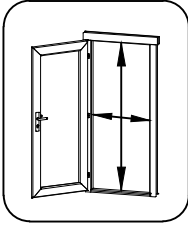
Pos	15.09.2016	Piece list - Stückliste - Liste des pièces - Elementi - Stuklijst - Tükitabel 790x1790 UL.1.100.IVP.Md TZ	1/1	Q	P (mm)	L (mm)
		  <p>690x1722 mm</p>				

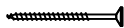
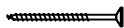
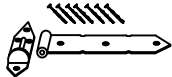
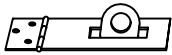
HS7	Screw for padlock hasp - Schrauben für panzer überfalle - Vis pour loquet pour cadenas - Viti per lucchetto a fermaglio - Schroef tbv slot - Kruvi tabakrambile		7	3.5x20		
HS16	Screw for door jamb - Schraube für türrahmen - Vis de fixation partie haute avec montants du cadre de porte - Viti x fissaggio montanti porte - Schroef voor deurkozijn - Kruvi ukse lengile		4	5x90		
TT	Door hinges - Torriegel - Gonds de porte - Cerniere - Deur scharnier - T-hing		2			
	Padlock hasp - Panzer überfalle - Loquet pour cadenas - Lucchetto a fermaglio - Hangslot vergrendeling - Tabakramp		1			